



Product Selection Guide

Size and Performance Data.....SD-2

Features and Options.....SD-3

Combination Assemblies.....SD-5

Glazing Performance.....SD-6

Grille Types

Grille ProfilesSD-8

Grille PatternsSD-9

Size Tables.....SD-10

Special Sizes and DimensionsSD-16

Design DataSD-17

Detailed Product Descriptions.....SD-19

Unit SectionsSD-20

Handle Hardware DimensionsSD-26

Document Navigation Tips:

Items listed in the table of contents above are active links that will take you to the corresponding page. The Pella logo on each page is a link back to this table of contents. Bookmarks are also included in this PDF document and are available as an additional navigation option.

Supporting documents for this product:

Test Reports:

https://media.pella.com/professional/adm/CertificationReports/Test_Reports_AS-Clad.pdf?utm_source=pdfdoc

CSI Specs (readable using Microsoft Word or other text editing application):

https://media.pella.com/professional/adm/Wood-CSI_Specs/08262-PR.rtf?utm_source=pdfdoc

AIA Masterspec

(readable using Microsoft Word or other text editing application):

[AIA Masterspec: https://media.pella.com/professional/adm/Wood-CSI_Specs/Masterspec/085200_fl.doc?utm_source=pdfdoc](https://media.pella.com/professional/adm/Wood-CSI_Specs/Masterspec/085200_fl.doc?utm_source=pdfdoc)

Detailed Product Description

(readable using Microsoft Word or other text editing application):

https://media.pella.com/professional/adm/Clad-Wood/PR-SlidingDoor.rtf?utm_source=pdfdoc

Size Tables (requires appropriate CAD software to read and use):

https://media.pella.com/professional/adm/Clad-Wood/LS-PR-SPD-ELEV_D.dwg?utm_source=pdfdoc

CAD cross sections (requires appropriate CAD software to read and use):

https://media.pella.com/professional/adm/Clad-Wood/LS-PR_SD_XSEC_D.dwg?utm_source=pdfdoc

3D & BIM (requires appropriate software to read and use):

https://media.pella.com/professional/adm/RevitFiles/PR-Revit/Door-Sliding_Door-Pella-Reserve-Traditional.zip?utm_source=pdfdoc

Sketchup (requires appropriate software to read and use):

https://media.pella.com/professional/adm/Clad-Wood/PellaSKP_PellaReserve_Traditional_Sliding_Door.zip?utm_source=pdfdoc

Combination Recommendations:

https://media.pella.com/professional/adm/Clad-Wood/D_Combinations.pdf?utm_source=pdfdoc

Installation Details:

https://media.pella.com/professional/adm/Clad-Wood/F_InstallationDetails.pdf?utm_source=pdfdoc

Microsoft and Microsoft Word are registered trademarks of Microsoft Corp.



Pella® Reserve™ Traditional Sliding Patio Door

Size and Performance Data

Sizes	
Standard Door Sizes	●
Standard Fixed Frame Direct Set Transom Sizes	●
Fixed Sash and Frame	●
Wide Stile Fixed Sash and Frame	●
Special Sizes	●
Custom Sizes	●
Door Heights	
6' 8"	●
6' 10"	●
8'	●
9'	●
10'	●

Performance ₁	
Standard	
Meets or Exceeds AAMA/WDMA Ratings	SD-R20 – LC50 Hallmark Certified 411-H-1520
Air Infiltration (cfm/ft ² of frame @ 1.57 psf wind pressure)	0.30
Water Resistance	3.13 – 7.52 psf
Design Pressure	20 – 50 psf
Other Performance Criteria	
Forced Entry Resistance Level (Minimum Security Grade) ₂	40
Operating Force (lb.) Initiate Motion / Maintain Motion (of Hallmark tested size and glazing) ₃	30/20

Sound Transmission Class / Outdoor-Indoor Transmission Class

Product	Frame Size Tested ₄	Glazing System				STC Rating	OITC Rating
		Overall Glazing Thickness	Exterior Glass Thickness	Interior Glass Thickness	Third Pane Thickness		
Clad Sliding Door	No Grilles						
	71.9" x 79.7" (Fixed-Vent)	3/4"	3 mm	3 mm	–	28	24
	71.9" x 79.7" (Fixed-Vent)	3/4"	4 mm	6 mm	–	31	27
	71.9" x 79.7" (Fixed-Vent)	7/8"	5 mm	7.6 mm PVB	–	33	29
	71.9" x 79.7" (Fixed-Vent)	7/8"	5 mm	10 mm PVB	–	32	29
	71.9" x 79.7" (Fixed-Vent)	1-3/8"	4 mm	4 mm	4 mm	30	24

(–) = Not Available

(1) Maximum performance for single unit when glazed with the appropriate glass thickness. See Design Data pages in this section for specific product performance class and grade values.

(2) The higher the level, the greater the product's ability to resist forced entry.

(3) Glazing configurations may result in higher operational forces.

(4) ASTM E 1425 defines standard sizes for acoustical testing. Ratings achieved at that size are representative of all sizes of the same configuration.



Pella® Reserve™ Traditional Sliding Patio Door

Features and Options

Standard	Options / Upgrades
Glazing	
Glazing Type	
Dual-Pane Insulating Glass	Triple-pane Insulating Glass
Insulated Glass Options/Low-E Types	
Advanced Low-E	SunDefense™ Low-E
	SunDefense+ Low-E
	AdvancedComfort Low-E
	NaturalSun Low-E
	NaturalSun+ Low-E
Clear (no Low-E coating)	
Additional Glass Options	
Tempered Glass	Obscure Glass ₁
	Tinted Glass (Bronze, Gray and Green)
	Non-Impact Laminated
Gas Fill/High Altitude	
Argon	High altitude
Wood Types	
Pine	—
Exterior	
EnduraClad® aluminum-clad	EnduraClad Plus aluminum-clad
Cladding Colors	
Standard colors	Feature Colors, Custom Colors ₁
Interior	
Unfinished wood	Factory primed, Factory prefinished paint, Factory prefinished stain
Hardware	
Interior	
Champagne, White, Brown, Matte Black	Satin Brass, Satin Nickel, Oil-Rubbed Bronze, Distressed Bronze, Distressed Nickel, Polished Chrome
Exterior	
Handle matches cladding	Satin Brass, Satin Nickel, Oil-Rubbed Bronze, Distressed Bronze, Distressed Nickel, Polished Chrome
Locking system	
Multi-Point	—
Key Lock	—
—	Vent Lock
Grilles	
Integral Light Technology® Grilles	
—	Traditional, Prairie, Top Row, Cross, Custom
Grilles-Between-the-Glass	
—	Traditional, Prairie, Top Row ₁ , Cross, Custom-Equally Divided
Screens	
Flat Screen	Tuffscreen® Sliding Screen

(1) Contact your local Pella sales representative for current designs and color options.

Tuffscreen is a trademark of Phifer Incorporated.



FEATURES AND OPTIONS

Interior Frame Finish Colors

Interior Color / Finish	Pella Reserve Interior Frame
Factory prefinished White, Linen White or Prime	Wood Trim and Jamb Covers finish matched to panel interior finish selection. (Covers a white aluminum frame)
Factory prefinished Bright White	Wood Trim and Jamb Covers finish matched to panel interior finish selection. (Covers a classic white aluminum frame)
Factory prefinished Black	Wood Trim and Jamb Covers finish matched to panel interior finish selection. (Covers a black aluminum frame)
Unfinished, factory prefinished Stain	Wood Trim and Jamb Covers finish matched to panel interior finish selection. (Covers a black aluminum frame)

Vent Lock Hardware Finish Colors

Interior Color / Finish	Vent Lock Hardware Finish
Factory prefinished White, Bright White, Linen White or Primed	White Painted
Factory prefinished Stain Black, Golden Oak, Early American, Provincial, Dark Mahogany, or Charcoal	Black Painted
Unfinished or Factory prefinished Natural Stain	Select White or Black Painted

Screen Hardware Colors

Screen frame will match exterior cladding color, Screen hardware is set according to the exterior finish chosen.

Exterior Clad Color	Screen Hardware Color
White, Classic White, Vanilla Cream, Poplar White	White
Brown, Portobello, Auburn Brown, French Roast	Brown
Fossil, Soft Linen, Almond, Sand Dune, Putty, Tan	Fossil
Wolf Gray, Pearl Gray, Morning Sky Gray, Eldridge Gray	Morning Sky Gray
Black, Iron Ore, Satin Steel, Matte Gray, Brick Red, Spice Red, Hartford Green, Sage, Blue Ash, Frost Blue, Deep Olive, Summer Sage, Hemlock, Naval, Stormy Blue	Black



Combination Assemblies

Combinations are a great way to create visual interest in any project. A combination is an assembly formed by two or more separate windows or doors whose frames are mullioned together directly or using a reinforcing mullion.

Pella window combinations are available in an endless variety of arrangements. Below are examples of typical sliding door combinations.

Factory assembled mullions are limited to factory assembled two panel doors ≤ 96 inches.

The factory mullioned units combined must be ≤ 103 " High and ≤ 144 " Wide.

Any two panel doors greater than 96 inches or using knock-down-frames will require field mullion assembly.

All 3 and 4-panel doors or any units using knock down frames will require field mullion assembly.

Refer to Combinations section for requirements and limitations or contact your local Pella sales representative for more information.

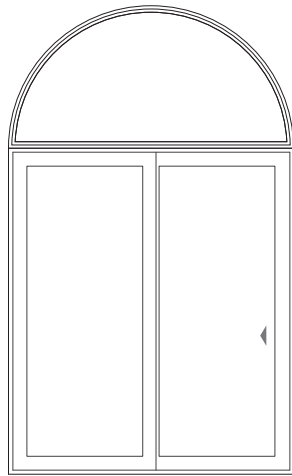

Half Circle over
Sliding Fixed/Vent

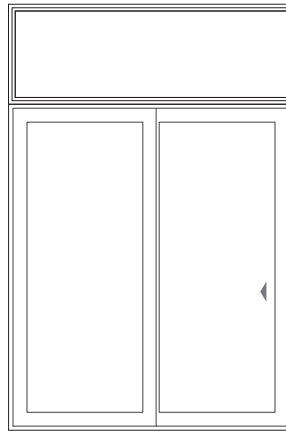

Transom over
Sliding Fixed/Vent

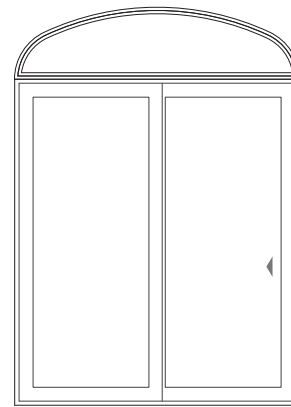

Elliptical over
Sliding Fixed/Vent



Pella® Reserve™ Traditional Sliding Patio Door

Glazing Performance - Total Unit

Glazing Thickness	Type of Glazing	NFRC Certified Product #	Glass (mm)		Gap Fill	Performance Values ¹				Shaded Areas Meet ENERGY STAR® Performance Criteria in Zones Shown					
			Ext.	Int.		U-Factor	SHGC	VLT %	CR	U. S.				Canada ₂	
										Zone				ER	Zone
										N	NC	SC	S	CA	
Dual-Pane Glazing															
3/4"	Clear IG	PEL-N-304-00001-00001	3	3	air	0.47	0.58	0.61	42						
	with grilles-between-the-glass	PEL-N-304-00001-00002				0.47	0.51	0.53	42						
	with integral grilles	PEL-N-304-00001-00003				0.47	0.51	0.53	42						
3/4"	Advanced Low-E IG	PEL-N-304-00019-00001	3	3	argon	0.30	0.28	0.52	55						
	with grilles-between-the-glass	PEL-N-304-00019-00002				0.30	0.25	0.45	55						
	with integral grilles	PEL-N-304-00019-00003				0.30	0.25	0.45	55						
3/4"	SunDefense™ Low-E IG	PEL-N-304-00070-00001	3	3	argon	0.30	0.21	0.48	55						
	with grilles-between-the-glass	PEL-N-304-00070-00002				0.30	0.18	0.42	55						
	with integral grilles	PEL-N-304-00070-00003				0.30	0.18	0.42	55						
3/4"	SunDefense+™ Low-E IG	PEL-N-304-00112-00001	3	3	argon	0.26	0.20	0.47	45	N	NC	SC	S		
	with grilles-between-the-glass	PEL-N-304-00112-00002				0.26	0.18	0.41	45	N	NC	SC	S		
	with integral grilles	PEL-N-304-00112-00003				0.26	0.18	0.41	45	N	NC	SC	S		
3/4"	AdvancedComfort™ Low-E IG	PEL-N-304-00100-00001	3	3	argon	0.26	0.27	0.51	45	N	NC				
	with grilles-between-the-glass	PEL-N-304-00100-00002				0.26	0.24	0.44	45	N	NC				
	with integral grilles	PEL-N-304-00100-00003				0.26	0.24	0.44	45	N	NC				
3/4"	NaturalSun™ Low-E IG	PEL-N-304-00088-00001	3	3	argon	0.31	0.51	0.59	54						
	with grilles-between-the-glass	PEL-N-304-00088-00002				0.31	0.45	0.51	54						
	with integral grilles	PEL-N-304-00088-00003				0.31	0.45	0.51	54						
3/4"	NaturalSun+™ Low-E IG	PEL-N-304-00124-00001	3	3	argon	0.27	0.47	0.57	44						
	with grilles-between-the-glass	PEL-N-304-00124-00002				0.27	0.41	0.50	44						
	with integral grilles	PEL-N-304-00124-00003				0.27	0.41	0.50	44						
Dual-Pane Tinted Glazing															
3/4"	Bronze Advanced Low-E IG	PEL-N-304-00025-00001	5	5	argon	0.32	0.25	0.33	52						
	with grilles-between-the-glass	PEL-N-304-00026-00001				0.33	0.22	0.28	52						
	with integral grilles	PEL-N-304-00027-00001				0.33	0.22	0.28	52						
3/4"	Gray Advanced Low-E IG	PEL-N-304-00028-00001	5	5	argon	0.32	0.23	0.28	52						
	with grilles-between-the-glass	PEL-N-304-00029-00001				0.33	0.20	0.24	52						
	with integral grilles	PEL-N-304-00030-00001				0.33	0.20	0.24	52						
3/4"	Green Advanced Low-E IG	PEL-N-304-00031-00001	5	5	argon	0.32	0.23	0.28	52						
	with grilles-between-the-glass	PEL-N-304-00032-00001				0.33	0.20	0.24	52						
	with integral grilles	PEL-N-304-00033-00001				0.33	0.24	0.38	52						

R-Value = 1/U-Factor
 SHGC = Solar Heat Gain Coefficient
 VLT % = Visible Light Transmission
 CR = Condensation Resistance
 ER = Canadian Energy Rating

(1) Glazing performance values are calculated for Pine using NFRC 100, NFRC 200 and NFRC 500. Thermal performance of other wood species may vary. ENERGY STAR® values are updated to 2023 (Version 7) criteria.

(2) The values shown are based on Canada's updated ENERGY STAR® 2020 initiative.

Visit www.energystar.gov for Energy Star guidelines.

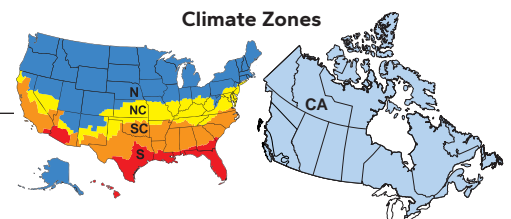



Pella® Reserve™ Traditional Sliding Patio Door

Glazing Performance - Total Unit

Glazing Thickness	Type of Glazing	NFRC Certified Product #	Glass (mm)			Gap Fill	Performance Values ¹				Shaded Areas Meet ENERGY STAR® Performance Criteria in Zones Shown					
			Ext.	Middle	Int.		U-Factor	SHGC	VLT %	CR	U. S.		Canada ²			
											Zone		ER	Zone		
Triple-Pane Glazing											N	NC	SC	S	CA	
1-3/8"	Advanced Low-E IG	PEL-N-304-00205-00001	4	4	4	argon	0.22	0.25	0.45	63	N	NC				
	with grilles-between-the-glass	PEL-N-304-00206-00001					0.22	0.22	0.39	63	N	NC	SC	S		
1-3/8"	SunDefense™ Low-E IG	PEL-N-304-00228-00001	4	4	4	argon	0.21	0.19	0.42	63	N	NC	SC	S		
	with grilles-between-the-glass	PEL-N-304-00229-00001					0.22	0.17	0.36	63	N	NC	SC	S		
1-3/8"	NaturalSun Low-E IG	PEL-N-304-00245-00001	4	4	4	argon	0.22	0.41	0.51	63					36	CA
	with grilles-between-the-glass	PEL-N-304-00246-00001					0.22	0.36	0.45	63	N	NC				

R-Value = 1/U-Factor
 SHGC = Solar Heat Gain Coefficient
 VLT % = Visible Light Transmission
 CR = Condensation Resistance
 ER = Canadian Energy Rating

(1) Glazing performance values are calculated for Pine using NFRC 100, NFRC 200 and NFRC 500. Thermal performance of other wood species may vary. ENERGY STAR® values are updated to 2023 (Version 7) criteria.

(2) The values shown are based on Canada's updated ENERGY STAR® 2020 initiative.

Visit www.energystar.gov for Energy Star guidelines.

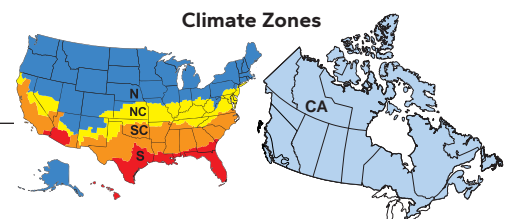



Grille Profiles

Traditional Style Collection - Integral Light Technology®

Putty Glaze and Ogee Grilles
Clad Exterior - Wood Interior

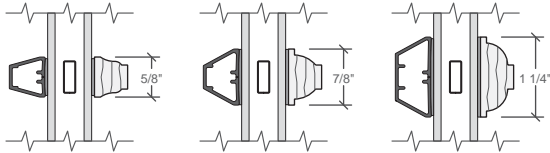

Ogee Grilles
Clad Exterior - Wood Interior

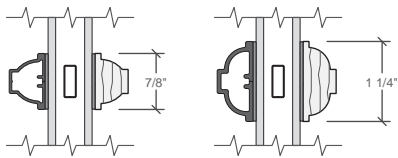

Grilles-Between-the-Glass

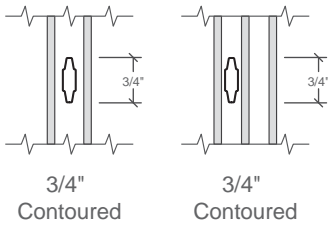



Grille Patterns

Integral Light Technology® Grilles

Prairie Lite Patterns

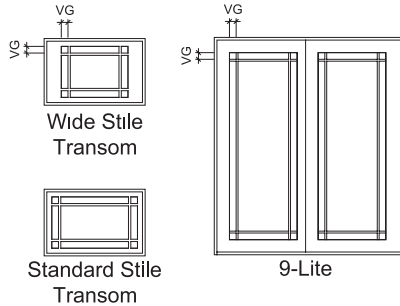

Standard corner light dimension for Prairie patterns = 3-1/2" VG.

Other Available Patterns

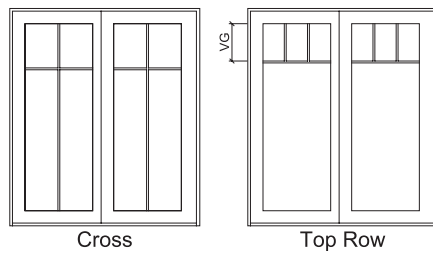

Standard visible glass to separator bar = 14" or half of total visible glass height, whichever is smaller.

Grilles-Between-the-Glass

Prairie Lite Patterns

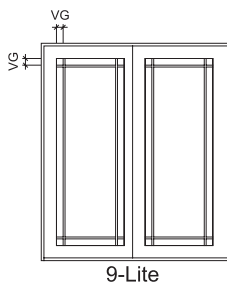

Prairie
– Standard corner lite dimension = 3-1/2" VG.

Other Available Patterns

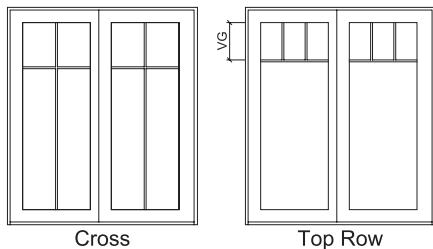

Cross
– Horizontal bar is 1/4 of visible glass from the top in door panels.
– Not available in transoms.

Top Row
– Horizontal bar may be ordered 12", 14" or 16" from the top VG.
– Transoms with frame heights ≥ 21", the horizontal bar will be positioned at 1/2 the visible glass height.
– Top Row not available in transoms with frame height <21".

For traditional patterns, see size tables.

VG = Visible Glass

Lite dimensions noted can vary.

Custom configurations are available; for details contact your local Pella sales representative.



Pella® Reserve™ Traditional Sliding Patio Door

Size Tables

6' 8" Two-Panel Fixed-Vent

Opening	5' 0" (1 524)	6' 0" (1 829)	7' 0" (2 134)	8' 0" (2 438)	10' 0" (3 048)
Frame	4' 11 1/4" (1 505)	5' 11 1/4" (1 810)	6' 11 1/4" (2 115)	7' 11 1/4" (2 419)	9' 11 1/4" (3 029)

6' 8" Three-Panel Fixed-Vent-Fixed

Opening	7' 7" (2 311)	9' 1" (2 769)	10' 7" (3 226)	12' 1" (3 683)	15' 1" (4 597)
Frame	7' 6 1/4" (2 292)	9' 0 1/4" (2 750)	10' 6 1/4" (3 207)	12' 0 1/4" (3 664)	15' 0 1/4" (4 578)

6' 8" Four-Panel Fixed-Vent-Vent-Fixed

Opening	9' 10" (2 997)	11' 10" (3 606)	13' 10" (4 216)	15' 10" (4 826)
Frame	9' 9 1/4" (2 978)	11' 9 1/4" (3 588)	13' 9 1/4" (4 197)	15' 9 1/4" (4 807)

6' 8" Four-Panel Fixed-Vent-Vent-Fixed (Cont.)

Opening	19' 10" (6 045)
Frame	19' 9 1/4" (6 026)

Not to scale.

All doors are glazed with tempered glass.

Two panel doors—Fixed-Vent (OX), right panel opens, left panel is fixed. Units open in the direction of the arrow as viewed from the exterior.

Vent-Fixed (XO) doors are also available.

Fixed-Vent-Fixed (OXO) vent to the right only.



Pella® Reserve™ Traditional Sliding Patio Door

Size Tables

6' 10" Two-Panel Fixed-Vent

Opening	5' 0" (1 524)	6' 0" (1 829)	7' 0" (2 134)	8' 0" (2 438)	10' 0" (3 048)
Frame	4' 11 1/4" (1 505)	5' 11 1/4" (1 810)	6' 11 1/4" (2 115)	7' 11 1/4" (2 419)	9' 11 1/4" (3 029)

6' 10" (2 083)

6' 9 1/2" (2 070)

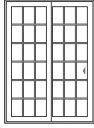

2 Panel (OX)
6082

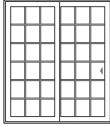

2 Panel (OX)
7282

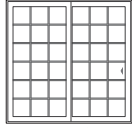

2 Panel (OX)
8482

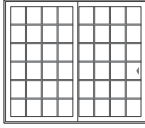

2 Panel (OX)
9682

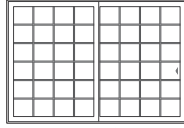

2 Panel (OX)
12082

6' 10" Three-Panel Fixed-Vent-Fixed

Opening	7' 7" (2 311)	9' 1" (2 769)	10' 7" (3 226)	12' 1" (3 683)	15' 1" (4 597)
Frame	7' 6 1/4" (2 292)	9' 0 1/4" (2 750)	10' 6 1/4" (3 207)	12' 0 1/4" (3 664)	15' 0 1/4" (4 578)

6' 10" (2 083)

6' 9 1/2" (2 070)

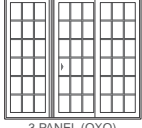

3 PANEL (OXO)
9082

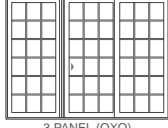

3 PANEL (OXO)
10882

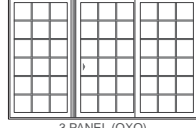

3 PANEL (OXO)
12682

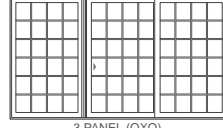

3 PANEL (OXO)
14482

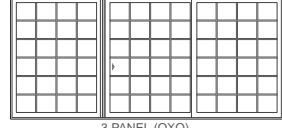

3 PANEL (OXO)
18082

6' 10" Four-Panel Fixed-Vent-Vent-Fixed

Opening	9' 10" (2 997)	11' 10" (3 606)	13' 10" (4 216)	15' 10" (4 826)
Frame	9' 9 1/4" (2 978)	11' 9 1/4" (3 588)	13' 9 1/4" (4 197)	15' 9 1/4" (4 807)

6' 10" (2 083)

6' 9 1/2" (2 070)

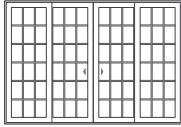

4 PANEL (OXOX)
11782

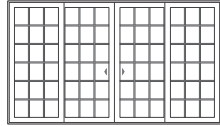

4 PANEL (OXOX)
14182

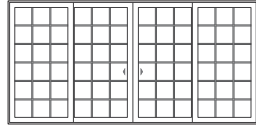

4 PANEL (OXOX)
16582

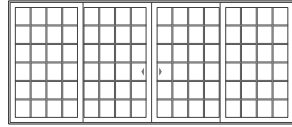

4 PANEL (OXOX)
18982

6' 10" Four-Panel Fixed-Vent-Vent-Fixed (Cont.)

Opening	19' 10" (6 045)
Frame	19' 9 1/4" (6 026)

6' 10" (2 083)

6' 9 1/2" (2 070)

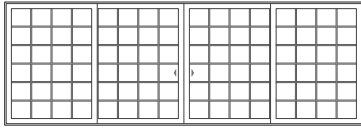

4 PANEL (OXOX)
23782

Not to scale.

All doors are glazed with tempered glass.

Two panel doors—Fixed-Vent (OX), right panel opens, left panel is fixed. Units open in the direction of the arrow as viewed from the exterior.

Vent-Fixed (XO) doors are also available.

Fixed-Vent-Fixed (OXO) vent to the right only.



Pella® Reserve™ Traditional Sliding Patio Door

Size Tables

8' 0" Two-Panel Fixed-Vent

Opening	5' 0" (1 524)	6' 0" (1 829)	7' 0" (2 134)	8' 0" (2 438)	10' 0" (3 048)
Frame	4' 11 1/4" (1 505)	5' 11 1/4" (1 810)	6' 11 1/4" (2 115)	7' 11 1/4" (2 419)	9' 11 1/4" (3 029)

8' 0" (2 438)
7' 11 1/2" (2 426)

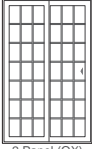
 2 Panel (OX)
6096

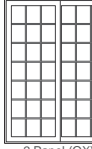
 2 Panel (OX)
7296

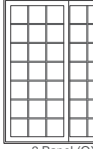
 2 Panel (OX)
8496

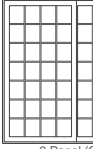

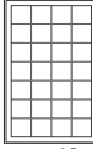
 2 Panel (OX)
9696



 2 Panel (OX)
12096

8' 0" Three-Panel Fixed-Vent-Fixed

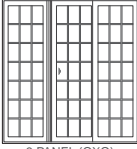
Opening	7' 7" (2 311)	9' 1" (2 769)	10' 7" (3 226)	12' 1" (3 683)	15' 1" (4 597)
Frame	7' 6 1/4" (2 292)	9' 0 1/4" (2 750)	10' 6 1/4" (3 207)	12' 0 1/4" (3 664)	15' 0 1/4" (4 578)

8' 0" (2 438)
7' 11 1/2" (2 426)

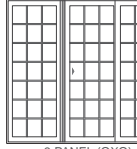
 3 PANEL (OXO)
9096

 3 PANEL (OXO)
10896

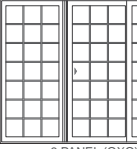
 3 PANEL (OXO)
12696

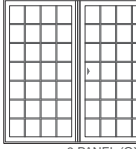

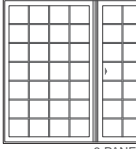
 3 PANEL (OXO)
14496



 3 PANEL (OXO)
18096

8' 0" Four-Panel Fixed-Vent-Vent-Fixed

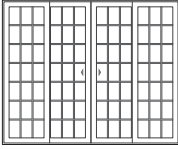
Opening	9' 10" (2 997)	11' 10" (3 606)	13' 10" (4 216)	15' 10" (4 826)
Frame	9' 9 1/4" (2 978)	11' 9 1/4" (3 588)	13' 9 1/4" (4 197)	15' 9 1/4" (4 807)

8' 0" (2 438)
7' 11 1/2" (2 426)

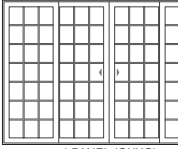
 4 PANEL (OXOX)
11796

 4 PANEL (OXOX)
14196

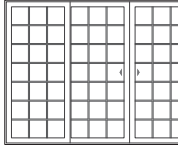

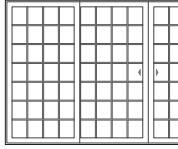
 4 PANEL (OXOX)
16596

 4 PANEL (OXOX)
18996

8' 0" Four-Panel Fixed-Vent-Vent-Fixed (Cont.)

Opening	19' 10" (6 045)
Frame	19' 9 1/4" (6 026)

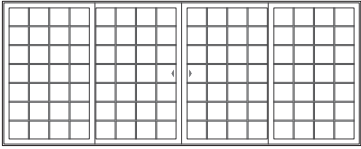
8' 0" (2 438)
7' 11 1/2" (2 426)

 4 PANEL (OXOX)
23796

Not to scale.

All doors are glazed with tempered glass.

Two panel doors—Fixed-Vent (OX), right panel opens, left panel is fixed. Units open in the direction of the arrow as viewed from the exterior.

Vent-Fixed (XO) doors are also available.

Fixed-Vent-Fixed (OXO) vent to the right only.



Pella® Reserve™ Traditional Sliding Patio Door

Size Tables

9' 0" Two-Panel Fixed-Vent

Opening	5' 0" (1 524)	6' 0" (1 829)	7' 0" (2 134)	8' 0" (2 438)	10' 0" (3 048)
Frame	4' 11 1/4" (1 505)	5' 11 1/4" (1 810)	6' 11 1/4" (2 115)	7' 11 1/4" (2 419)	9' 11 1/4" (3 029)
9' 0" 8' 11 1/2" (2 731)					
	2 Panel (OX)	2 Panel (OX)	2 Panel (OX)	2 Panel (OX)	2 Panel (OX)
	60108	72108	84108	96108	120108

9' 0" Three-Panel Fixed-Vent-Fixed

Opening	7' 7" (2 311)	9' 1" (2 769)	10' 7" (3 226)	12' 1" (3 683)	15' 1" (4 597)
Frame	7' 6 1/4" (2 292)	9' 0 1/4" (2 750)	10' 6 1/4" (3 207)	12' 0 1/4" (3 664)	15' 0 1/4" (4 578)
9' 0" 8' 11 1/2" (2 731)					
	3 PANEL (OXO)	3 PANEL (OXO)	3 PANEL (OXO)	3 PANEL (OXO)	3 PANEL (OXO)
	90108	108108	126108	144108	180108

9' 0" Four-Panel Fixed-Vent-Vent-Fixed

Opening	9' 10" (2 997)	11' 10" (3 606)	13' 10" (4 216)	15' 10" (4 826)
Frame	9' 9 1/4" (2 978)	11' 9 1/4" (3 588)	13' 9 1/4" (4 197)	15' 9 1/4" (4 807)
9' 0" 8' 11 1/2" (2 731)				
	4 PANEL (OXXO)	4 PANEL (OXXO)	4 PANEL (OXXO)	4 PANEL (OXXO)
	117108	141108	165108	189108

9' 0" Four-Panel Fixed-Vent-Vent-Fixed (Cont.)

Opening	19' 10" (6 045)
Frame	19' 9 1/4" (6 026)
9' 0" 8' 11 1/2" (2 731)	
	4 PANEL (OXXO)
	237108

Not to scale.

All doors are glazed with tempered glass.

Two panel doors—Fixed-Vent (OX), right panel opens, left panel is fixed. Units open in the direction of the arrow as viewed from the exterior.

Vent-Fixed (XO) doors are also available.

Fixed-Vent-Fixed (OXO) vent to the right only.



Pella® Reserve™ Traditional Sliding Patio Door

Size Tables

10' 0" Two-Panel Fixed-Vent

Opening	5' 0" (1 524)	6' 0" (1 829)	7' 0" (2 134)	8' 0" (2 438)	10' 0" (3 048)
Frame	4' 11 1/4" (1 505)	5' 11 1/4" (1 810)	6' 11 1/4" (2 115)	7' 11 1/4" (2 419)	9' 11 1/4" (3 029)

10' 0" (3 048)
9' 11 1/2" (3 035)

2 Panel (OX) 60120 2 Panel (OX) 72120 2 Panel (OX) 84120 2 Panel (OX) 96120 2 Panel (OX) 120120

10' 0" Three-Panel Fixed-Vent-Fixed

Opening	7' 7" (2 311)	9' 1" (2 769)	10' 7" (3 226)	12' 1" (3 683)	15' 1" (4 597)
Frame	7' 6 1/4" (2 292)	9' 0 1/4" (2 750)	10' 6 1/4" (3 207)	12' 0 1/4" (3 664)	15' 0 1/4" (4 578)

10' 0" (3 048)
9' 11 1/2" (3 035)

3 PANEL (OXO) 90120 3 PANEL (OXO) 108120 3 PANEL (OXO) 126120 3 PANEL (OXO) 144120 3 PANEL (OXO) 180120

10' 0" Four-Panel Fixed-Vent-Vent-Fixed

Opening	9' 10" (2 997)	11' 10" (3 606)	13' 10" (4 216)	15' 10" (4 826)
Frame	9' 9 1/4" (2 978)	11' 9 1/4" (3 588)	13' 9 1/4" (4 197)	15' 9 1/4" (4 807)

10' 0" (3 048)
9' 11 1/2" (3 035)

4 PANEL (OXXO) 117120 4 PANEL (OXXO) 141120 4 PANEL (OXXO) 165120 4 PANEL (OXXO) 189120

10' 0" Four-Panel Fixed-Vent-Vent-Fixed (Cont.)

Opening	19' 10" (6 045)
Frame	19' 9 1/4" (6 026)

10' 0" (3 048)
9' 11 1/2" (3 035)

4 PANEL (OXXO) 237120

Not to scale.

All doors are glazed with tempered glass.

Two panel doors—Fixed-Vent (OX), right panel opens, left panel is fixed. Units open in the direction of the arrow as viewed from the exterior.

Vent-Fixed (XO) doors are also available.

Fixed-Vent-Fixed (OXO) vent to the right only.



Pella® Reserve™ Traditional Sliding Patio Door

Size Tables

Transoms		(800) (781)	(953) (933)	(1 257) (1 238)	(1 524) (1 505)	(1 829) (1 810)	(2 438) (2 419)
Opening		2' 7 1/2"	3' 1 1/2"	4' 1 1/2"	5' 0"	6' 0"	8' 0"
Frame		2' 6 3/4"	3' 0 3/4"	4' 0 3/4"	4' 11 1/4"	5' 11 1/4"	7' 11 1/4"
(654) (635)	2' 1 3/4"						
	1' 5"						
	2' 1"						
(375) (356)	1' 2"						
(451) (432)	1' 5 3/4"						
(654) (635)	2' 1 3/4"						

Wide Stile

Wide Stile		(800) (781)	(953) (933)	(1 257) (1 238)	(1 524) (1 505)	(1 829) (1 810)	(2 438) (2 419)
Opening		2' 7 1/2"	3' 1 1/2"	4' 1 1/2"	5' 0"	6' 0"	8' 0"
Frame		2' 6 3/4"	3' 0 3/4"	4' 0 3/4"	4' 11 1/4"	5' 11 1/4"	7' 11 1/4"
(654) (635)	2' 1 3/4"						
	1' 5"						
	2' 1"						
(375) (356)	1' 2"						
(451) (432)	1' 5 3/4"						
(654) (635)	2' 1 3/4"						

Not to scale.



Pella® Reserve™ Traditional Sliding Patio Door

Special Sizes and Dimensions

Special Sizes

	Minimum	Maximum	Sizing Increments
OX, XO	4' 11-1/4" W x 6' 2" H (59-1/4" x 74") (1 505 x 1 880)	9' 11-1/4" W x 9' 11-1/2" H (119-1/4" x 119-1/2") (3 029 x 3 035)	Nearest 1/4"
OXO	7' 6-1/4" W x 6' 2" H (90-1/4" x 74") (2 292 x 1 880)	15' 1/4" W x 9' 11-1/2" H (180-1/4" x 119-1/2") (4 578 x 3 035)	Nearest 1/4"
OXXO	9' 9-1/4" W x 6' 2" H (117-1/4" x 74") (2 978 x 1 880)	19' 9-1/4" W x 9' 11-1/2" H (237-1/4" x 119-1/2") (6 026 x 3 035)	Nearest 1/4"
Transoms	1' 6" W x 1' 2" H (18" x 14") (457 x 356)	7' 11-1/4" W x 2' 1" H (95-1/4" x 25") (2 419 x 635)	Nearest 1/8"

Knock-down Frames

When the below conditions are met, units will be shipped as knock-down frames.

Door Type	
OX, XO	Optional for sizes ≤ 96", Required for sizes > 96"
OXO	Required - All sizes
OXXO	Required - All sizes

Miscellaneous Formulas

	Width	Height
Visible Glass	Width of OX, XO = $(FW - 10.5) \div 2 - 1.25$ Width of OXO = $(FW - 17.125) \div 3 - 1.25$ Width of OXXO = $(FW - 19.75) \div 4 - 1.25$	Height = $FH - 8.75$ "
Actual Glass	Width of OX, XO = $(FW - 10.5) \div 2$ Width of OXO = $(FW - 17.125) \div 3$ Width of OXXO = $(FW - 19.75) \div 4$	Height = $FH - 7.5$ "
Clear Opening Standard Handles	Width of OX, XO = $(FW \div 2) - 7.625$ Width of OXO = $(FW \div 3) - 8.33333$ Width of OXXO = $(FW \div 4) - 7.5$	Height = $FH - 3.5$ "
Clear Opening Optional Handles	Width of OX, XO = $(FW \div 2) - 9.125$ Width of OXO = $(FW \div 3) - 9.83333$ Width of OXXO = $(FW \div 4) - 9$	Height = $FH - 3.5$ "

	Transoms	
	Visible Glass	Actual Glass
Fixed Frame Direct Set	Width = Frame - 3-1/4" Height = Frame - 3-1/4"	Width = Frame - 2" Height = Frame - 2"
Fixed Casement	Width = Frame - 5-3/4" Height = Frame - 5-3/4"	Width = Frame - 4-3/8" Height = Frame - 4-3/8"
Wide Stile Casement	Width = Frame - 11-5/8" Height = Frame - 5-3/4"	Width = Frame - 10-1/4" Height = Frame - 4-3/8"

(1) Available within size range shown.

To convert areas to square meters (m²), multiply square feet by 0.0929.

Fixed-Vent-Fixed (OXO) vent to the right only.



Pella® Reserve™ Traditional Sliding Patio Door

Design Data

Sliding Door Design Data								
	Unit	Venting	Clear Opening		Vent Area Ft ²	Visible Glass Ft ²	Standard Glass Thickness (mm) Tempered	Performance Class & Grade ₁
			Width (Inches)	Height (Inches)				
6' 7-1/2" Doors	6080	OX, XO	22	76	11.6	22.7	3	LC50
	7280	OX, XO	28	76	14.8	28.6	3	LC50
	8480	OX, XO	34	76	17.9	34.5	3	LC35/LC50
	9680	OX, XO	40	76	21.1	40.4	4	LC35/LC50
	12080	OX, XO	52	76	27.4	52.2	4	R20/LC30
	9080	O XO	21-3/4	76	11.5	34.1	3	LC35
	10880	O XO	27-3/4	76	14.6	42.9	3	LC35
	12680	O XO	33-3/4	76	17.8	51.8	3	LC35
	14480	O XO	39-3/4	76	21.0	60.6	4	LC35
	18080	O XO	51-3/4	76	27.3	78.3	4	R20
	11780	O X XO	43-5/8	76	23.0	45.4	3	LC35
	14180	O X XO	55-5/8	76	29.4	57.2	3	LC35
	16580	O X XO	67-5/8	76	35.7	69.0	3	LC35
	18980	O X XO	79-5/8	76	35.7	69.0	4	LC35
	23780	O X XO	103-5/8	76	42.0	80.8	4	R20
6' 10" Doors	6082	OX, XO	22	78	11.9	23.4	3	LC50
	7282	OX, XO	28	78	15.2	29.4	3	LC50
	8482	OX, XO	34	78	18.4	35.5	3	LC35/LC50
	9682	OX, XO	40	78	21.7	41.6	4	LC35/LC50
	12082	OX, XO	52	78	28.2	53.7	5	R20/LC30
	9082	O XO	21-3/4	78	11.8	35.0	3	LC35
	10882	O XO	27-3/4	78	15.0	44.1	3	LC35
	12682	O XO	33-3/4	78	18.3	53.2	3	LC35
	14482	O XO	39-3/4	78	21.5	62.3	4	LC35
	18082	O XO	51-3/4	78	28.0	80.5	5	R20
	11782	O X XO	43-5/8	78	23.6	46.7	3	LC35
	14182	O X XO	55-5/8	78	30.1	58.9	3	LC35
	16582	O X XO	67-5/8	78	36.6	71.0	3	LC35
	18982	O X XO	79-5/8	78	43.1	83.1	4	LC35
	23782	O X XO	103-5/8	78	56.1	107.4	5	R20

Continued on the next page.

(-) = Not Applicable

(1) Maximum performance when glazed with the appropriate glass thickness. Second performance class and grade (where shown) requires performance upgrade and appropriate installation methods.

All doors are glazed with tempered glass.

Fixed-Vent-Fixed (OXO) vent to the right only.

Clear opening width shown is with standard hardware.

To convert areas to square meters (m²), multiply square feet by 0.0929.



Pella® Reserve™ Traditional Sliding Patio Door

Design Data

Sliding Door Design Data								
	Unit	Venting	Clear Opening		Vent Area Ft ²	Visible Glass Ft ²	Standard Glass Thickness (mm) Tempered	Performance Class & Grade ₁
			Width (Inches)	Height (Inches)				
8' 0" Doors	6096	OX, XO	22	92	14.1	27.9	4	LC35/LC50
	7296	OX, XO	28	92	17.9	35.1	4	LC35/LC50
	8496	OX, XO	34	92	21.7	42.3	4	LC35/LC50
	9696	OX, XO	40	92	25.6	49.5	4	LC35/LC50
	12096	OX, XO	52	92	33.2	64.0	5	R20/LC30
	9096	O XO	21-3/4	92	13.9	41.8	4	LC35
	10896	O XO	27-3/4	92	17.7	52.6	4	LC35
	12696	O XO	33-3/4	92	21.6	63.5	4	LC35
	14496	O XO	39-3/4	92	25.4	74.3	4	LC35
	18096	O XO	51-3/4	92	33.1	96.0	5	LC20
	11796	O X XO	43-5/8	92	27.9	55.7	4	LC35
	14196	O X XO	55-5/8	92	35.5	70.2	4	LC35
	16596	O X XO	67-5/8	92	43.2	84.6	4	LC35
	18996	O X XO	79-5/8	92	50.9	99.1	4	LC35
	23796	O X XO	103-5/8	92	66.2	128.0	5	R20
9' 0" Doors	60108	OX, XO	22	104	15.9	31.7	3	R20/LC30
	72108	OX, XO	28	104	20.2	39.9	3	R20/LC30
	84108	OX, XO	34	104	24.6	48.2	4	R20/LC30
	96108	OX, XO	40	104	28.9	56.4	4	R20/LC30
	120108	OX, XO	52	104	37.6	72.9	6	R20/LC30
	90108	O XO	21-3/4	104	15.7	47.6	3	R20
	108108	O XO	27-3/4	104	20.0	59.9	3	R20
	126108	O XO	33-3/4	104	24.4	72.3	4	R20
	144108	O XO	39-3/4	104	28.7	84.6	4	R20
	180108	O XO	51-3/4	104	37.4	109.3	6	R20
	117108	O X XO	43-5/8	104	31.5	63.4	3	R20
	141108	O X XO	55-5/8	104	40.2	79.9	3	R20
	165108	O X XO	67-5/8	104	48.8	96.3	3	R20
	189108	O X XO	79-5/8	104	57.5	112.8	4	R20
	237108	O X XO	103-5/8	104	74.8	145.7	6	R20
10' 0" Doors	60120	OX, XO	22	116	17.7	35.6	3	R20/LC30
	72120	OX, XO	28	116	22.6	44.8	3	R20/LC30
	84120	OX, XO	34	116	27.4	54.0	4	R20/LC30
	96120	OX, XO	40	116	32.2	63.3	4	R20/LC30
	120120	OX, XO	52	116	41.9	81.7	6	R20/LC30
	90120	O XO	21-3/4	116	17.5	53.4	3	R20
	108120	O XO	27-3/4	116	22.4	67.2	3	R20
	126120	O XO	33-3/4	116	27.2	81.0	4	R20
	144120	O XO	39-3/4	116	32.0	94.9	4	R20
	180120	O XO	51-3/4	116	41.7	122.6	6	R20
	117120	O X XO	43-5/8	116	35.1	71.1	3	R20
	141120	O X XO	55-5/8	116	44.8	89.6	3	R20
	165120	O X XO	67-5/8	116	54.5	108.1	3	R20
	189120	O X XO	79-5/8	116	64.1	126.5	4	R20
	237120	O X XO	103-5/8	116	83.5	163.4	6	R20

Transoms						
Unit	Visible Glass Ft ²	Standard Glass Thickness (mm)		Performance Class & Grade ₁		
		Annealed	Tempered			
Fixed Frame Direct Set	3117	2.6	3	3	CW90	
	3125	4.2	3	3	CW90	
	3717	3.2	3	3	CW90	
	3725	5.1	3	3	CW90	
	4917	4.3	3	3	CW90	
	4925	6.9	3	3	CW75	
	6017	5.3	3	3	CW90	
	6025	8.5	3	3	CW55	
	7217	6.5	3	3	CW60	
	7225	10.3	3	3	CW45	
	9617	8.8	—	4	CW60	
	9625	13.9	4	4	CW60	
	Fixed Casement	3117	2.0	3	3	CW50
		3125	3.3	3	3	CW50
		3717	2.4	3	3	CW50
3725		4.1	3	3	CW50	
4917		3.4	3	3	CW50	
4925		5.7	3	3	CW50	
6017		4.2	3	3	CW50	
6025		7.2	3	3	CW45/CW50	
7217		5.1	—	3	R15 ₂	
7225		8.8	3	3	R15 ₂	
9617		7.0	—	4	R15 ₂	
9625		12.0	4	4	R15 ₂	
Wide Stile Casement		3117	1.4	3	3	CW50
		3125	2.4	3	3	CW50
		3717	1.9	3	3	CW50
	3725	3.2	3	3	CW50	
	4917	2.8	3	3	CW50	
	4925	4.8	3	3	CW50	
	6017	3.6	3	3	CW50	
	6025	6.2	3	3	CW50	
	7217	4.6	3	3	CW50	
	7225	7.8	3	3	R15 ₂	
	9617	6.4	—	4	R15 ₂	
	9625	11.0	4	4	R15 ₂	

(—) = Not Applicable

(1) Maximum performance when glazed with the appropriate glass thickness. Second performance class and grade (where shown) requires performance upgrade and appropriate installation methods.

All doors are glazed with tempered glass.

Fixed-Vent-Fixed (OXO) vent to the right only.

(2) Units with a Performance Class and Grade of R15, are not AAMA/WDMA performance certified. Units are engineered to meet the performance class and grade shown.

Clear opening width shown is with standard hardware.

To convert areas to square meters (m²), multiply square feet by 0.0929.



Pella® Reserve™ Traditional Sliding Patio Door

Detailed Product Description - Aluminum-Clad Exterior

Frame

- Head and jambs are aluminum with fiberglass thermal breaks.
- Low-profile solid fiberglass sill with Black finish.
- Interior trim and jamb covers are pine edge banded and veneered and finished to match panel interiors.
- Exterior surfaces are aluminum at the head and jambs.
- Components are assembled with screws and corner locks.
- Optional factory-installed fold-out installation fins with flexible fin corners.
- Fin position will accommodate standard 4-9/16" (116 mm) wall depths.
- Frame depth is 5-7/8" (149 mm).
- Optional supplied jamb extensions available between 4-9/16" (116 mm) and 7-3/16" (183 mm) wall depths.
- Optional factory-applied EnduraClad® exterior trim.

Door panels

- Select softwood, immersion treated with Pella's EnduraGuard® wood protection formula in accordance with WDMA I.S.-4. The EnduraGuard formula includes three active ingredients for protection against the effects of moisture, decay and stains from mold and mildew. Plus, an additional ingredient adds protection against termite damage.
- Interior exposed surfaces are veneered with pine.
- Exterior surfaces are clad with aluminum.
- Panel stiles have LVL core and veneered on interior face.
- Panel rails are constructed with randomly finger-jointed blocks laminated with water-resistant glue and veneered on interior face.
- Corners are secured with metal fasteners and structural adhesive.
- Panel thickness is 2-1/16" (52 mm).
- Vent panels have two adjustable ABEC 5 sealed electroplated steel ball-bearing rollers with organic coating, set on stainless steel track, standard.
 - or -
- Two adjustable corrosion-resistant stainless steel ball-bearing rollers; out-of-unit option.

Weatherstripping

- Flexible polymeric leaf section with overlapped corners and a slip-coating at head and jamb.
- Dual-durometer extruded polymer with bulb at sill and interlocker.

Glazing System ¹

- Quality fully-tempered float glass complying with ASTM C 1048.
- Custom and high altitude glazing available.
- Silicone-glazed, 3/4" double-pane, dual-seal, insulating glass
 - [Clear] [Obscure] with air.
 - [Obscure Low-E with [argon][air]] [Advanced Low-E] [Advanced Comfort Low-E] [SunDefense™ Low-E] [NaturalSun Low-E] with [argon] [air].
 - [Bronze] [Gray] [Green] Advanced Low-E with [argon] [air].
 - or -
- Silicone-glazed, [3/4"] [7/8"] double-pane, dual-seal, laminated, insulating glass
 - Clear with air.
 - [Advanced Low-E] [SunDefense™ Low-E] with argon.
 - [Bronze] [Gray] [Green] Advanced Low-E with argon.
 - or -
- Silicone-glazed, 1-3/8" triple-pane, dual-seal, insulating glass
 - [Obscure Low-E with [argon][air]] [Advanced Low-E] [SunDefense™ Low-E] [NaturalSun Low-E] with [argon] [air].

Exterior

- Aluminum clad exteriors shall be finished with EnduraClad® protective finish, in a multi-step, baked-on finish.
 - Color is [Standard] [Feature] [custom]₂.
 - or -
- Aluminum clad exteriors shall be finished with EnduraClad Plus protective finish with 70% fluoropolymer resin in a multi-step, baked-on finish.
 - Color is [Standard] [Feature] [custom]₂.

Interior

- [Unfinished, ready for site finishing] [factory primed with one coat acrylic latex] [factory prefinished [paint] [stain]₂].

Hardware

- [Standard Exterior handle finish is matched to exterior cladding finish] [Interior and exterior handle finish is [Satin Brass] [Satin Nickel] [Oil-Rubbed Bronze] [Distressed Nickel] [Distressed Bronze] [Polished Chrome] [baked enamel [Champagne] [White] [Brown] [Matte Black]]].
- Keylock with K-keyway cylinder. Finish is [Chrome].
- Multi-point locking hardware is electroplated steel with stainless steel strikes.
- Vent Lock, secondary lock or vents panel open 4", positioned [24" from top for ≤ 96" tall doors] [48" from top for > 96" tall doors] finish is [White] [Black] to correspond with interior panel color.
- Interior and exterior screen handle finish will be [White] [Black] [Brown] [Fossil] [Morning Sky Gray] to complement screen frame color.

Optional Products

Grilles

- Integral Light Technology®
 - Interior grilles are [5/8"] [7/8"] [1-1/4"] [putty] [ogee] profile that are solid pine. Interior surfaces are [unfinished, ready for site finishing] [factory primed] [factory prefinished [White] [Linen White] [Bright White] [stain]₂].
 - Exterior grilles are [5/8" putty profile] [7/8" [putty] [ogee] profile] [1-1/4" [putty] [ogee] profile] that are extruded aluminum.
 - Patterns are [Traditional] [Prairie] [Top Row] [Cross].
 - Insulating glass contains non-glare spacer between the panes of glass.
 - Grilles are adhered to both sides of the insulating glass with VHB acrylic adhesive tape and aligned with spacer
 - or -
- Grilles-Between-the-Glass₃
 - Insulating glass contains 3/4" contoured aluminum grilles permanently installed between two panes of glass.
 - Patterns are [Traditional] [Prairie] [Cross] [Top Row]
 - Interior color is Interior color is [Black] [White] [Brown]₄ [Fossil] [Harvest] [Cordovan] [Ivory] [Tan]₄ [Brickstone] [Putty]₄.
 - Exterior color₅ is [standard] [feature]₂.

Screens

- InView™ screens
 - Vinyl-coated 18/18 mesh fiberglass screen cloth complying with the performance requirements of SMA 1201, set in aluminum frame, supplied complete with all necessary hardware.
 - Insect screen assembly is top-hung on two adjustable nylon rollers installed on exterior side of door panels.
 - Screen frame exterior is painted to match exterior color.
 - or -
- TuffScreen® by Phifer®
 - Vinyl-coated 17/12.5 mesh polyester screen cloth complying with the performance requirements of SMA 1201, set in aluminum frame, supplied complete with all necessary hardware.
 - Insect screen assembly is top-hung on two adjustable nylon rollers installed on exterior side of door panels.
 - Screen frame exterior is painted to match exterior color.

(1) Insulating glass with argon is Low-E coated. All other insulating glass is air-filled.

(2) Contact your local Pella sales representative for current color options.

(3) Available in clear or Low-E insulating glass with argon, and obscure insulated glass.

(4) Tan and Putty Interior GBG colors are available in single-tone (Putty/Putty or Tan/Tan) (Putty mono). Other interior colors are also available with Tan or Brown exterior.

(5) Appearance of exterior grille color will vary depending on Low-E coating on glass.

The TuffScreen and Phifer trademarks are property of Phifer Incorporated.



Pella® Reserve™ Traditional Sliding Patio Door

Glazing Types Overview

GLAZING OPTIONS

3/4" IG PUTTY

7/8" IG PUTTY

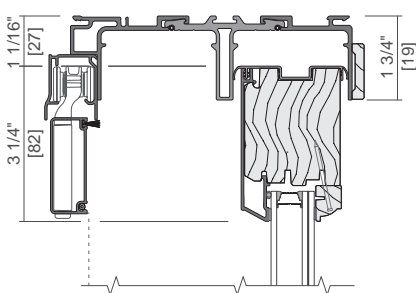
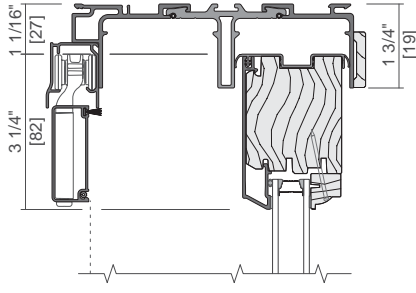

1-3/8" TRIPLE IG

3/4" IG SQUARE

7/8" IG SQUARE

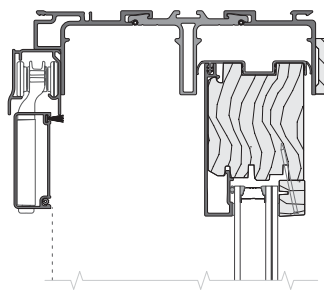
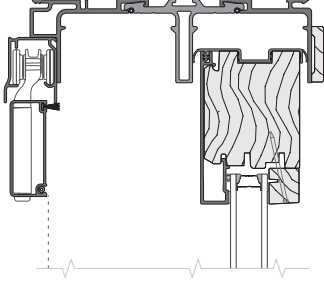
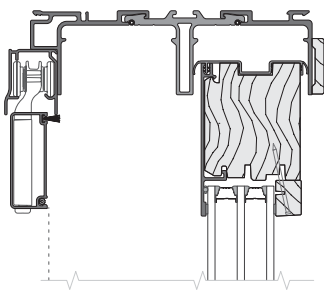

Scale 3" = 1' 0"

All dimensions are approximate.



Pella® Reserve™ Traditional Sliding Patio Door

Unit Sections

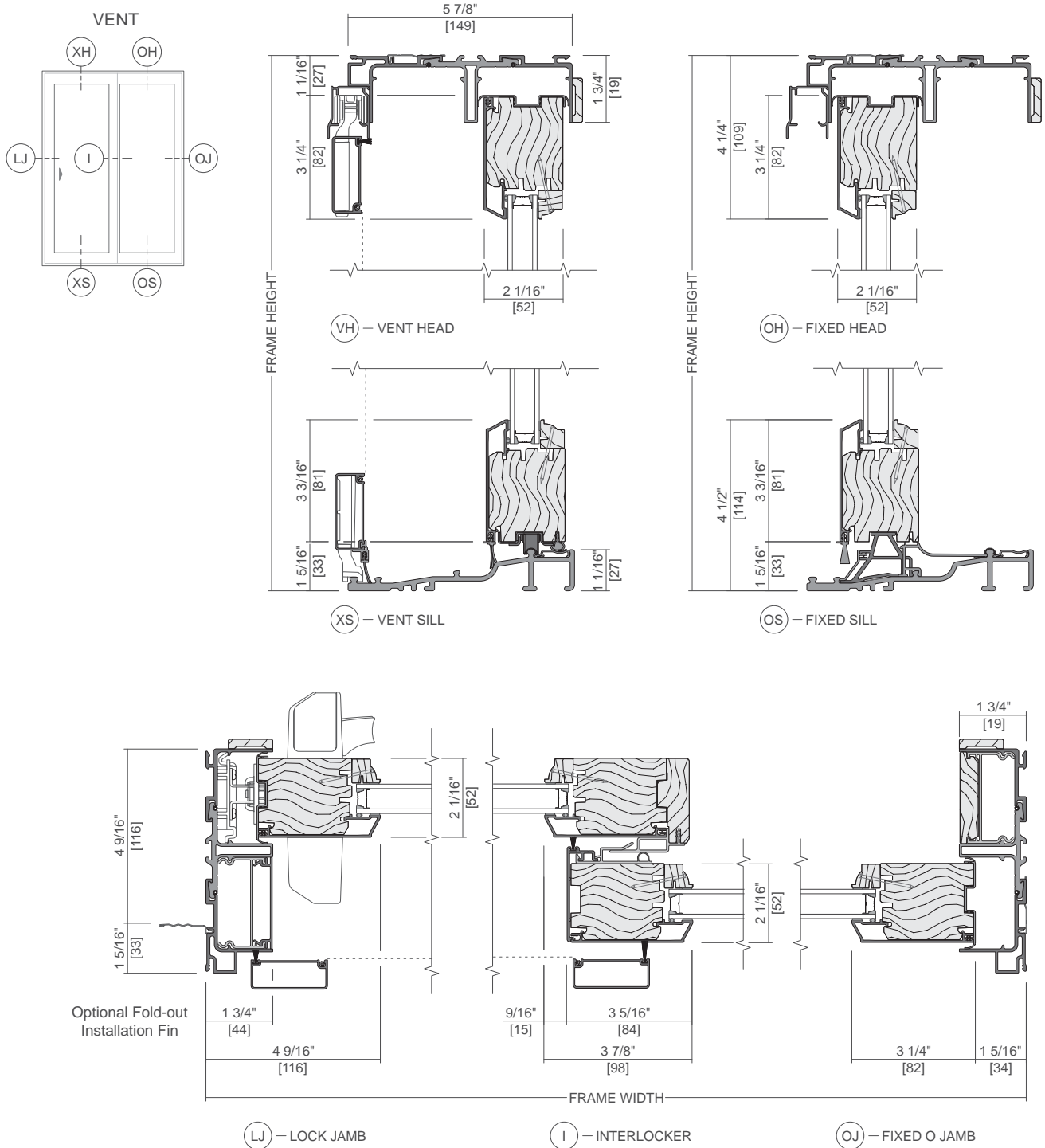

Scale 3" = 1' 0"

All dimensions are approximate.



Pella® Reserve™ Traditional Sliding Patio Door

Unit Sections

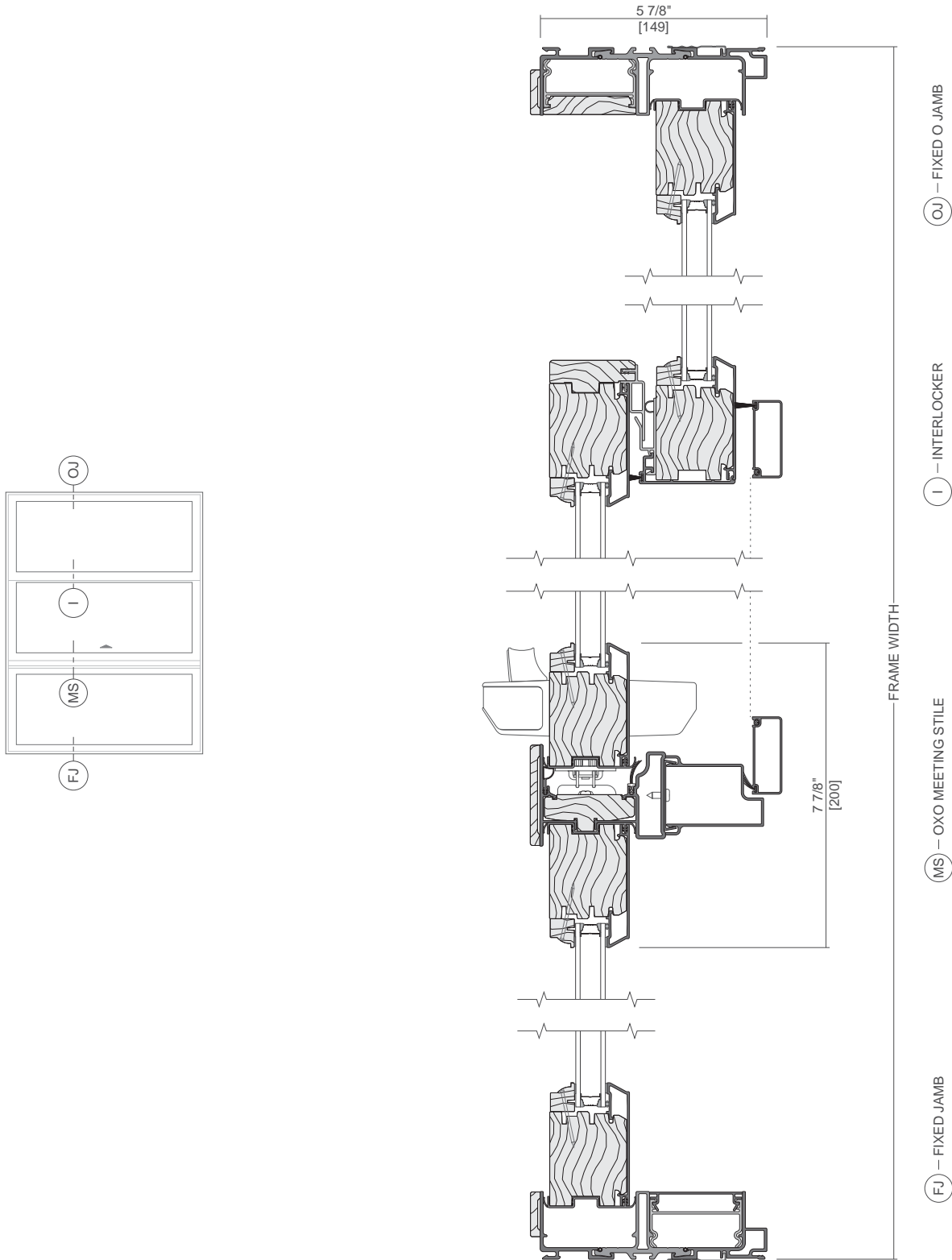

Scale 3" = 1' 0"

All dimensions are approximate.

Rev. 03/21/2025



Pella® Reserve™ Traditional Sliding Patio Door

Unit Sections

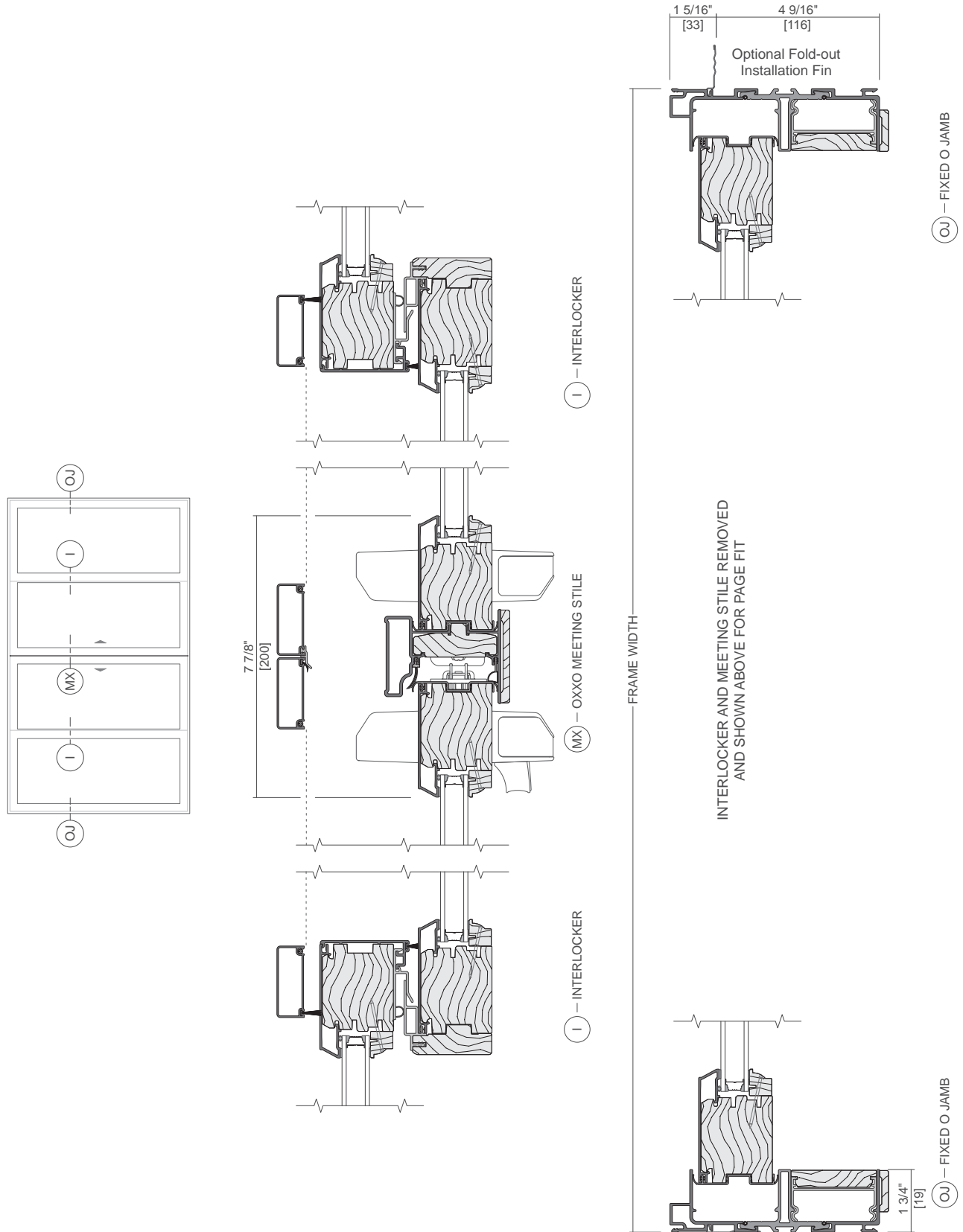

Scale 3" = 1' 0"

All dimensions are approximate.



Pella® Reserve™ Traditional Sliding Patio Door

Unit Sections

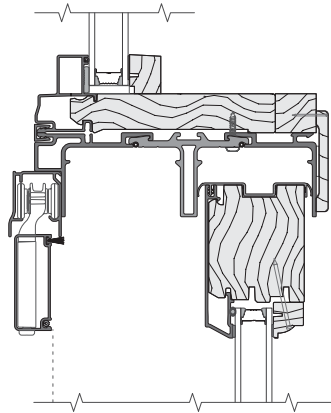
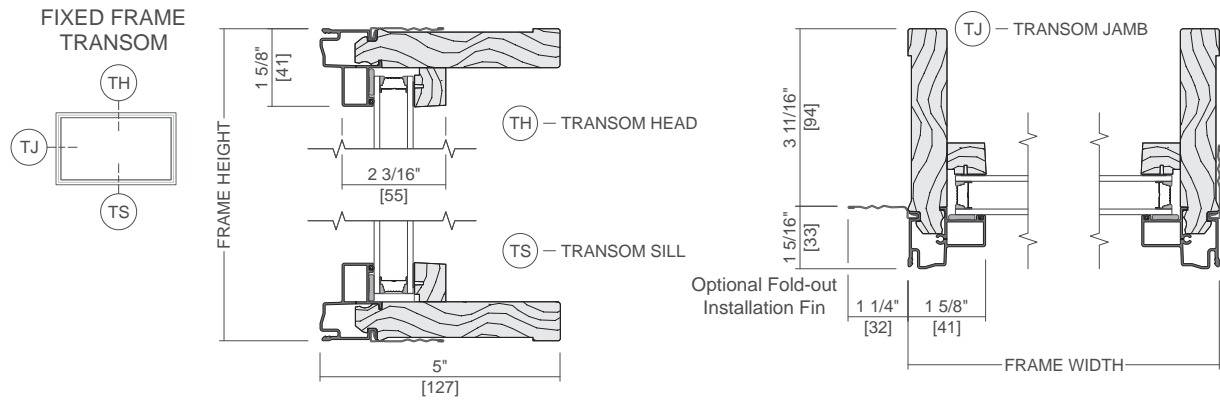

HORIZONTAL JOINING MULLION
TRANSOM / RESERVE SLIDING DOOR (VENT)

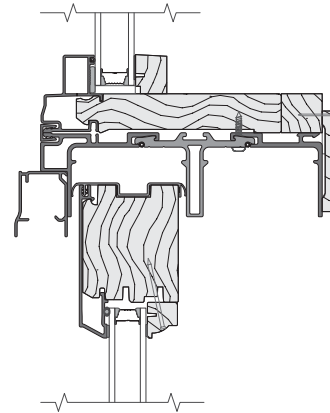

HORIZONTAL JOINING MULLION
TRANSOM / RESERVE SLIDING DOOR (FIXED)

Scale 3" = 1' 0"

All dimensions are approximate.



Pella® Reserve™ Traditional Sliding Patio Door

Unit Sections - Performance Upgrade

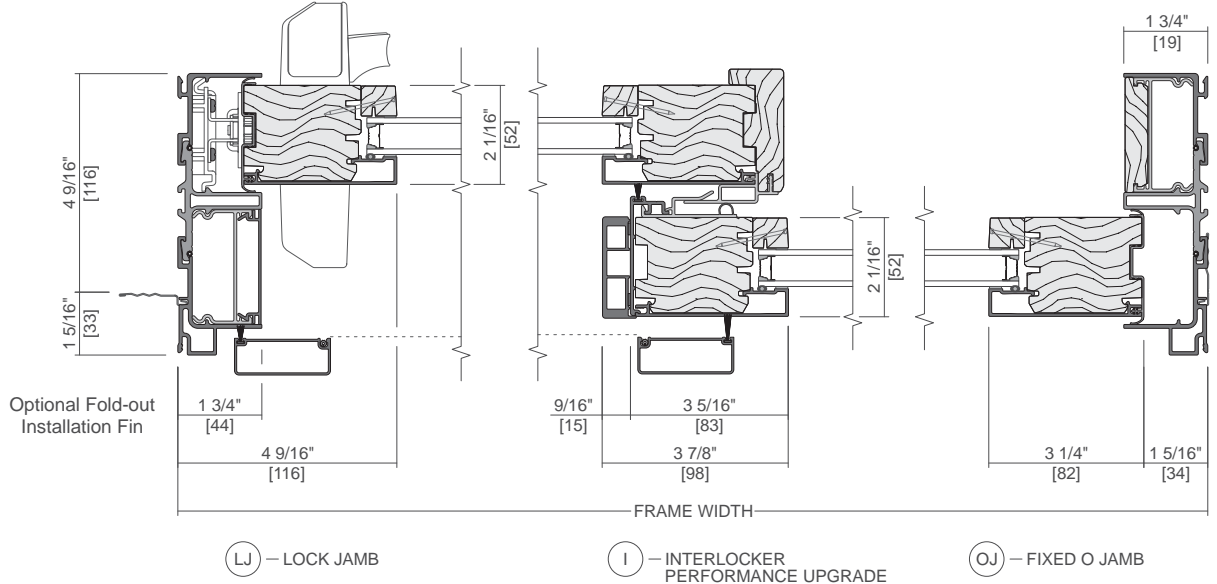
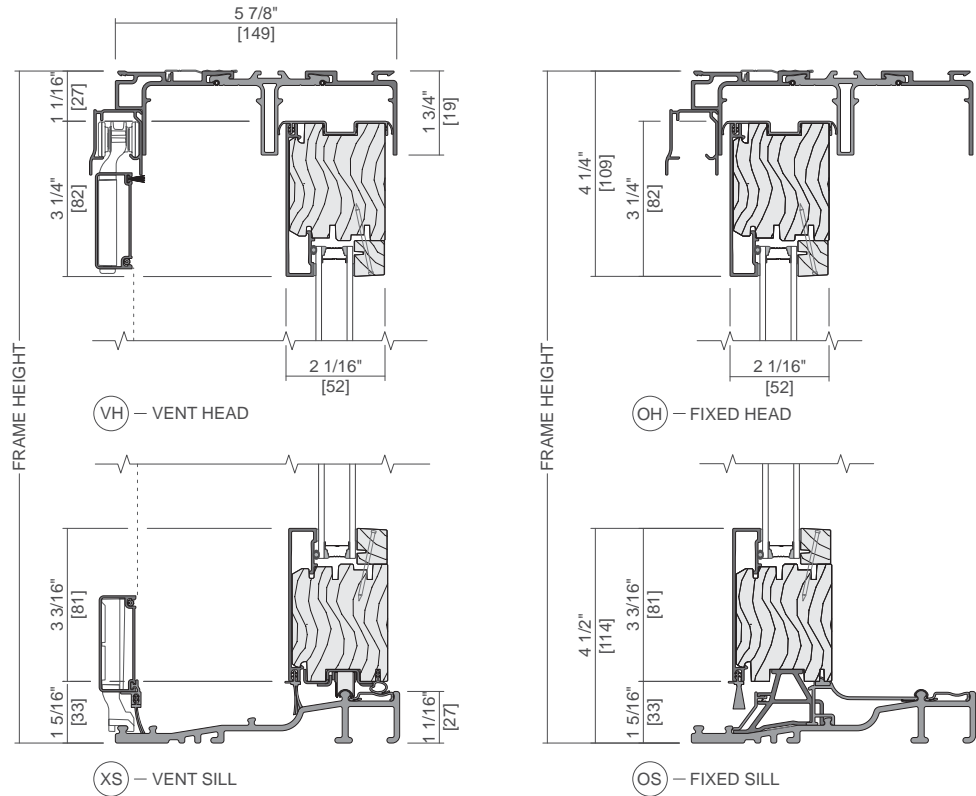
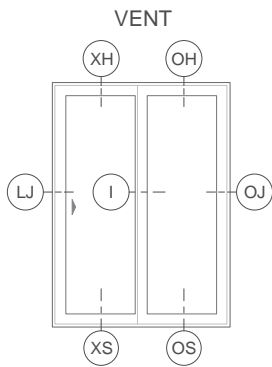

Scale 3" = 1' 0"

All dimensions are approximate.



Pella® Reserve™ Traditional Sliding Patio Door

Unit Sections - Handle Hardware Dimensions

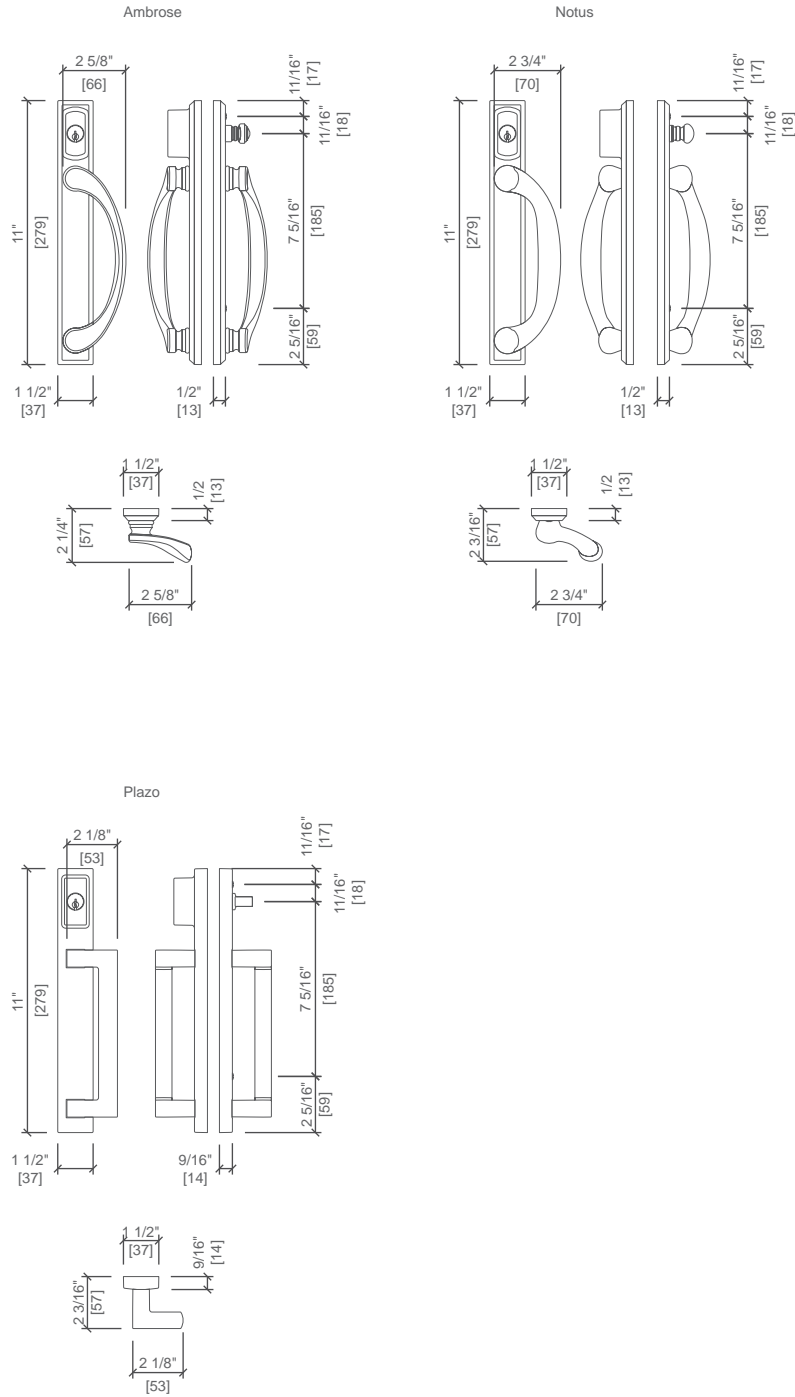

All dimensions are approximate.