



Pella®
Lifestyle
Series



Exceptional performance and solutions for real life

Designed to deliver exceptional performance and create room-by-room solutions with time-tested innovations like Integrated Blinds and Shades.

- Pella® Lifestyle Series is the #1 performing wood window and patio door for the combination of energy efficiency, sound control and value.¹
- Offering everything you love about wood – including beauty, durability and style flexibility and covered by the industry's best limited lifetime warranty for wood windows and patio doors.²
- Pella® Lifestyle Series windows and patio doors with Integrated Blinds and Shades have been recognized by Parents for Window Blind Safety and have been awarded as Best for Kids.
- Certain triple-pane products have been awarded the Quiet Mark Certification in recognition of outstanding acoustic performance making Pella the first U.S. window manufacturer to be awarded this seal.³



Wood Windows
and Patio Doors

1. Performance solutions offering an unbeatable combination of energy efficiency, sound control and value require upgrades to triple-pane, AdvancedComfort Low-E and mixed glass thickness. Based on comparing product quotes and published STC/OITC and U-Factor ratings of leading national wood window and patio door brands.

2. Based on comparing written limited warranties of leading national wood window and wood patio door brands.

3. The Quiet Mark Certification applies to select products only. For a complete list, visit <https://www.quietmark.com/brands/pella-windows-and-doors>.

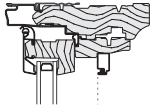
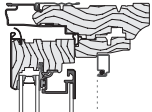
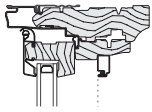
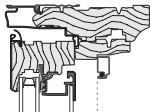
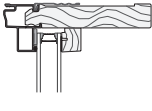
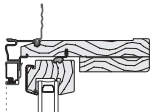
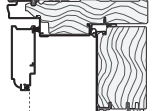
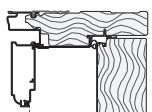
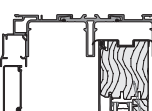
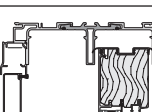
		Cross Section	Frame / Install	Wall Depth Range	Performance Range
Awning Vent and Fixed	Dual-Pane		Standard Fold-out Fin Block Frame	Base Frame Depth: 5" Std. Fin Setback: 1-5/16" Base Wall Depth: 3-11/16" Jamb Extended Wall Depth: 3-11/16" – 9-3/16"	LC30 – LC50 U: 0.25 – 0.34 SHGC: 0.18 – 0.51 STC: up to 32
	Triple-Pane		EnduraClad Exterior Trim / Brickmould	Base Frame Depth: 5" Std. Fin Setback: 1-5/16" Base Wall Depth: 3-11/16" Jamb Extended Wall Depth: 3-11/16" – 9-3/16"	R20 – CW50 U: 0.19 – 0.27 SHGC: 0.15 – 0.42 STC: up to 37
Casement Vent and Fixed	Dual-Pane		Standard Fold-out Fin Block Frame	Base Frame Depth: 5" Std. Fin Setback: 1-5/16" Base Wall Depth: 3-11/16" Jamb Extended Wall Depth: 3-11/16" – 9-3/16"	LC30 – LC50 U: 0.23 – 0.34 SHGC: 0.18 – 0.58 STC: up to 31
	Triple-Pane		EnduraClad Exterior Trim / Brickmould	Base Frame Depth: 5" Std. Fin Setback: 1-5/16" Base Wall Depth: 3-11/16" Jamb Extended Wall Depth: 3-11/16" – 9-3/16"	R20 – LC50 U: 0.18 – 0.28 SHGC: 0.18 – 0.49 STC: up to 37
Fixed Frame Direct Set	Rectangle		Standard Fold-out Fin Block Frame EnduraClad Exterior Trim / Brickmould	Base Frame Depth: 5" Std. Fin Setback: 1-3/16" Base Wall Depth: 3-11/16" Jamb Extended Wall Depth: 3-11/16" – 9-3/16"	F-CW30 – F-AW90 U: 0.17 – 0.48 SHGC: 0.20 – 0.68 STC: up to 38
Double-Hung Vent	Dual-Pane		Standard Fold-out Fin Block Frame EnduraClad Exterior Trim / Brickmould	Base Frame Depth: 5" Std. Fin Setback: 1-5/16" Base Wall Depth: 3-11/16" Jamb Extended Wall Depth: 3-11/16" – 9-3/16"	LC30 – LC50 U: 0.25 – 0.34 SHGC: 0.20 – 0.48 STC: up to 31
In-Swing Patio Door	Dual-Pane		Standard Fold-out Fin Block Frame	Base Frame Depth: 5-7/8" Extended Frame Depth: 5-7/8" - 8-5/8" Std. Fin Setback: 1-5/16" Base Wall Depth: 4-9/16" Extended Wall Depth: 4-9/16" - 7-5/16"	LC50 U: 0.24 – 0.31 SHGC: 0.14 – 0.41 STC: up to 32
	Triple-Pane		EnduraClad Exterior Trim / Brickmould	Base Frame Depth: 5-7/8" Extended Frame Depth: 5-7/8" - 8-5/8" Std. Fin Setback: 1-5/16" Base Wall Depth: 4-9/16" Extended Wall Depth: 4-9/16" - 7-5/16"	LC55 U: 0.23 – 0.28 SHGC: 0.12 – 0.34 STC: up to 35
Sliding Patio Door	Dual-Pane		Standard Fold-out Fin Block Frame	Base Frame Depth: 5-7/8" Std. Fin Setback: 1-5/16" Base Wall Depth: 4-9/16" Jamb Extended Wall Depth: 4-9/16" - 9-3/16"	R20 – LC50 U: – SHGC: – STC: up to 31
	Triple-Pane		EnduraClad Exterior Trim / Brickmould	Base Frame Depth: 5-7/8" Std. Fin Setback: 1-5/16" Base Wall Depth: 4-9/16" Jamb Extended Wall Depth: 4-9/16" - 9-3/16"	LC35 – LC50 U: – SHGC: – STC: up to 34

Performance ranges shown are for single units and do not account for combinations (multiple units mulled together). Drawings are not to scale.

Brand Overview

Window Frame Dimensions

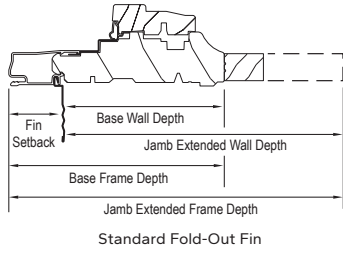

Standard Fold-Out Fin

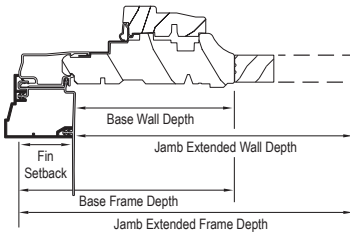

EnduraClad Exterior Trim / Brickmould

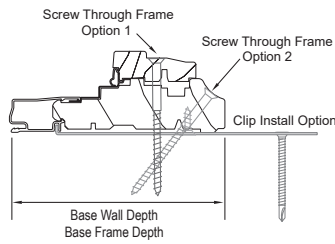

Block Frame / Installation Clip

In-Swing Door Frame Dimensions

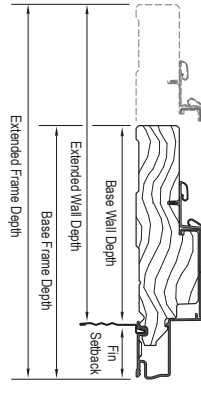

Standard Fold-Out Fin

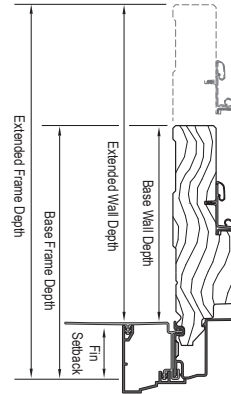

EnduraClad Exterior Trim / Brickmould

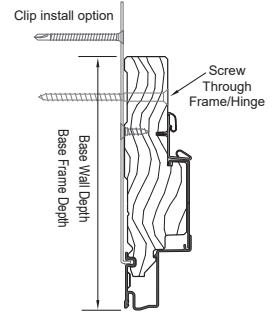

Block Frame / Installation Clip



For installation instructions visit <https://www.pella.com/professionals/installation-instructions/>
Use this Quick-Read (QR) code with your mobile device for quick access.

Internet connection is required.



Rolscreen® Retractable Screens

Optional Rolscreen retractable screen rolls out of sight when you're not using it, so the screen stays protected.

Soft-closing retractable screens are available for casement windows.

WARNING: Screen will not stop child or pet from falling out of window or door. Keep child or pet away from open window or door.

Finishes

EnduraClad® Protective Finish Options: Dual- and Triple-Pane



Interior Prefinished Colors: Dual- and Triple-Pane

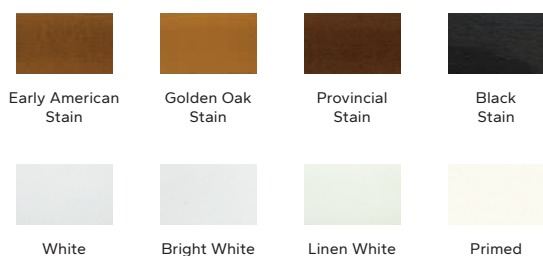

Screens



InView™ Screen

Standard screen on Pella wood windows, as well as Rolscreen® retractable screen on casement windows.

Vinyl coated 18/18 mesh fiberglass. Complies with performance requirements of SMA 1201.

TuffScreen® by Phifer®

The TuffScreen is 2.5x stronger than a standard screen. It is tear, puncture and damage resistant, standing up to pets, children and harsh weather. Now available on Pella wood sliding patio doors.

Vinyl coated 17 x 12.5 mesh Polyester. Complies with performance requirements of SMA 1201.

Because of printing and display limitations, actual colors may vary from those shown.

(1) Based on the composite results of a 5-panel strength analysis comparing Tuffscreen and standard screening. The TuffScreen trademark is property of Phifer Incorporated.

WARNING: Screen will not stop child or pet from falling out of window or door. Keep child or pet away from open window or door.

Brand Overview

Between-the-Glass Options

Pella® Lifestyle Series Between-the-Glass options include *Raise-and-Lower Slimshade Blinds* that raise, lower and tilt and *Fabric Shades* in various levels of transparency, energy efficiency, and sound absorption.

Slimshade Blinds

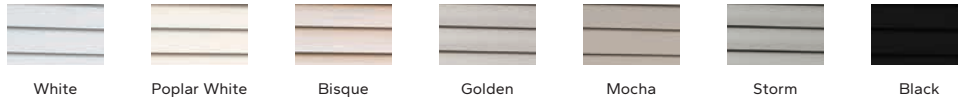

Between-the-Glass Fabric Shades

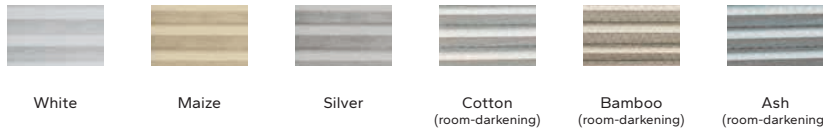

Grilles

For a full list of grille size and pattern availability, contact your local Pella sales representative.

Grilles-Between-the-Glass ¹

- Permanent aluminum grilles are factory-installed inside the airspace of insulating glass
- Black, White, Brown, Fossil, Ivory, Harvest, or Cordovan interior
- Exterior finish is White, Black or matches aluminum-cladding color
- Grilles are 3/4" wide

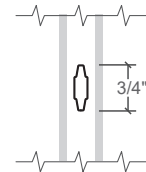

Simulated-Divided-Light Grilles (with optional spacer) (Dual-Pane)

- Permanent aluminum grilles are bonded to the exterior of the glass, wood grilles are bonded to the interior of the glass
- Exterior finish matches aluminum-cladding color
- Grilles are 7/8" wide
- Interior colors match interior finish

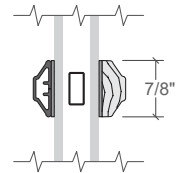

Available Patterns

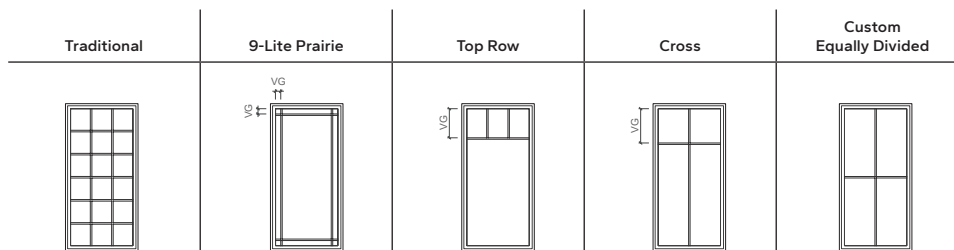

Pattern availability may vary depending on size of unit.
Custom configurations are also available; for details contact your local Pella sales representative.

(1) Appearance of exterior grille color may vary depending on the Low-E insulating glass selection.

Because of printing limitations, actual colors may vary slightly from those shown.

Hardware

Essential Collection



Finishes



Performance Packages

Available performance solutions offer an unbeatable combination of energy efficiency, sound control and value.*

Base	Performance	Sound Control	Energy Efficiency	Ultimate Performance
<p>Low-E</p> <p>EXTERIOR</p> <p>INTERIOR</p>	<p>Low-E 270</p> <p>EXTERIOR</p> <p>INTERIOR</p> <p>clear (HGP)</p> <p>clear</p>	<p>Low-E 270</p> <p>EXTERIOR</p> <p>INTERIOR</p> <p>clear (HGP)</p> <p>clear</p>	<p>Low-E 270</p> <p>EXTERIOR</p> <p>INTERIOR</p> <p>clear (HGP)</p> <p>i89 (Hard Coat)</p>	<p>Low-E 270</p> <p>EXTERIOR</p> <p>INTERIOR</p> <p>clear (HGP)</p> <p>i89 (Hard Coat)</p>
<p>Advanced Low-E AdvancedComfort Low-E SunDefense Low-E NaturalSun Low-E</p> <p>Two panes of insulating, energy-efficient glass and our most popular features and options.</p>	<p>Advanced Low-E SunDefense Low-E or NaturalSun Low-E</p> <p>A triple-pane glass design for a combination of both improved energy efficiency and sound performance.</p>	<p>Advanced Low-E SunDefense Low-E NaturalSun Low-E</p> <p>Triple-pane glass design featuring mixed glass thicknesses for enhanced sound dampening.</p>	<p>AdvancedComfort Low-E SunDefense+ Low-E NaturalSun+ Low-E</p> <p>A triple-pane glass design with upgraded AdvancedComfort Low-E glass for enhanced energy efficiency.</p>	<p>AdvancedComfort Low-E SunDefense+ Low-E NaturalSun+ Low-E Sound-reduction glazing</p> <p>A triple-pane glass design featuring mixed glass thicknesses with upgraded AdvancedComfort Low-E glass for enhanced energy efficiency.</p>

*Performance solutions require upgrades to triple-pane, Low-E and mixed glass thickness. Based on comparing product quotes and published STC/OITC and U-Factor ratings of leading national wood window and patio door brands.

Because of printing limitations, actual colors may vary slightly from those shown.



Pella®
Lifestyle
Series

Awning



Dual-Pane

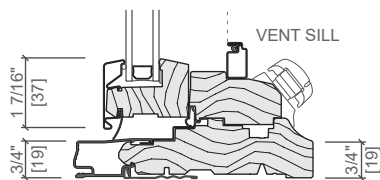
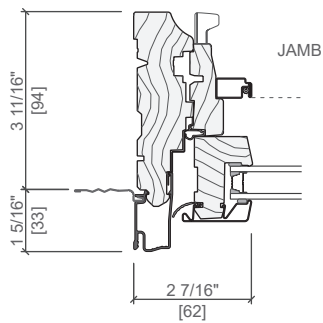
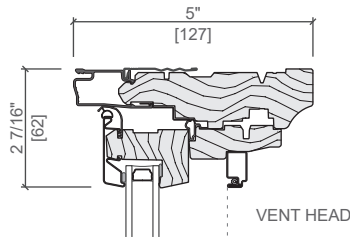

Triple-Pane

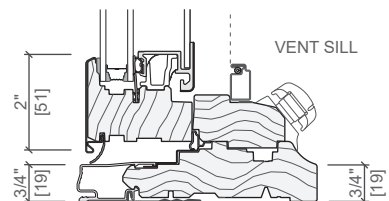
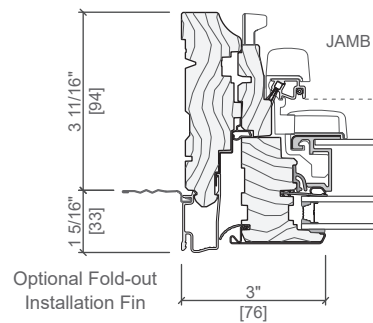
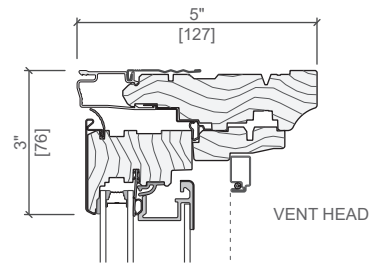

Other frame types are available.

Not to scale. All dimensions are approximate.

Triple-Pane Glazing

Air, Water, & Structural Performance	Performance Class & Grade Rating	Water Penetration Resistance	Air Infiltration	Design Pressure	Forced Entry
	R20 – CW50	7.5 psf	0.05	20 – 50 psf	40

Thermal Performance	Type of Glazing (Argon fill)	U-Factor	SHGC	VLT %	CR	Energy Star® Capable
Vent Units <small>11/16" glass thickness, 2.5mm and 3mm, with clear ML (Triple-Pane)</small>	Advanced Low-E IG	0.24 – 0.26	0.21 – 0.23	0.37 – 0.42	66 – 69	NC, SC, S
	SunDefense™ Low-E IG	0.23 – 0.26	0.16 – 0.17	0.34 – 0.39	67 – 70	NC, SC, S
	SunDefense+ Low-E IG	0.19 – 0.21	0.15 – 0.17	0.34 – 0.38	73 – 76	CA, N, NC, SC, S
	AdvancedComfort Low-E IG	0.19 – 0.21	0.20 – 0.22	0.36 – 0.41	73 – 75	CA, N, NC, SC, S
	NaturalSun Low-E IG	0.24 – 0.26	0.37 – 0.42	0.42 – 0.47	66 – 69	CA, N, NC
	NaturalSun+ LowE IG	0.20 – 0.21	0.34 – 0.38	0.41 – 0.46	73 – 75	CA, N, NC

Sound Performance	Frame Size Tested	Type of Glazing		STC	OITC
	Vent; 59" x 23"	11/16" Overall IG thickness with Hinged-Glass-Panel	5mm/3mm/4mm (ML)	34	32
	Vent, with Shade; 59" x 23"		5mm/3mm/4mm (ML)	35	32
	Vent, with Blind; 59" x 23"		5mm/3mm/4mm (ML)	34	32
	Vent; 59" x 23"		2.5mm/2.5mm/2.5mm (ML)	31	27
	Vent, with Shade; 59" x 23"		2.5mm/2.5mm/2.5mm (ML)	33	28
	Vent, with Blind; 59" x 23"		2.5mm/2.5mm/2.5mm (ML)	32	27
	Fixed; 47" x 59"	11/16" Overall IG thickness with Hinged-Glass-Panel	5mm/3mm/4mm (ML)	35	30
	Fixed, with Shade; 47" x 59"		5mm/3mm/4mm (ML)	37	31
	Fixed, with Blind; 47" x 59"		5mm/3mm/4mm (ML)	35	30
	Fixed; 47" x 59"		3mm/3mm/3mm (ML)	33	27
	Fixed, with Shade; 47" x 59"		3mm/3mm/3mm (ML)	35	29
	Fixed, with Blind; 47" x 59"		3mm/3mm/3mm (ML)	34	27

Code Approvals: Hallmark Certified; FPAS#: Vent=11883, Fixed=11877; TDI#: Vent=WIN-675, Fixed=WIN-619

Dual-Pane Glazing

Air, Water, & Structural Performance	Performance Class & Grade Rating	Water Penetration Resistance	Air Infiltration	Design Pressure	Forced Entry
	LC30 – LC50	4.6 - 14.62 psf	0.05	30 - 50 psf	40

Thermal Performance	Type of Glazing (Argon fill)	U-Factor	SHGC	VLT %	CR	Energy Star® Capable
Vent Units <small>11/16" glass thickness, 2.5mm and 3mm, Dual-Pane</small>	Advanced LowE IG	0.29 – 0.33	0.25 – 0.28	0.46 – 0.51	52 – 57	–
	SunDefense™ Low-E IG	0.28 – 0.32	0.19 – 0.21	0.43 – 0.48	53 – 57	SC, S
	SunDefense+ Low-E IG	0.25 – 0.28	0.18 – 0.20	0.42 – 0.46	41 – 46	NC, SC, S
	AdvancedComfort Low-E IG	0.25 – 0.28	0.25 – 0.27	0.45 – 0.50	40 – 45	NC
	NaturalSun LowE IG	0.30 – 0.34	0.46 – 0.51	0.52 – 0.58	52 – 57	–
	NaturalSun+ LowE IG	0.26 – 0.29	0.42 – 0.47	0.51 – 0.57	40 – 44	CA, N

Sound Performance	Frame Size Tested	Type of Glazing		STC	OITC
	Vent; 59" x 23"	11/16" Overall thickness	2.5mm / 2.5mm glass	25	22
			5mm / 3mm glass	32	28
	Fixed; 47" x 59"	11/16" Overall thickness	3mm / 3mm glass	28	24
			5mm / 3mm glass	30	28

* Sound testing result shown for vent awning is taken from a similarly configured vent casement

Code Approvals: Hallmark Certified; FPAS#: Vent = 20532; Fixed = 20653; TDI#: Vent = WIN-2172; Fixed = WIN-2173

See the Performance section earlier in this manual to learn more about performance standards and ratings.

Performance varies based on actual product attributes.



Standard Sizes – Dual-Pane

Vent and Fixed Units

Opening	(451) (432)	(552) (533)	(603) (584)	(654) (635)	(756) (737)	(832) (813)	(908) (889)	(1 060) (1 041)	(1 213) (1 194)	(1 365) (1 346)	(1 518) (1 499)
Frame	1' 5"	1' 9"	1' 11"	2' 1"	2' 5"	2' 8"	2' 11"	3' 5"	3' 11"	4' 5"	4' 11"
1' 5"											
1' 9"											
1' 11"											
2' 1"											
2' 5"											
2' 8"											
2' 11"											
3' 5"											
3' 11"											
4' 5"											
4' 11"											

Fixed Units

5' 5 3/4"											
5' 11"											
6' 1 3/4"											

Special Sizes – Dual-Pane

Special sizes are available in 1/4" increments.

Frame height cannot exceed frame width on special size dual-pane vent units.

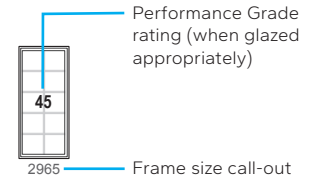
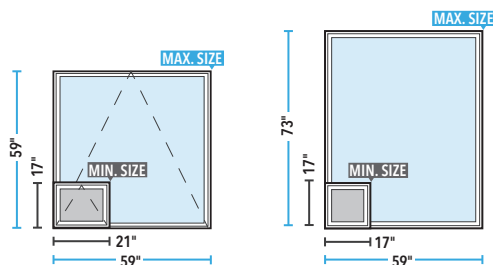

Not to scale.

ⓕ Fixed units only.

ⓧ Tempered required due to aspect ratio.

Standard Sizes – Triple-Pane

Vent and Fixed Units

	(451) (432)	(552) (533)	(603) (584)	(654) (635)	(756) (737)	(832) (813)	(908) (889)	(1 060) (1 041)	(1 213) (1 194)	(1 365) (1 346)	(1 518) (1 499)
Opening	1' 5 3/4"	1' 9 3/4"	1' 11 3/4"	2' 1 3/4"	2' 5 3/4"	2' 8 3/4"	2' 11 3/4"	3' 5 3/4"	3' 11 3/4"	4' 5 3/4"	4' 11 3/4"
Frame	1' 5"	1' 9"	1' 11"	2' 1"	2' 5"	2' 8"	2' 11"	3' 5"	3' 11"	4' 5"	4' 11"
(451) (432)	50	50	50	50	50	50	50	50	50	50	50
(552) (533)	50	50	50	50	50	50	50	45 50	35 50	35 50	30 50
(603) (584)	50	50	50	50	50	50	50	45 50	35 50	30 50	25 50
(654) (635)	50	50	50	50	50	50	50	45 50	35 50	30 50	25 50
(756) (737)	50	50	50	50	50	50	50	45 50	35 50	30 50	25 50
(832) (813)	50	50	50	50	50	50	45 50	40 50	35 50	30 50	25 50
(908) (889)	50	50	50	50	50	45 50	40 50	35 50	30 50	25 50	35 50
(1 060) (1 041)	50	45 50	45 50	45 50	45 50	40 50	35 50	30 50	25 50	35 50	30 50
(1 213) (1 194)	50	35 50	35 50	35 50	35 50	35 50	30 50	25 50	35 50	30 50	25 50
(1 365) (1 346)	50	35 50	30 50	30 50	30 50	30 50	25 50	35 50	30 50	25 50	25 50
(1 518) (1 499)	50	30 50	25 50	25 50	25 50	25 50	35 50	30 50	25 50	25 50	30 50

Fixed Units

(1 670) (1 651)	50	25 50	20 50	20 50	25 50	25 50	25 50	25 50	30 50	25 50	25 50
(1 822) (1 803)	50	25 50	20 50	20 50	25 50	25 50	25 50	25 50	30 50	30 50	25 50
(1 873) (1 854)	50	25 50	20 50	20 50	25 50	25 50	25 50	25 50	30 50	30 50	25 50

Special Sizes – Triple-Pane

Special sizes are available in 1/4" increments.

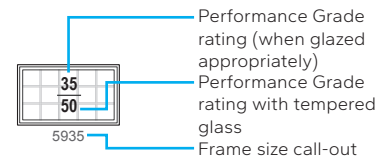
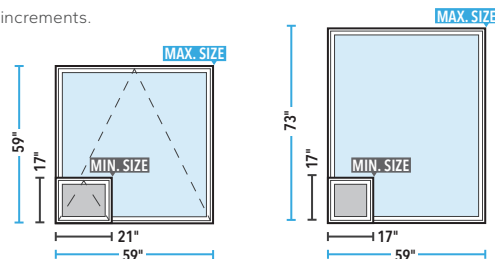

Not to scale.

ⓕ Fixed units only.

ⓓ Tempered required due to aspect ratio.





Pella®
Lifestyle
Series

Casement



Dual-Pane

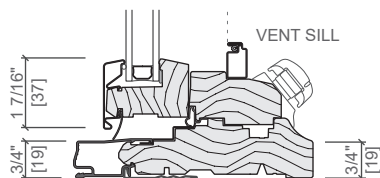
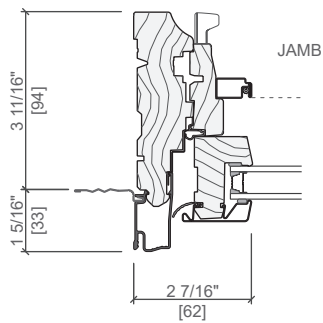
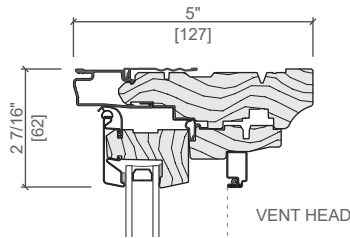

Triple-Pane

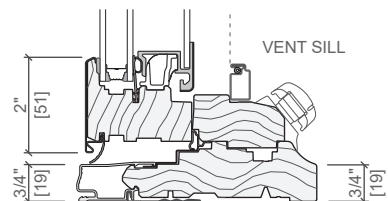
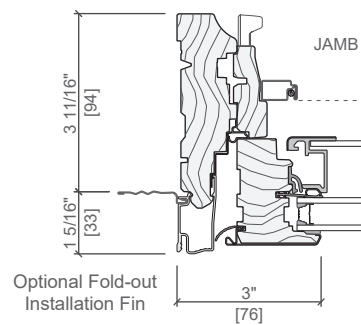
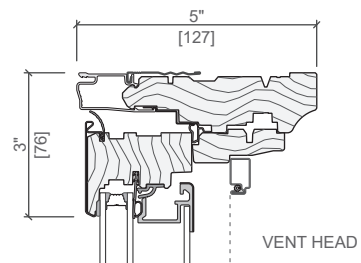

Other frame types are available. Not to scale. All dimensions are approximate.

Triple-Pane Glazing

Air, Water, & Structural Performance	Performance Class & Grade Rating	Water Penetration Resistance	Air Infiltration	Design Pressure	Forced Entry
	R20 – CW50	7.5 psf	.05	20 – 50 psf	40

Thermal Performance	Type of Glazing (Argon fill)	U-Factor	SHGC	VLT %	CR	Energy Star® Capable
Vent Units 11/16" glass thickness, 2.5mm and 3mm, with clear ML (Triple-Pane)	Advanced LowE IG	0.24 – 0.26	0.24 – 0.27	0.44 – 0.50	66 – 69	NC
	SunDefense™ Low-E IG	0.23 – 0.26	0.18 – 0.20	0.41 – 0.46	66 – 69	NC, SC, S
	SunDefense+ Low-E IG	0.19 – 0.21	0.18 – 0.19	0.40 – 0.45	73 – 74	CA, N, NC, SC, S
	AdvancedComfort Low-E IG	0.20 – 0.21	0.20 – 0.26	0.43 – 0.49	74	CA, N, NC, SC, S
	NaturalSun LowE IG	0.24 – 0.26	0.43 – 0.50	0.50 – 0.56	66 – 68	CA, N
	NaturalSun+ LowE IG	0.20 – 0.22	0.39 – 0.45	0.48 – 0.55	73 – 74	CA, N, NC

Sound Performance	Frame Size Tested	Type of Glazing		STC	OITC
	Vent; 23" x 59"	11/16" Overall IG thickness with Hinged-Glass-Panel	2.5mm/2.5mm/2.5mm (ML)	31	25
	Vent; 23" x 59"		5mm/3mm/4mm (ML)	36	31
	Vent, with Shade; 23" x 59"		5mm/3mm/4mm (ML)	37	34
	Vent, with Blind; 23" x 59"		5mm/3mm/4mm (ML)	36	32
	Fixed; 47" x 59"	11/16" Overall IG thickness with Hinged-Glass-Panel	5mm/3mm/4mm (ML)	35	30
	Fixed, with Shade; 47" x 59"		5mm/3mm/4mm (ML)	37	31
	Fixed, with Blind; 47" x 59"		5mm/3mm/4mm (ML)	35	30
	Fixed; 47" x 59"		3mm/3mm/3mm (ML)	33	27
	Fixed; 47" x 59"		4mm/6mm/4mm (ML)	35	29
	Fixed, with Shade; 47" x 59"		4mm/6mm/4mm (ML)	37	31
	Fixed, with Blind; 47" x 59"	4mm/6mm/4mm (ML)	36	30	

Code Approvals: Hallmark Certified; FPAS#: Vent=11865, Fixed=11877; TDI#: Vent=WIN-674, Fixed=WIN-619

Dual-Pane Glazing

Air, Water, & Structural Performance	Performance Class & Grade Rating	Water Penetration Resistance	Air Infiltration	Design Pressure	Forced Entry
	LC30 – LC50	4.59 – 7.52 psf	.05	30 – 50 psf	40

Thermal Performance	Type of Glazing (Argon fill)	U-Factor	SHGC	VLT %	CR	Energy Star® Capable
Vent Units 11/16" glass thickness, 2.5mm and 3mm, Dual-Pane	Advanced LowE IG	0.28 – 0.33	0.25 – 0.28	0.46 – 0.51	54 – 58	–
	SunDefense™ Low-E IG	0.28 – 0.32	0.19 – 0.21	0.43 – 0.48	54 – 59	SC, S
	SunDefense+ Low-E IG	0.25 – 0.28	0.18 – 0.20	0.42 – 0.47	41 – 47	NC, SC, S
	AdvancedComfort Low-E IG	0.25 – 0.28	0.25 – 0.27	0.45 – 0.50	42 – 46	NC
	NaturalSun LowE IG	0.29 – 0.34	0.46 – 0.51	0.52 – 0.58	54 – 58	–
	NaturalSun+ LowE IG	0.25 – 0.29	0.42 – 0.47	0.51 – 0.57	40 – 45	CA, N

Sound Performance	Frame Size Tested	Type of Glazing		STC	OITC
	Vent; 23" x 59"	11/16" Overall thickness	2.5mm / 2.5mm glass	25	22
	Vent; 23" x 59"		5mm / 3mm glass	31	26
	Fixed; 47" x 59"	11/16" Overall thickness	3mm / 3mm glass	28	24
	Fixed; 47" x 59"		5mm / 3mm glass	30	26

Code Approvals: Hallmark Certified; FPAS#: Vent = 20675; Fixed = 20653; TDI#: Vent = WIN-2174; Fixed = WIN-2173

See the Performance section earlier in this manual to learn more about performance standards and ratings.

Performance varies based on actual product attributes.



Standard Sizes – Dual-Pane

Transoms

	(451) (432)	(552) (533)	(603) (584)	(654) (635)	(756) (737)	(832) (813)	(908) (889)
Opening	1' 5 3/4"	1' 9 3/4"	1' 11 3/4"	2' 1 3/4"	2' 5 3/4"	2' 8 3/4"	2' 11 3/4"
Frame	1' 5"	1' 9"	1' 11"	2' 1"	2' 5"	2' 8"	2' 11"
(375) (356)	50 1714	50 2114	50 2314	50 2514	50 2914	50 3214	50 3514
(451) (432)	50 1717	50 2117	50 2317	50 2517	50 2917	50 3217	50 3517
(552) (533)	50 1721	50 2121	50 2321	50 2521	50 2921	50 3221	50 3521
(603) (584)	50 1723	50 2123	50 2323	50 2523	50 2923	50 3223	50 3523
(654) (635)	50 1725	50 2125	50 2325	50 2525	50 2925	50 3225	50 3525
(756) (737)	50 1729	50 2129	50 2329	50 2529	50 2929	50 3229	50 3529

Special Sizes – Dual-Pane

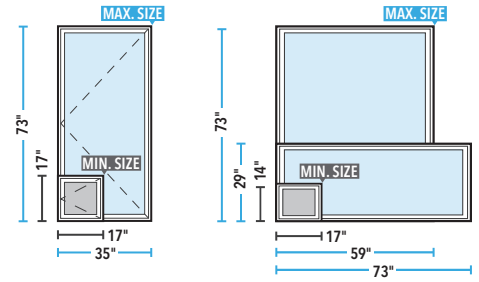

Special sizes are available in 1/4" increments. Frame width cannot exceed frame height on vent special sizes.

Certain aspect ratios may require tempered glass.

Additional standard fixed sizes available up to 59" wide.

Special size 14" tall units are available only up to 59" wide.

When frame width exceeds 59", max frame height is 29".

Vent Units

	(451) (432)	(552) (533)	(603) (584)	(654) (635)	(756) (737)	(832) (813)	(908) (889)
Opening	1' 5 3/4"	1' 9 3/4"	1' 11 3/4"	2' 1 3/4"	2' 5 3/4"	2' 8 3/4"	2' 11 3/4"
Frame	1' 5"	1' 9"	1' 11"	2' 1"	2' 5"	2' 8"	2' 11"
(832) (813)	50 1732	50 2132	50 2332	50 2532	50 2932	50 3232	50 3532
(908) (889)	50 1735	50 2135	50 2335	50 2535	50 2935	50 3235	50 3535
(1060) (1041)	50 1741	50 2141	50 2341	50 2541	50 2941	50 3241	50 3541
(1213) (1194)	50 1747	50 2147	50 2347	50 2547	50 2947	50 3247	50 3547
(1365) (1346)	50 1753	50 2153	50 2353	50 2553	50 2953	50 3253	50 3553
(1518) (1499)	50 1759	45 2159	45 2359	45 2559	45 2959	45 3259	50 3559
(1670) (1651)	50 1765	45 2165	40 2365	40 2565	30 2965	30 3265	30 3565
(1822) (1803)	50 1771	40 2171	35 2371	35 2571	30 2971	30 3271	30 3571
(1873) (1854)	50 1773	40 2173	35 2373	30 2573	30 2973	30 3273	30 3573

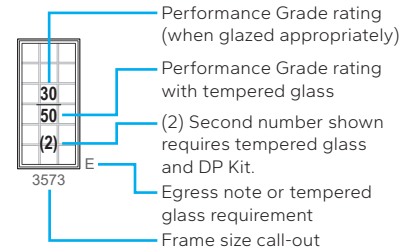

(2) Second number shown requires tempered glass and DP Kit.

ⓕ Fixed units only.

Ⓥ Fixed units typical, vent units available.

Ⓣ Tempered glass is required due to aspect ratio.

Egress Notes (IRC standard):

E = Window meets minimum clear opening of 24" height, 20" width, and 5.7 sq. ft.

E1 = Window meets minimum clear opening of 24" height, 20" width, and 5.0 sq. ft.

E2 = With optional side pivot hardware, window meets minimum clear opening of 24" height, 20" width, and 5.7 sq. ft.

E3 = With optional side pivot hardware, window meets minimum clear opening of 24" height, 20" width, and 5.0 sq. ft.

Check all applicable local codes for emergency egress requirements.

See online Design Data page for Uniform Dwelling Code (UDC) information.

Standard Sizes – Triple-Pane

Transoms

	(451) (432)	(552) (533)	(603) (584)	(654) (635)	(756) (737)	(832) (813)	(908) (889)
Opening	1' 5 3/4"	1' 9 3/4"	1' 11 3/4"	2' 1 3/4"	2' 5 3/4"	2' 8 3/4"	2' 11 3/4"
Frame	1' 5"	1' 9"	1' 11"	2' 1"	2' 5"	2' 8"	2' 11"
1' 5"	50 1717	50 2117	50 2317	50 2517	50 2917	50 3217	50 3517
1' 9"	50 1721	50 2121	50 2321	50 2521	50 2921	50 3221	50 3521
1' 11"	50 1723	50 2123	50 2323	50 2523	50 2923	50 3223	50 3523
2' 1"	50 1725	50 2125	50 2325	50 2525	50 2925	50 3225	50 3525
2' 5"	50 1729	50 2129	50 2329	50 2529	50 2929	50 3229	50 3529

Special Sizes – Triple-Pane

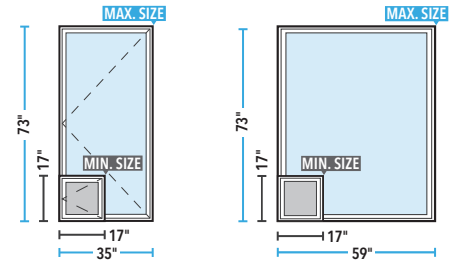

Special sizes are available in 1/4" increments. Frame width cannot exceed frame height on vent special sizes. Certain aspect ratios may require tempered glass.

Vent Units

	(451) (432)	(552) (533)	(603) (584)	(654) (635)	(756) (737)	(832) (813)	(908) (889)
Opening	1' 5 3/4"	1' 9 3/4"	1' 11 3/4"	2' 1 3/4"	2' 5 3/4"	2' 8 3/4"	2' 11 3/4"
Frame	1' 5"	1' 9"	1' 11"	2' 1"	2' 5"	2' 8"	2' 11"
2' 8"	50 1732	50 2132	50 2332	50 2532	50 2932	50 3232	45 50 3532
2' 11"	50 1735	50 2135	50 2335	50 2535	50 2935	45 50 3235	40 50 3535
3' 5"	50 1741	45 50 2141	45 50 2341	45 50 2541	45 50 2941	40 50 3241	35 50 3541
3' 11"	50 1747	35 50 2147	35 50 2347	35 50 2547	35 50 2947	35 50 3247	30 50 3547
4' 5"	50 1753	35 50 2153	30 50 2353	30 50 2553	30 50 2953	30 50 3253	25 50 3553
4' 11"	50 1759	30 50 2159	25 50 2359	25 50 2559	25 50 2959	25 50 3259	35 50 3559
5' 5"	50 1765	25 50 2165	25 50 2365	20 50 2565	20 50 2965	30 50 3265	30 50 3565
5' 11"	50 1771	25 50 2171	20 50 2371	20 50 2571	25 50 2971	25 50 3271	25 50 3571
6' 1"	50 1773	25 50 2173	20 50 2373	20 50 2573	25 50 2973	25 50 3273	25 50 3573

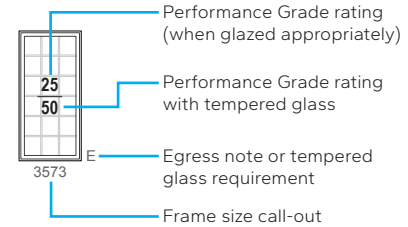

ⓕ Fixed units only.

Ⓥ Vent units available

Ⓣ Tempered glass is standard.

Egress Notes (IRC standard):

- E = Window meets minimum clear opening of 24" height, 20" width, and 5.7 sq. ft.
- E1 = Window meets minimum clear opening of 24" height, 20" width, and 5.0 sq. ft.
- E2 = With optional side pivot hardware, window meets minimum clear opening of 24" height, 20" width, and 5.7 sq. ft.
- E3 = With optional side pivot hardware, window meets minimum clear opening of 24" height, 20" width, and 5.0 sq. ft.

Check all applicable local codes for emergency egress requirements.

Clear opening (egress) information does not take into consideration the addition of a Rolscreen (or any other accessory) to the product.

Consult your local building code to ensure products with Rolcreens meet egress requirements.





Pella®
Lifestyle
Series

Fixed
Frame
Direct Set



Sizes are available in 1/8" increments.

Fixed Interior Glazed

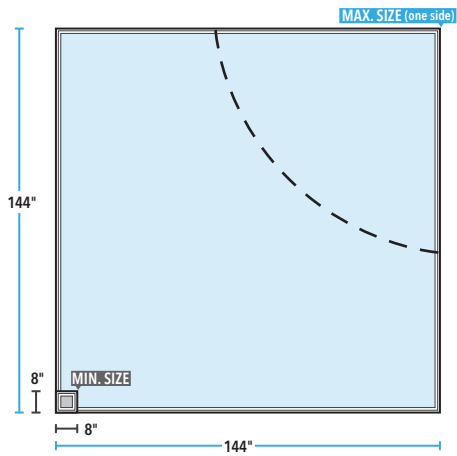

Interior Glazed Fixed Frames are available up to a maximum glass area of 76 sq. ft. (7.06 m²). Not all sizes are certified.

Impact Resistant Glazing is limited to a maximum frame area of 50 sq. ft.

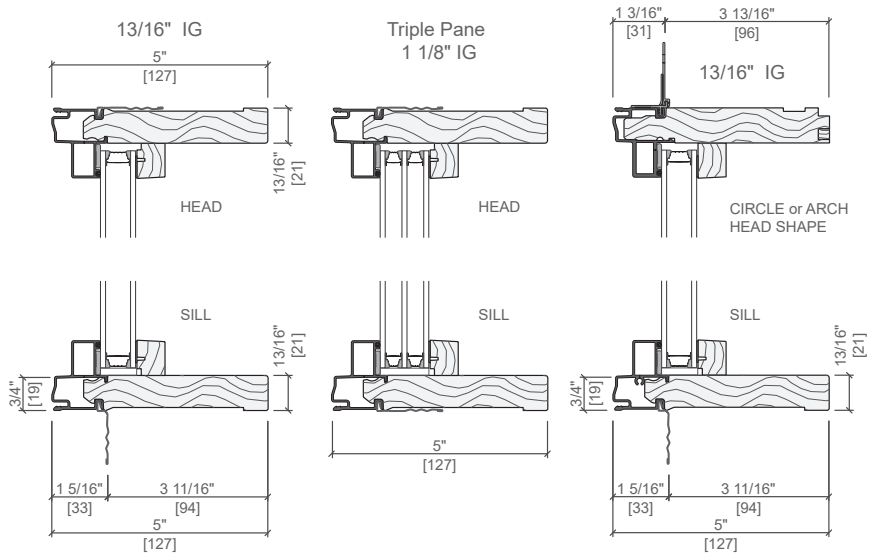

Other frame types are available.

Not to scale. All dimensions are approximate.

Sizes & Performance – Interior Glazed

Air, Water, & Structural Performance	Performance Class & Grade Rating	Water Penetration Resistance	Air Infiltration	Design Pressure	Forced Entry
	F-CW30 – F-CW90	14.62 psf	0.05	30 – 90 psf	–

Thermal Performance	Type of Glazing (Argon fill)	U-Factor	SHGC	VLT %	CR	Energy Star® Capable
	Fixed Units Dual Pane: 13/16" glass thickness, 3mm, Dual-Pane	Advanced LowE IG	0.28 – 0.33	0.29 – 0.33	0.55 – 0.62	54 – 57
SunDefense™ Low-E IG		0.28 – 0.32	0.22 – 0.24	0.51 – 0.57	54 – 57	SC, S
SunDefense+ Low-E IG		0.23 – 0.32	0.21 – 0.24	0.50 – 0.57	46 – 54	NC, SC, S
AdvancedComfort Low-E IG		0.23 – 0.27	0.29 – 0.32	0.54 – 0.60	42 – 45	NC
NaturalSun Low-E IG		0.29 – 0.34	0.55 – 0.61	0.63 – 0.70	53 – 57	CA
Triple Pane: 1-1/8" glass thickness, 3mm	NaturalSun+ Low-E IG	0.24 – 0.27	0.50 – 0.55	0.61 – 0.68	41 – 45	CA, N
	Advanced Low-E IG	0.18 – 0.22	0.27 – 0.30	0.49 – 0.54	65 – 69	CA, N, NC
	SunDefense Low-E IG	0.18 – 0.22	0.20 – 0.22	0.45 – 0.50	65 – 69	CA, N, NC, SC, S
	NaturalSun Low-E IG	0.18 – 0.22	0.45 – 0.49	0.55 – 0.61	65 – 68	CA, N

Sound Performance	Frame Size Tested	Type of Glazing	Without Grilles	
			STC	OITC
			47" x 59"	13/16" Overall Thickness Dual-Pane
4mm / 4mm	28	24		
5mm / 3mm	31	26		
1" Overall Thickness Dual-Pane	4mm / 6mm	34		28
	6mm / 6mm	31		26
1" Overall Thickness Dual-Pane Sound Reduction Glass	4mm / 7mm PVB	34		29
1-1/4" Overall Thickness Dual-Pane Sound Reduction Glass	6mm / 12mm PVB	38		34
1" Overall Thickness Dual-Pane Impact Laminated Glass	11.7mm PVB / 5mm glass	36		32
	11.7mm SGP / 5mm glass	35		31
1-1/4" Overall Thickness Dual-Pane Impact Laminated Glass	13.6mm SPG / 6mm glass	37		31
1-3/8" Overall Thickness Triple-Pane Glazing	5mm / 5mm / 5mm	31	26	

Code Approvals:

Interior Glazed - Hallmark Certified; **FPAS#**: Standard = FL 10354; Impact Resistant = FL 20349 **TDI#**: Standard = WIN-1574; Impact Resistant = WIN-478

See the Performance section earlier in this manual to learn more about performance standards and ratings.

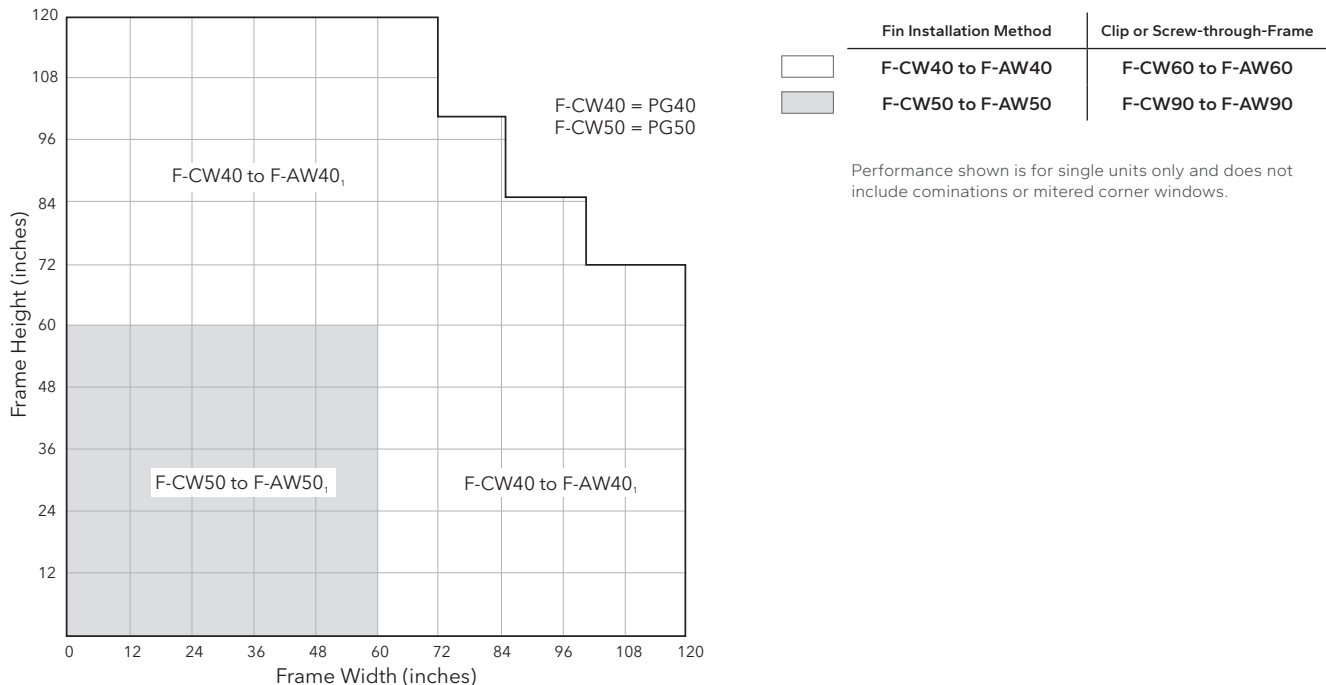

Maximum performance when glazed with the appropriate glass thickness.

Keep special size frame dimensions to the nearest 1/8" increment.

(1) AAMA / WDMA F-AW rating can be obtained with the EnduraClad Plus protective finish with 70% fluoropolymer resin in a multi-step finish.





Pella®
Lifestyle
Series

Fixed
Frame
Direct Set
Shapes



Shapes and Sizes – Interior Glazed

Description	Width		Height		Max. Glass Ft ²
	Min.	Max.	Min.	Max.	
Rectangle	8"	144"	8"	144"	76
Half Circle	24"	120"	12"	60"	48
Quarter Circle	12"	85"	12"	85"	48
Full Springline	24"	108"	R + 4.25"	120"	48
Half Springline	12"	85"	R + 4.25"	120"	48
Full Chord	24"	120"	10.5"	(W/2) - 1"	48
Partial Chord	9"	120"	10.5"	85.125"	48
Full Elliptical	32.5"	120"	R1 + 1.25"	< W/2	48
Partial Elliptical	14"	120"	R1 + 1.25"	60"	48
Full Arch Head	9"	120"	9"	120"	48
Partial Arch Head	9"	120"	9"	120"	48
Gothic Springline	9"	108"	14"	120"	48
Full Circle	24"	72"	24"	72"	—
Oval	Standard sizes only, 24" W x 36" H, 30" W x 48" H or 36" W x 60" H				

Rectangular and Angled Shapes

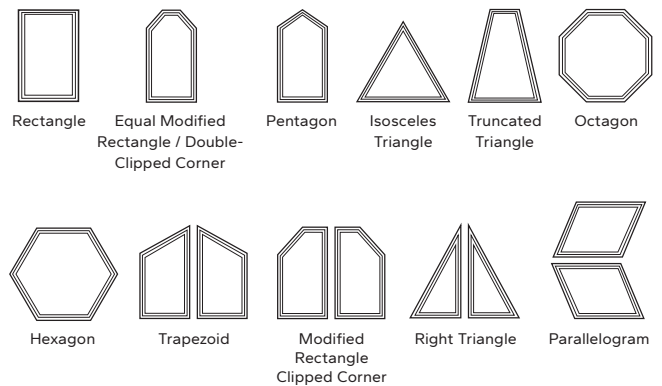

Curved Shapes

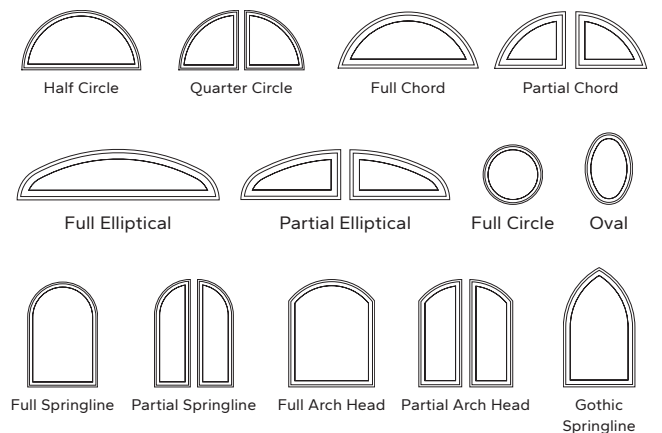

H=Height; S=Short Side; R=Radius, Angled and Curved frames are measured as a rectangle.

Pella angled and rectangular fixed frame direct set windows are available in custom shapes above. Not all options are shown. These windows may be installed in any orientation. For specifications, size limitations, and details on these units, contact your local Pella sales representative.





Pella®
Lifestyle
Series

Double-
Hung



**Air, Water,
& Structural
Performance**

Performance Class & Grade Rating	Water Penetration Resistance	Air Infiltration ₁	Design Pressure	Forced Entry
LC30 – LC50	7.5 psf	0.11	30 – 50 psf	10

**Thermal
Performance**

Vent Units

1 1/16" glass thickness, 2.5mm and 3mm

Type of Glazing (Argon fill)	U-Factor	SHGC	VLT %	CR	Energy Star® Capable
Advanced LowE IG	0.30 – 0.33	0.27 – 0.30	0.50 – 0.56	53 – 57	—
SunDefense™ Low-E IG	0.29 – 0.33	0.20 – 0.22	0.46 – 0.52	53 – 58	S
SunDefense+ Low-E IG	0.25 – 0.28	0.20 – 0.22	0.45 – 0.51	41 – 46	NC, SC, S
AdvancedComfort Low-E IG	0.26 – 0.28	0.26 – 0.29	0.48 – 0.55	41 – 46	—
NaturalSun LowE IG	0.30 – 0.34	0.49 – 0.56	0.56 – 0.64	52 – 57	CA
NaturalSun+ Low-E IG	0.26 – 0.29	0.44 – 0.51	0.55 – 0.62	41 – 45	CA, N

**Sound
Performance**

Frame Size Tested	Type of Glazing	STC	OITC
Vent; 37" x 59"	1 1/16" Overall IG thickness	27	23
Vent; 37" x 59"		31	27

Code Approvals: Hallmark Certified; FPAS#: Vent=12448; TDI#: Vent=WIN-739

See the Performance section earlier in this manual to learn more about performance standards and ratings. Performance varies based on actual product attributes.

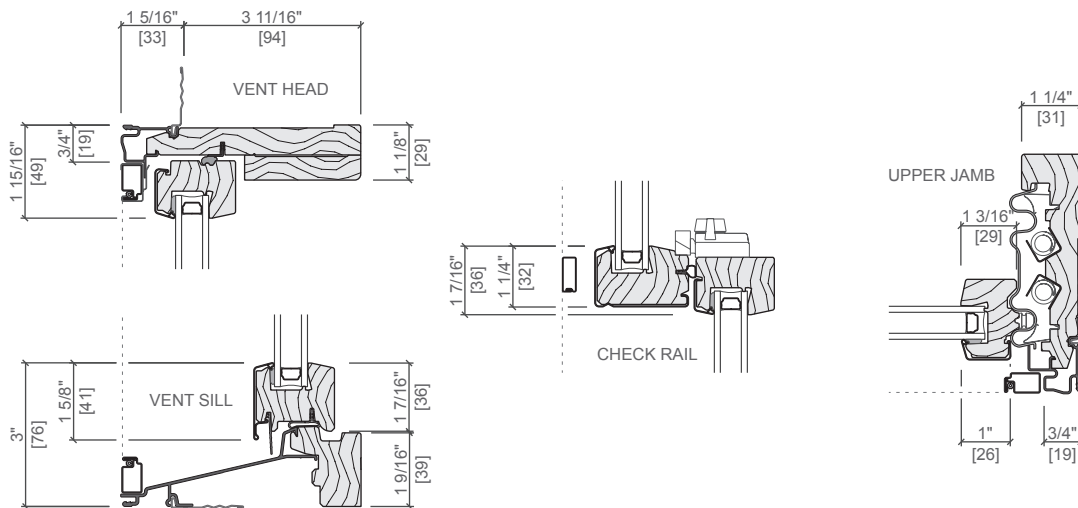

Other frame types are available. Not to scale. All dimensions are approximate.

Standard Sizes – Dual-Pane

Vent Units

	(552) (533)	(654) (635)	(755) (737)	(857) (838)	(959) (940)	(1 060) (1 041)	(1 162) (1 143)	(1 238) (1 219)
Opening	1' 9 3/4"	2' 1 3/4"	2' 5 3/4"	2' 9 3/4"	3' 1 3/4"	3' 5 3/4"	3' 9 3/4"	4' 0 3/4"
Frame	1' 9"	2' 1"	2' 5"	2' 9"	3' 1"	3' 5"	3' 9"	4' 0"
(908) (889)	2135	2535	2935	3335	3735	4135	4535	4835
(1 060) (1 041)	2141	2541	2941	3341	3741	4141	4541	4841
(1 213) (1 194)	2147	2547	2947	3347	3747	4147	4547	4847
(1 365) (1 346)	2153	2553	2953	3353	3753	4153	4553	4853
(1 467) (1 448)	2157	2557	2957	3357	3757	4157	4557	4857
(1 517) (1 499)	2159	2559	2959	3359	3759	4159	4559	4859
(1 670) (1 651)	2165	2565	2965	3365	3765	4165	4565	4865
(1 822) (1 803)	2171	2571	2971	3371	3771	4171	4571	4871
(1 975) (1 956)	2177	2577	2977	3377	3777	4177	4577	4877
(2 153) (2 134)	2184	2584	2984	3384	3784	4184	4584	4884

Special Sizes – Dual-Pane

Special Sizes are available in 1/4" increments.

Vent-Equal

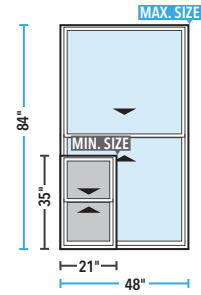

Transoms and Companion fixed windows available for combinations. See Casement window section for matching glass sightlines, or see the Fixed Frame Direct Set section for availability.

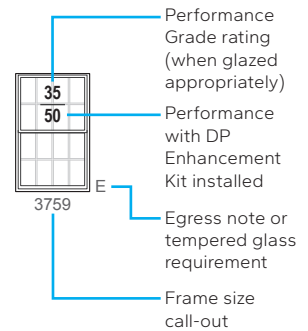

Egress Notes:

- E = Window meets minimum clear opening of 24" height, 20" width, and 5.7 sq. ft.
- E1 = Window meets minimum clear opening of 24" height, 20" width, and 5.0 sq. ft.

Check all applicable local codes for emergency egress requirements.

Maximum performance when glazed with the appropriate glass thickness.

Special size units are available in 1/4" increments.





Pella®
Lifestyle Series

In-Swing Door



Dual-Pane

Triple-Pane

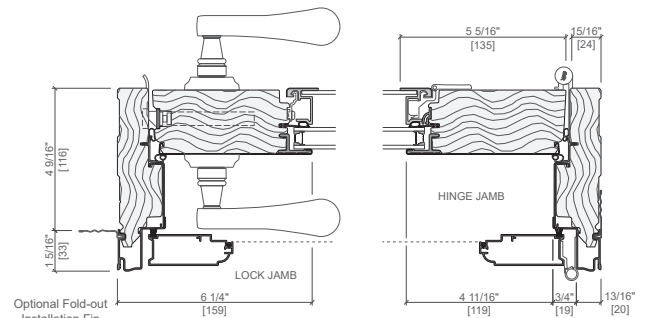
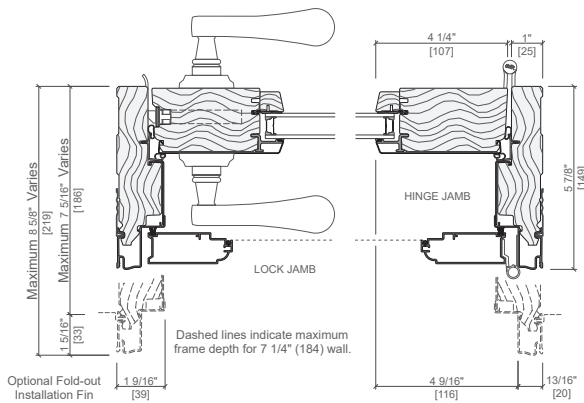
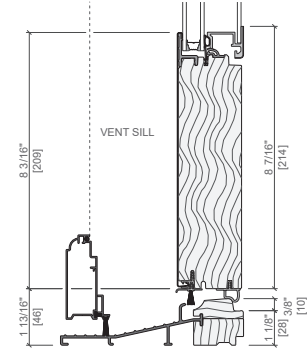
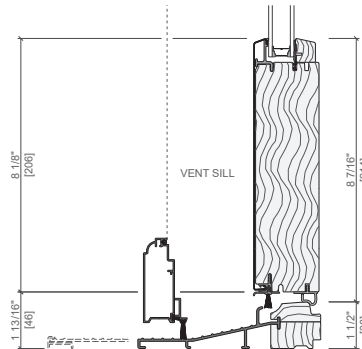
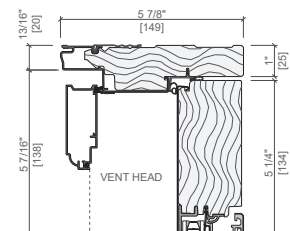
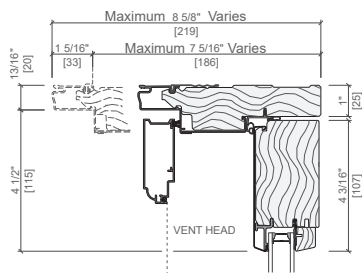

Other frame types are available.
Not to scale. All dimensions are approximate.

Triple-Pane Glazing

Air, Water, & Structural Performance	Performance Class & Grade Rating	Water Penetration Resistance	Air Infiltration	Design Pressure	Forced Entry
	LC55	8.36 psf	0.10	55 psf	Complies with AAMA 1304

Thermal Performance	Type of Glazing (Argon fill)	U-Factor	SHGC	VLT %	CR	Energy Star® Capable
French Doors 11/16" glass thickness, 3mm and 4mm, with clear ML (Triple-Pane)	Advanced LowE IG	0.24 – 0.27	0.16 – 0.19	0.28 – 0.34	67 – 68	N, NC, SC, S
	SunDefense™ Low-E IG	0.24 – 0.27	0.12 – 0.14	0.26 – 0.31	67 – 68	N, NC, SC, S
	SunDefense+ Low-E IG	0.22 – 0.24	0.12 – 0.14	0.25 – 0.30	68	N, NC, SC, S
	AdvancedComfort Low-E IG	0.23 – 0.24	0.15 – 0.18	0.27 – 0.33	68	N, NC, SC, S
	NaturalSun LowE IG	0.25 – 0.27	0.28 – 0.34	0.32 – 0.38	67 – 68	N, NC
	NaturalSun+ LowE IG	0.23 – 0.25	0.25 – 0.31	0.31 – 0.37	68	N, NC

Sound Performance	Frame Size Tested	Type of Glazing	STC	OITC	
	Active-Inactive; 71-1/4" x 81-1/4" A/I, w/ Blind, 71-1/4" x 81-1/4" A/I, w/ Shade, 71-1/4" x 81-1/4"	11/16" Overall IG thickness with Hinged-Glass-Panel	3mm/3mm/3mm (ML)	34	28
			5mm/3mm/4mm (ML)	35	31
			5mm/3mm/4mm (ML)	35	31
			5mm/3mm/4mm (ML)	35	31

Code Approvals: Hallmark Certified; **FPAS#**: Fixed and Vent = 16246; **TDI#**: Fixed and Vent = DR-218

Dual-Pane Glazing

Air, Water, & Structural Performance	Performance Class & Grade Rating	Water Penetration Resistance	Air Infiltration	Design Pressure	Forced Entry
	LC50	7.5 psf	0.15	50 psf	Complies with AAMA 1304

Thermal Performance	Type of Glazing (Argon fill)	U-Factor	SHGC	VLT %	CR	Energy Star® Capable
Vent Units 13/16" glass thickness, 3mm, Dual-Pane	Advanced LowE IG	0.27 – 0.30	0.20 – 0.23	0.37 – 0.43	58 – 62	SC, S
	SunDefense™ Low-E IG	0.27 – 0.30	0.15 – 0.18	0.35 – 0.40	59 – 62	SC, S
	SunDefense+ Low-E IG	0.24 – 0.25	0.15 – 0.17	0.34 – 0.39	46 – 49	N, NC, SC, S
	AdvancedComfort Low-E IG	0.24 – 0.26	0.20 – 0.23	0.36 – 0.42	45 – 49	N, NC, SC, S
	NaturalSun LowE IG	0.28 – 0.31	0.37 – 0.43	0.42 – 0.49	58 – 61	–
	NaturalSun+ LowE IG	0.24 – 0.26	0.34 – 0.39	0.41 – 0.48	44 – 48	N, NC

Sound Performance	Frame Size Tested	Type of Glazing	STC	OITC	
	Active-Fixed; 71-1/4" x 81-1/4"	13/16" Overall IG thickness	3mm / 3mm	30	24
			5mm / 3mm	32	28

Code Approvals: Hallmark Certified; **FPAS#**: FL 10346

See the Performance section earlier in this manual to learn more about performance standards and ratings.

Performance varies based on actual product attributes.



Standard Sizes – Dual-Pane

6' 7" Single Doors

FIXED VENT

(781)	(870)	(933)	(981)
(762)	(851)	(914)	(962)

Opening	2' 6 3/4"	2' 10 1/4"	3' 0 3/4"	3' 2 5/8"
Frame	2' 6"	2' 9 1/2"	3' 0"	3' 1 7/8"

(2 032)
(2 019)

6' 8"
6' 7 1/2"

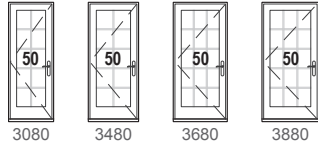

3080 3480 3680 3880

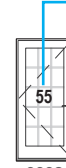

Performance Grade rating
(when glazed appropriately)
All doors and sidelights are
glazed with tempered glass.

3882

Frame size call-out

6' 10" Single Door

FIXED VENT

(2 083)
(2 070)

6' 10"
6' 9 1/2"

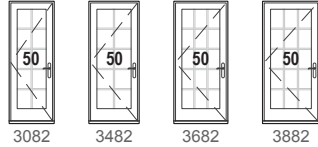

3082 3482 3682 3882

8' 0" Single Door

FIXED VENT

(2 438)
(2 426)

8' 0"
7' 11 1/2"

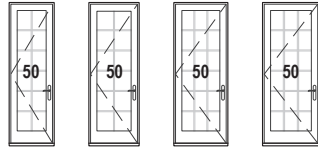

3096 3496 3696 3896

6' 7" Double-Swing Doors

ACTIVE-INACTIVE

(1 524)	(1 702)	(1 829)	(1 924)
(1 505)	(1 682)	(1 810)	(1 905)

Opening	5' 0"	5' 7"	6' 0"	6' 3 3/4"
Frame	4' 11 1/4"	5' 6 1/4"	5' 11 1/4"	6' 3"

(2 032)
(2 019)

6' 8"
6' 7 1/2"

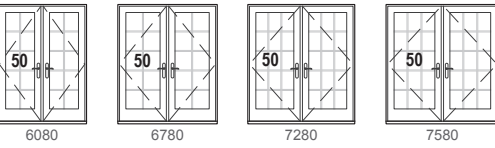

6080 6780 7280 7580

6' 10" Double-Swing Doors

ACTIVE-INACTIVE

(2 083)
(2 070)

6' 10"
6' 9 1/2"

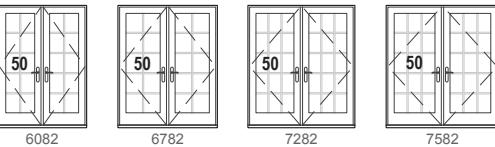

6082 6782 7282 7582

8' 0" Double-Swing Doors

ACTIVE-INACTIVE

(2 438)
(2 426)

8' 0"
7' 11 1/2"

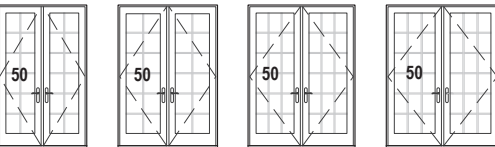

6096 6796 7296 7596

Not to scale.

Standard Sizes – Triple-Pane

6' 7" Single Doors and Sidelight

FIXED VENT

	(476) (457)	(781) (762)	(870) (851)	(933) (914)	(981) (962)
Opening	1' 6 3/4"	2' 6 3/4"	2' 10 1/4"	3' 0 3/4"	3' 2 5/8"
Frame	1' 6"	2' 6"	2' 9 1/2"	3' 0"	3' 1 7/8"

(2 032) (2 019)	6' 8"					
		1880	3080	3480	3680	3880

6' 10" Single Door

FIXED VENT

(2 083) (2 070)	6' 10"					
		1882	3082	3482	3682	3882

8' 0" Single Door

FIXED VENT

(2 438) (2 426)	8' 0"					
		1896	3096	3496	3696	3896

6' 7" Double-Swing Doors

ACTIVE-INACTIVE

	(1 524) (1 505)	(1 702) (1 682)	(1 829) (1 810)	(1 924) (1 905)
Opening	5' 0"	5' 7"	6' 0"	6' 3 3/4"
Frame	4' 11 1/4"	5' 6 1/4"	5' 11 1/4"	6' 3"

(2 032) (2 019)	6' 8"				
		6080	6780	7280	7580

6' 10" Double-Swing Doors

ACTIVE-INACTIVE

(2 083) (2 070)	6' 10"				
		6082	6782	7282	7582

8' 0" Double-Swing Doors

ACTIVE-INACTIVE

(2 438) (2 426)	8' 0"				
		6096	6796	7296	7596

Special Sizes – Triple-Pane

Single Door

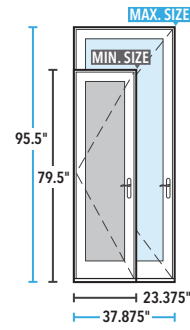

Double-Door (AI/IA)

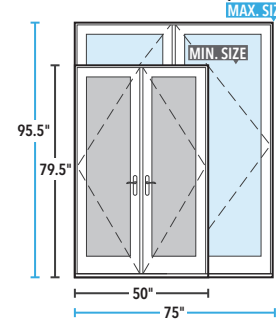

Double-Door (AF/FA)

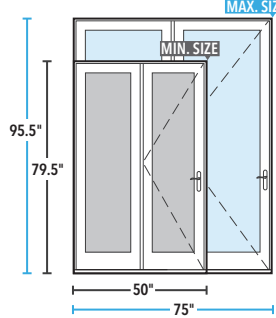

Keep frame dimensions to the nearest 1/4" increment.

All doors are glazed with tempered glass.

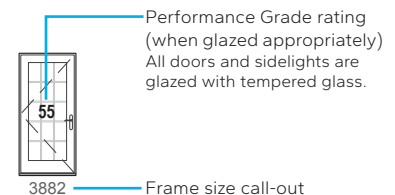



Pella®
Lifestyle
Series

Sliding
Door



Dual-Pane

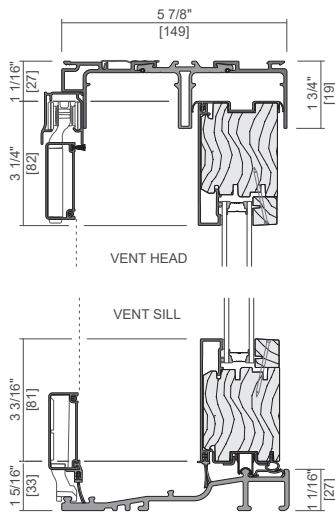

Triple-Pane

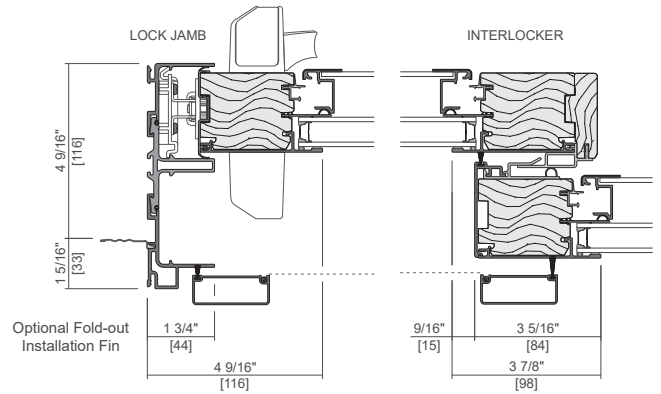
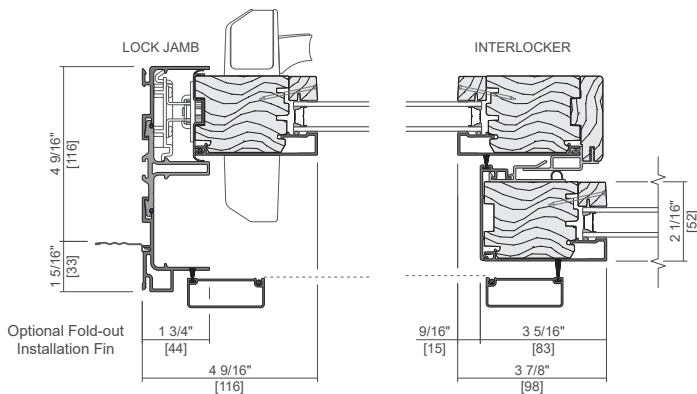
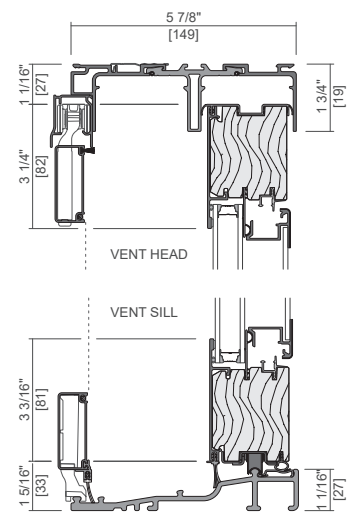

Three panel (OXO) and four panel (OXXO) configurations are also available.

Triple-Pane Glazing

Air, Water, & Structural Performance	Performance Class & Grade Rating	Water Penetration Resistance	Air Infiltration	Design Pressure	Forced Entry
	LC35 - LC50	5.43 - 7.52 psf	0.30	20 - 50 psf	40

Thermal Performance	Type of Glazing (Argon fill)	U-Factor	SHGC	VLT %	CR	Energy Star® Capable
3/4" glass glass thickness, 3mm and 3mm, with clear ML (Triple-Pane)	Advanced LowE IG	0.26	0.23 - 0.26	0.41 - 0.48	63	N, NC
	SunDefense™ Low-E IG	0.25	0.17 - 0.19	0.38 - 0.44	63	N, NC, SC, S
	SunDefense+ Low-E IG	0.23	0.17 - 0.19	0.37 - 0.43	63	N, NC, SC, S
	AdvancedComfort Low-E IG	0.23	0.22 - 0.25	0.40 - 0.46	63	N, NC, SC, S
	NaturalSun LowE IG	0.26	0.41 - 0.47	0.47 - 0.54	62	CA
	NaturalSun+ LowE IG	0.23	0.38 - 0.43	0.46 - 0.53	63	CA, N, NC

Sound Performance	Frame Size Tested	Type of Glazing	STC	OITC
	OX; 71.9" x 79.7"	3/4" Overall IG thickness with Hinged-Glass-Panel	3mm/3mm/3mm (ML)	26
	OX; 71.9" x 79.7"		4mm/6mm/4mm (ML)	29
	OX; 71.9" x 79.7" with Blind		4mm/6mm/4mm (ML)	29
	OX; 71.9" x 79.7" with Shade		4mm/6mm/4mm (ML)	29

Code Approvals: 411-H-1520; FPAS#: FL47325

Dual-Pane Glazing

Air, Water, & Structural Performance	Performance Class & Grade Rating	Water Penetration Resistance	Air Infiltration	Design Pressure	Forced Entry
	R20 - LC50	3.13 - 7.52 psf	0.30	20 - 50 psf	40

Thermal Performance	Type of Glazing (Argon fill)	U-Factor	SHGC	VLT %	CR	Energy Star® Capable
Vent Units 3/4" glass thickness, 3mm, Dual-Pane	Advanced LowE IG	0.30	0.25 - 0.28	0.45 - 0.52	54	-
	SunDefense™ Low-E IG	0.30	0.18 - 0.21	0.42 - 0.48	55	-
	SunDefense+ Low-E IG	0.26	0.18 - 0.20	0.41 - 0.47	45	N, NC, SC, S
	AdvancedComfort Low-E IG	0.26	0.24 - 0.27	0.44 - 0.51	44	N, NC
	NaturalSun LowE IG	0.31	0.45 - 0.51	0.51 - 0.59	54	-
	NaturalSun+ LowE IG	0.27	0.41 - 0.47	0.50 - 0.57	43	-

Sound Performance	Frame Size Tested	Type of Glazing	STC	OITC
	OX (Fixed-Vent); 71.9" x 79.7"	3mm / 3mm	28	24
		4mm / 6mm	31	27

Code Approvals: 411-H-1520; FPAS#: FL47325

See the Performance section earlier in this manual to learn more about performance standards and ratings.

Performance varies based on actual product attributes.



Standard Sizes – Dual-Pane

Opening	5' 0" (1 524)	6' 0" (1 829)	7' 0" (2 134)	8' 0" (2 438)	10' 0" (3 048)
Frame	4' 11 1/4" (1 505)	5' 11 1/4" (1 810)	6' 11 1/4" (2 115)	7' 11 1/4" (2 419)	9' 11 1/4" (3 029)
6' 8" (2 032) 6' 7 1/2" (2 019)					
6' 10" (2 083) 6' 9 1/2" (2 070)					
8' 0" (2 438) 7' 11 1/2" (2 426)					
9' 0" (2 743) 8' 11 1/2" (2 731)					
10' 0" (3 048) 9' 11 1/2" (3 035)					

Two panel doors—Fixed-Vent (OX), right panel opens, left panel is fixed. Units open in the direction of the arrow as viewed from the exterior.

Vent-Fixed (XO) doors are also available.

Three-Panel (OXO), and-Four Panel (OXXO) are also available in standard sizes, matching the standard heights shown in this size table.

Contact your local Pella sales representative for details and restrictions of knock-down frames for on-site assembly.

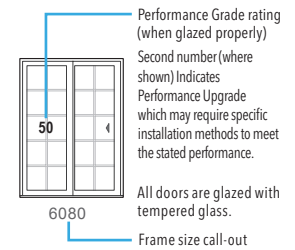

Transoms	(800) (781)	(953) (933)	(1 105) (1 086)	(1 257) (1 238)	(1 524) (1 505)	(1 829) (1 810)	(2 134) (2 115)	(2 438) (2 419)
Opening	2' 7 1/2"	3' 1 1/2"	3' 7 1/2"	4' 1 1/2"	5' 0"	6' 0"	7' 0"	8' 0"
Frame	2' 6 3/4"	3' 0 3/4"	3' 6 3/4"	4' 0 3/4"	4' 11 1/4"	5' 11 1/4"	6' 11 1/4"	7' 11 1/4"
1' 2" (375) 1' 1 1/2" (356)								
1' 5" (451) 1' 4 1/2" (432)								
2' 1" (654) 1' 11 1/4" (635)								

Not to scale. Ratings based on Direct Set transom.

T Tempered glass is standard.

Not to scale.

All doors are glazed with tempered glass.

Standard Sizes – Triple-Pane

Opening	5' 0" (1 524)	6' 0" (1 829)	7' 0" (2 134)	8' 0" (2 438)
Frame	4' 11 1/4" (1 505)	5' 11 1/4" (1 810)	6' 11 1/4" (2 115)	7' 11 1/4" (2 419)
6' 8" (2 032) 6' 7 1/2" (2 019)	 2 Panel (OX) 6080	 2 Panel (OX) 7280	 2 Panel (OX) 8480	 2 Panel (OX) 9680
6' 10" (2 083) 6' 9 1/2" (2 070)	 2 Panel (OX) 6082	 2 Panel (OX) 7282	 2 Panel (OX) 8482	 2 Panel (OX) 9682
8' 0" (2 438) 7' 11 1/2" (2 426)	 2 Panel (OX) 6096	 2 Panel (OX) 7296	 2 Panel (OX) 8496	 2 Panel (OX) 9696

Two panel doors—Fixed-Vent (OX), right panel opens, left panel is fixed. Units open in the direction of the arrow as viewed from the exterior.

Vent-Fixed (XO) doors are also available.

Three-Panel (OXO), and-Four Panel (OXXO) are also available in standard sizes, matching the standard heights shown in this size table.

Contact your local Pella sales representative for details and restrictions of knock-down frames for on-site assembly.

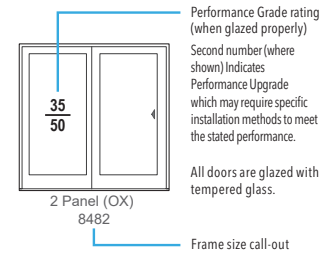

Special Sizes

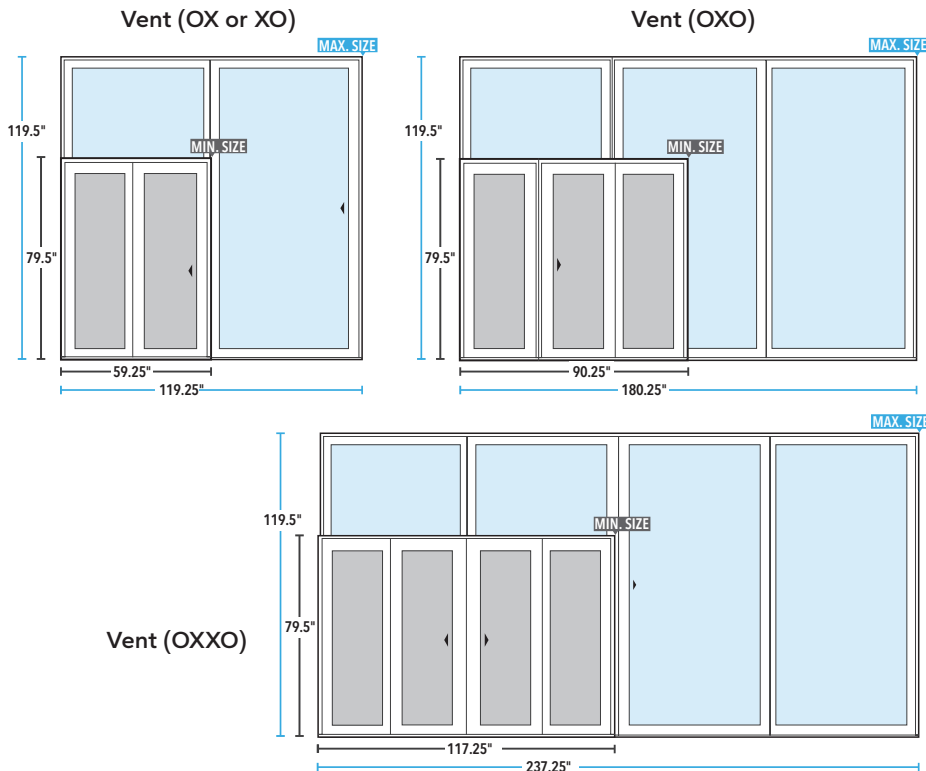

Keep special size frame dimensions to the nearest 1/4" increment for 2 panel units, 1/2" for 3 and 4 panel units.

All doors are glazed with tempered glass.

