



# SCENESCAPE MULTI-SLIDE 1-WAY POCKET DOOR KNOCK-DOWN ASSEMBLY AND INSTALLATION INSTRUCTIONS

## Parts List:

- Head
- Jamb (x2)
- Sill
- 10" shims for sill



- Sealant
- Hardware skin card



- Head Assembly Screws



- Interior trim Torx head finish screw



- Sill Assembly Screw



- Installation Kit Box

- T10 Torx Bit
- #2 Square Bit



- Frame Installation Screw



## Tool List:

- Screwdriver with Phillips drive bit
- Powered driver with Phillips drive bit
- Flat blade screwdriver
- #2 Phillips screwdriver with 8" long blade
- Rubber mallet
- Tape measure
- Level
- Laser level
- Shims
- Wood support blocks
- Wood block
- Sealant gun with sealant
- Ladder
- Drywall square/ square
- Pilot drill - w/ 1/16", 7/64", 1/8"x6" Long drill bits
- Staple gun
- Finish nail gun
- #2 Square drive screw bit
- 5/32" Lag screw drive bit

Before purchasing and installing, verify performance of product meets the requirements of the application and region. Not all products or sill types are rated for water performance. To reduce the likelihood of water infiltration where application exceeds product performance, install doors under an overhang that extends to meet a 45 degree line from the door sill and slope the exterior 2 degrees away from the door or use a stepdown.

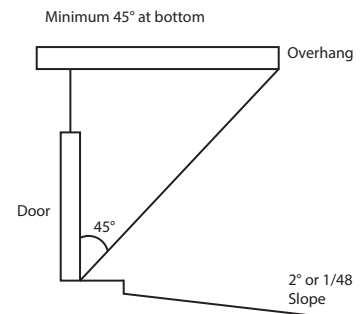

**FAILURE TO DO SO MAY RESULT IN DAMAGE TO THE INTERIOR OF THE STRUCTURE.**



Always read the Limited Warranty before purchasing or installing Pella® products. By installing this product, you are acknowledging that this Limited Warranty is part of the terms of the sale. Failure to comply with all Pella installation and maintenance instructions may void your Pella product warranty. See written Limited Warranty for details, including exceptions and limitations at [pella.com/warranty](http://pella.com/warranty), or contact Pella Customer Service at 877-473-5527.

**NOTE:**

- Header must be designed to bear the weight of all building (roofing) and construction loads. Maximum allowable header deflection of 1/8" over total span of the opening.
- Sill structure and framing must be designed and constructed to carry the weight of the door frame and door panels.

**Installation Instructions for Typical Wood Frame Construction.**

These instructions were developed and tested for use with typical wood frame wall construction in a wall system designed to manage water. **These instructions are not to be used with any other construction method.**

Installation instructions for use with other construction methods may be obtained from Pella Corporation, a local Pella retailer, or by visiting <http://www.pella.com>. Building designs, construction methods, building materials, and site conditions unique to your project may require an installation method different from these instructions and additional care. Determining the appropriate installation method is the responsibility of you, your architect, or construction professional.

# PELLA® SCENESCAPE™ MULTISLIDE POCKET DOOR INSTRUCTIONS

**Parts List:**

- Wood Interlocker
- Clad Interlocker
- Pella SmartFlash™ Tape
- Pocket interlocker #12 x 4" lag type screws



- Clad interlocker screws #8 x 3" pan head



**Tool List:**

- Screwdriver with Phillips drive bit
- Powered driver with Phillips drive bit and lag head bit.
- Flat blade screwdriver
- Rubber mallet
- Tape measure
- Wood block
- Ladder

## 1 Pocket Door Opening Prep:

A. Prior to sill prep, inspect the rough opening to ensure it is plumb, level and square. Confirm sill subfloor is level, using shims as needed.

B. Measure opening to confirm all existing measurements agree with those appearing on the elevation drawings provided. Measurements should be within + 1" from side to side. Measurements from top to bottom should match the provided drawing.

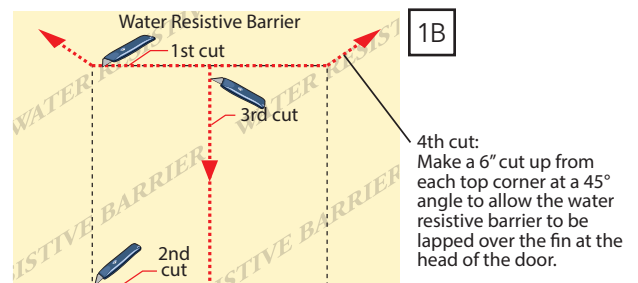

# 1 Pocket Door Opening Prep (continued):

C. Cut the building wrap.

D. Fold the building wrap in at the jambs and staple it in place. Fold the top flap up and temporarily fasten with flashing tape.

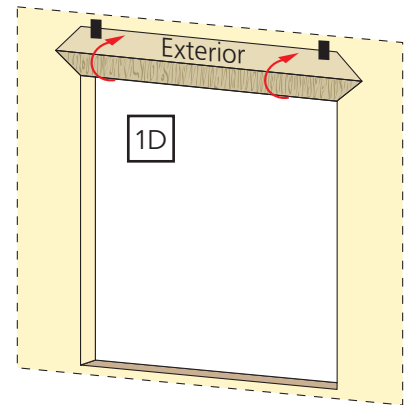

E. Begin at the exterior on the pocket side and apply flashing tape (tape #1) extending 1" to the exterior and 6" up the jamb. Place a piece of flashing tape across the exterior corner overlapping tape #1.

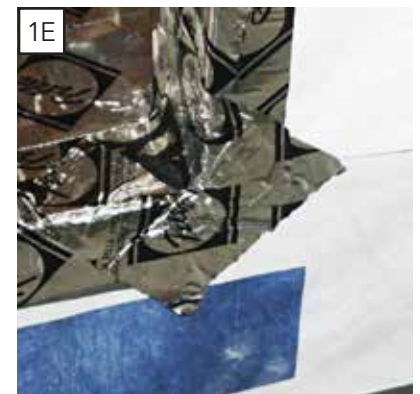
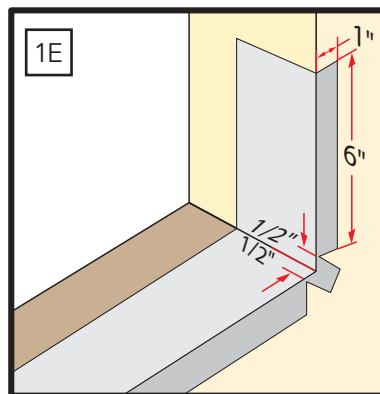

F. Continue to apply flashing tape across the length of the sill extending 1" to the exterior and 6" up the opposite jamb. Fold the tape over to the exterior. Place a piece of flashing tape across the exterior corner overlapping tape #1.

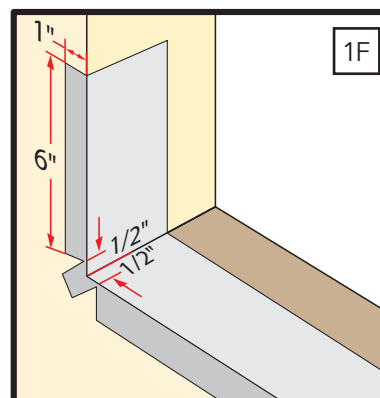

# 1 Pocket Door Opening Prep (continued):

G. Starting on the back side of the exterior wall of the pocket, apply a piece of sill flashing tape (Tape #2) to the framing with the tape edge on the sill.



H. Continue applying the tape across the framing, around the corner to the inside edge of the pocket.



I. Starting at the corner in the backside of the pocket, apply a 3rd piece of flashing tape overlapping tape #2 by at least 1". Work across the sill and apply the flashing tape 6" up the opposite jamb.

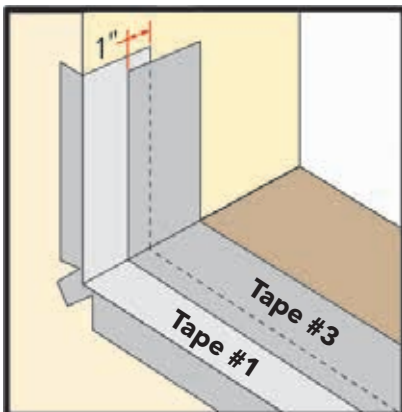

# 1 Pocket Door Opening Prep (continued):

- J. Continue to apply addition pieces of flashing tape across the sill, overlapping the previous piece by at least 1" until the sill is covered with flashing tape and up each jamb 6".

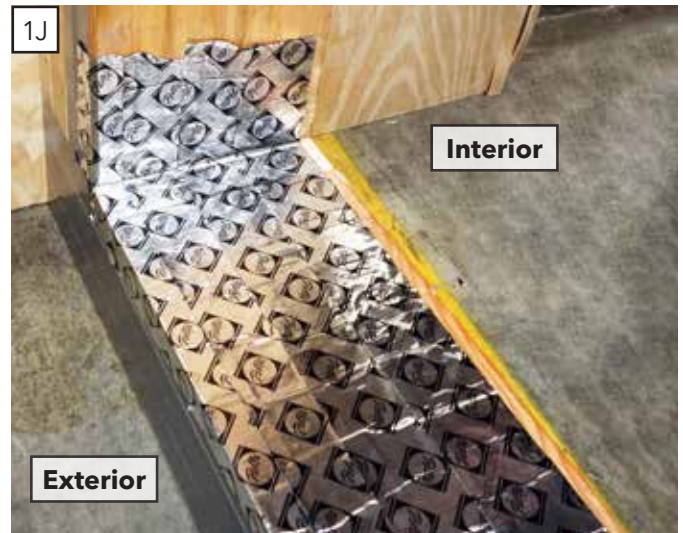

- K. For installing on a concrete slab, see instruction on page 38.

- L. Use a #2 square drive bit to remove the TOP screws on the frame crate.

Remove the top of the crate.

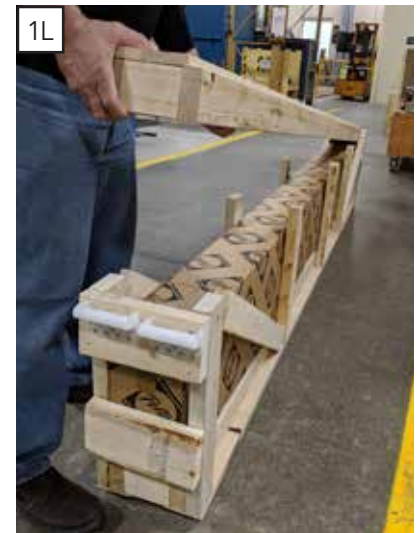

- M. Lift the box flap to open the box and remove parts from the top of the crate.

**Note: Installation kit parts and handle hardware are shipped separately and are not contained in this crate.**



## 2 Frame Assembly:

- A. Lay the head track, sill track and side jambs exterior side up on a clean flat surface in the orientation in which they will be assembled, (matching the numbers in each corner). Insert wood blocks under each corner to support and level the corners on an uneven surface.

Use care if using an impact driver during the Frame Assembly Process. If not careful, impact drivers can cause to screw head breakage.

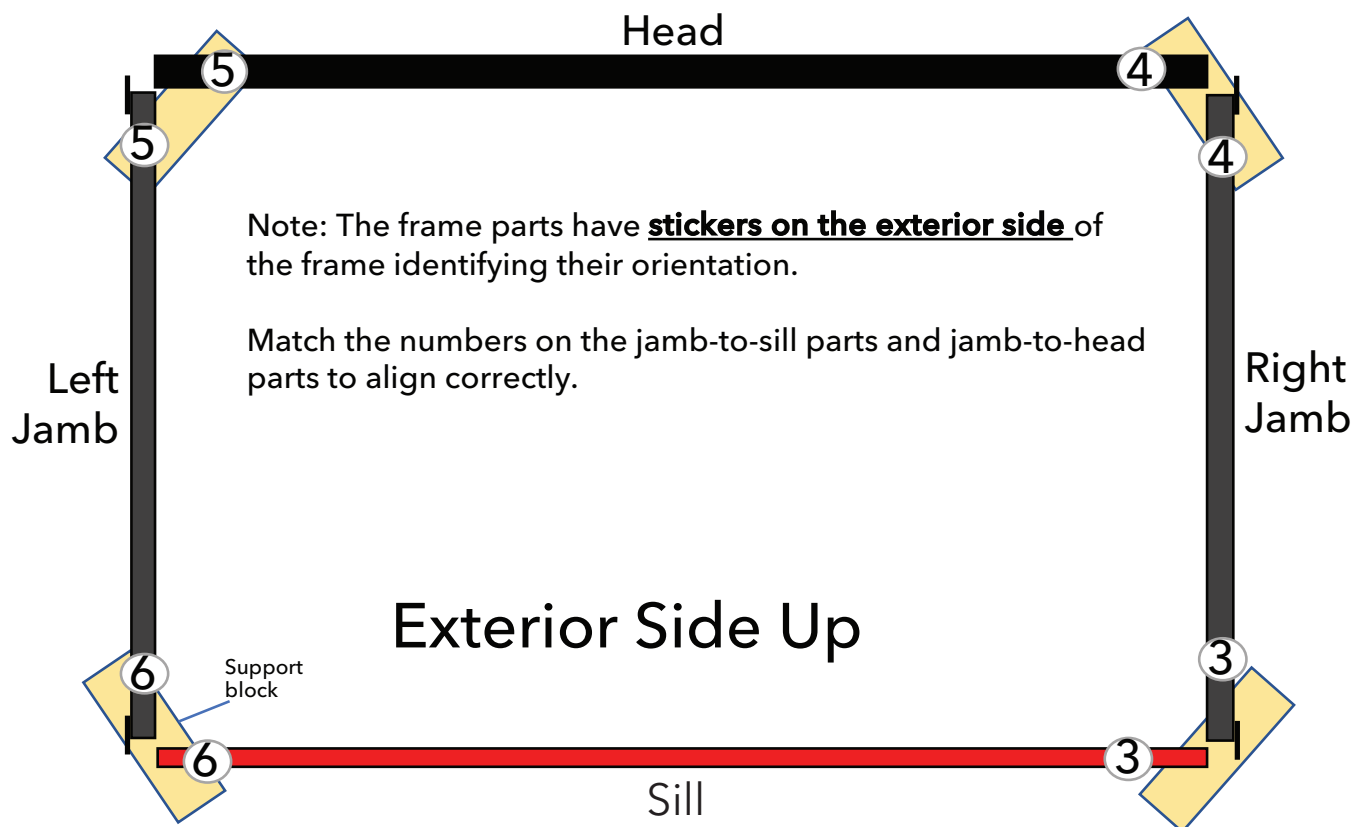

Examples showing sticker locations with matching frame corner numbers.



## 2 Frame Assembly (continued):

Assemble the frame starting in one corner and work around the frame assembling each corner before moving to the next.

### FIRST SILL TO JAMB CORNER:

- B. Begin at one end and remove the green adhesive release liner from the top of the sill corner block.

*Note: 1-1/2" Weep Sill shown in frame assembly steps. The Frame Assembly process is similar for 1" Integrated Sill and 1/2" Surface Mount Sill.*

*Note: Sill track is shipped with protective tape. Pella recommends leaving tape on until the entire building construction process is complete.*



- C. With the numbers on the sill and jamb matching, position the sill and jamb corner together.



**Screws will be inserted and installed here.**

**Note numbers matching**

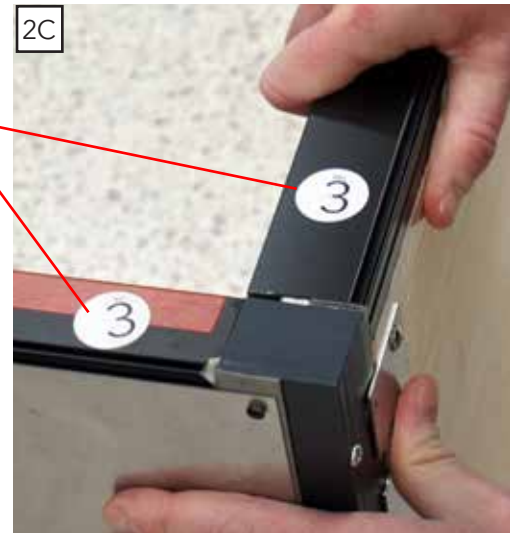

- D. Position the sill and jamb corner together and fasten through the bottom jamb assembly plate using the provided sill assembly screws.

**Use care if using an impact driver during the Frame Assembly Process. If not careful, impact drivers can cause to screw head breakage.**

**\*\*NOTE\*\*** Frame screw packages accommodate up to 8-track systems. Excess screws may be present.

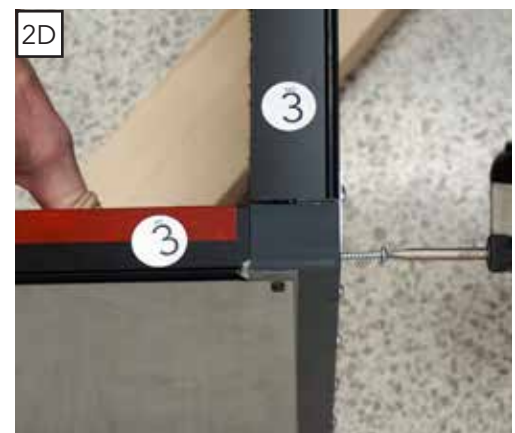

## 2 Frame Assembly (continued):

### FIRST JAMB TO HEAD CORNER:

E. At the top of the jamb, peel the adhesive release liner from the top jamb assembly plate.

F. Locate the two head and jamb screw packages labeled with the matching corner numbers. Note the bottom-row screws are longer than the top-row.

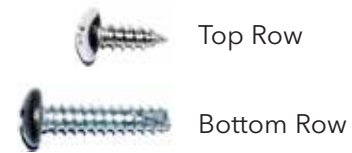

**\*\*NOTE\*\*** Frame screw packages accommodate up to 8-track systems. Excess screws may be present.

*Note: Orientation shows frame after tipped upright for installation.*

G. Insert a bottom-row screw into the jamb assembly plate piercing the tape to help align with the screw boss on the head.

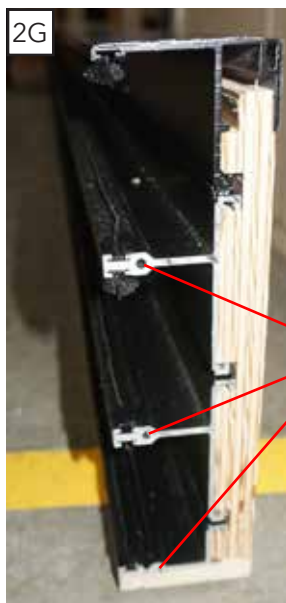

Screws will be inserted into the Bosses and installed here.



Pierce the tape with one of the bottom row screws to assist with screw to screw boss alignment.



## 2 Frame Assembly (continued):

### FIRST JAMB TO HEAD CORNER:

- H. Align and fit the side jamb to the head, assuring screw is aligned with the screw boss located in the head track.



Bottom Row

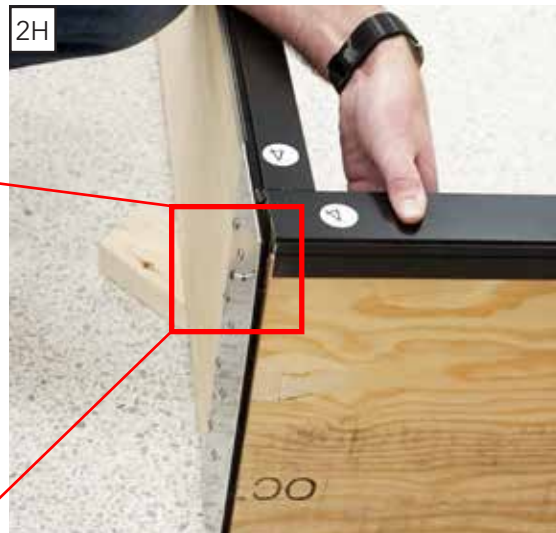

Use care if using an impact driver during the Frame Assembly Process. If not careful, impact drivers can cause to screw head breakage.

- I. Insert and finish driving the screws. Be careful not to overtighten or strip the screw heads.



Bottom Row

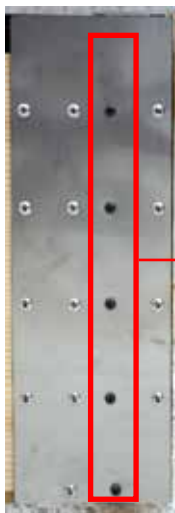

Bottom Row Screws



- J. Insert and tighten all the "top" row screws.



Top Row



Top Row Screws



## 2 Frame Assembly (continued):

Use care if using an impact driver during the Frame Assembly Process. If not careful, impact drivers can cause to screw head breakage.

### POCKET JAMB TO HEAD CORNER:

Repeat E - J on the other side of the head and the jamb.  
Follow the same process for pocket jamba.



### POCKET JAMB TO SILL CORNER:

Repeat B - D on the other side of the sill and the jamb. Follow the same process for pocket jamba.



# 3 Setting and Fastening the Frame Sill:

A. Measure the location of the screw hole slots on the bottom side of the sill. Use these measurements to position the sill shims adjacent to the screw locations on the sill rough opening.

Measure and mark the interior edge of the sill on the bottom of the rough opening.



B. Using a Laser level, confirm the rough opening sill is level. If the sill is not level, place extra shims at the sill screw hole locations across the length of the sill to ensure level sill when installing. Attach shims with staples or flashing tape.

**Note:** *Provided sill shims have "tear-apart" design to ensure proper fit.*

**Note:** *Weep Sill shown in Steps 3C-3G. The Frame Setting and Fastening process is similar for the integrated Sill and Surface Mount Sill.*



C. POCKET DOOR FRAMES: From the Interior, raise the frame to an upright position in front of the rough opening. Confirm rough opening clearances are adequate per recommendations.



### 3 Setting and Fastening the Frame Sill (continued):

D. Lift and place the frame sill first into the rough opening, then tilt in the head. Position the exterior edge of the frame against the interior side of the exterior pocket wall, centering the frame within the rough opening.



E. On the interior side of the rough opening apply a 3/8" thick bead of sealant across the sill recessed 1/2" from the interior edge of the frame across the full length of the rough opening and 6" up each jamb.



F. **LIFT** the frame up and move it back toward the interior on top of the sealant bead, (DO NOT slide) to place the frame in the final position with a 1" gap between the exterior side of the frame and the interior side of the exterior wall framing.



# 3 Setting and Fastening the Frame Sill (continued):

G. Drill a 1/8" pilot hole and insert 1 installation screw near the top of each jamb to temporarily hold the frame in place to aid in plumb, level and square process.



Exterior Pocket Wall

## 1-1/2" WEEP SILL - TRACK COVER REMOVAL:

H. Remove the interior and exterior sill track covers. Begin on one end of a cover by inserting a stiff blade putty knife between the interior track cover and the track. Tap the putty knife with a hammer to assist in starting the track removal process. Pry the cover off working along the length of the sill cover.

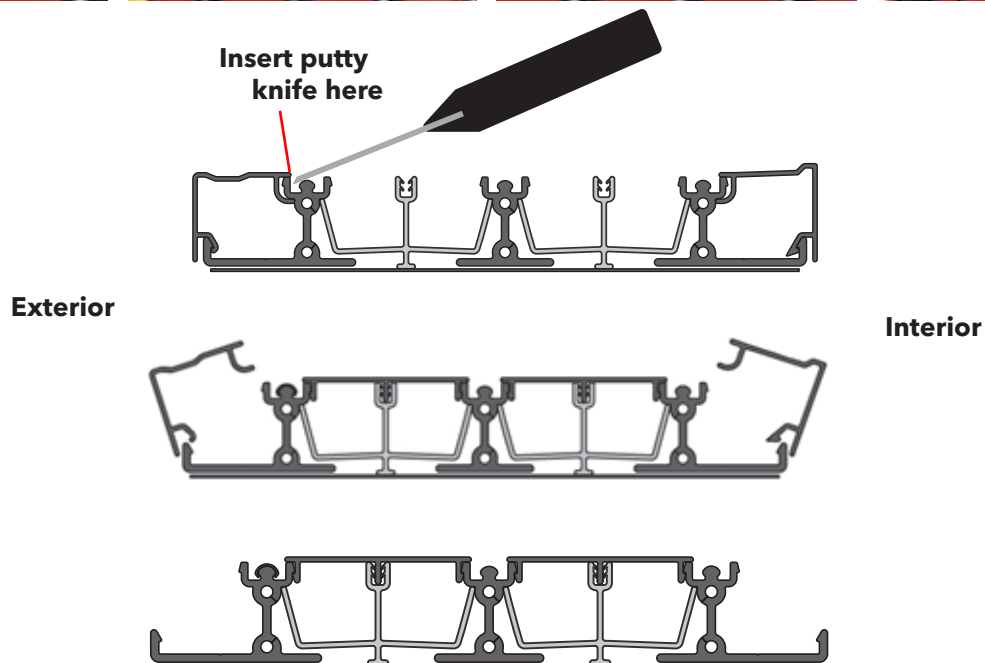

Repeat on the other track cover.

# 3 Setting and Fastening the Frame Sill (continued):

## SILL TRACK OPTIONS:

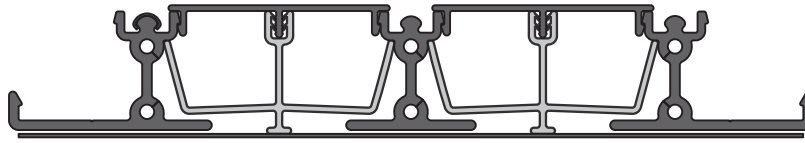

1-1/2" Weep Sill

Exterior



Interior

1" Integrated Sill



1/2" Surface Mount Sill

*Note: Weep Sill shown in Sill Fastening process steps. The Sill Fastening process is similar for the Integrated Sill and Surface Mount Sill.*

## SILL FASTENING:

- I. Confirm sill has not moved during cover removal process
- J. Using a laser level, confirm the sill is level.

At every shim (screw) location, check the interior and exterior of the sill for level. There should be no more than a 1/16" difference from interior to exterior. There should be no more than a 1/4" difference across the full length of the track, and no more than 1/16" between each fastener location. Insert shims as needed.



### 3 Setting and Fastening the Frame Sill (continued):

- K. Pilot drill using a 1/8" drill bit into the rough opening at all sill hole locations.



- L. Inject sealant into every installation hole on both sides of the sill. DO NOT place sealant in the exterior weep slots.



- M. Fasten the sill to the rough opening using frame installation screws. Adjust sill to level by adding shims as needed at or near the screw installation holes while working across the length of the sill. Use the laser level to confirm the sill is fastened level.



**Frame Installation Screw**

- N. Place a continuous bead of sealant across the inner sill at the intersection of the door sill and subfloor. Continue the sealant 6" up each jamb.

**Note: Use a low odor, paintable sealant such as Pella Window and Door Installation Sealant.**



### 3 Setting and Fastening the Frame Sill (continued):

#### 1-1/2" WEEP SILL TRACK COVER INSTALLATION:

*Note: The interior sill track cover has foam weatherstrip in the groove that goes next to the track. Make sure the cover with the foam is installed on the interior. The presence of the foam will require a bit more pressure to be applied when installing the interior cover.*

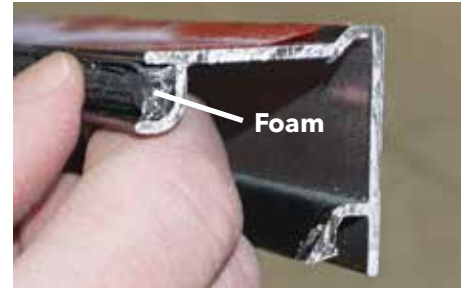

O. Place the track cover in the correct orientation against the track at one jamb. Bow the cover away from the sill slightly in the center to install the other end against the opposite jamb



P. Start on one end and push on the face of the Cover while rotating it down to seat it into place. Continue to press the cover in place along the length of the sill. At the other sill end, push on the face of the track cover and press down to seat.



Repeat on the other track cover, be sure the track cover is completely seated on the sill.



# 3 Setting and Fastening the Frame Sill (continued):

## OPTIONAL WEEP SILL RAMP INSTALLATION PROCEDURE:

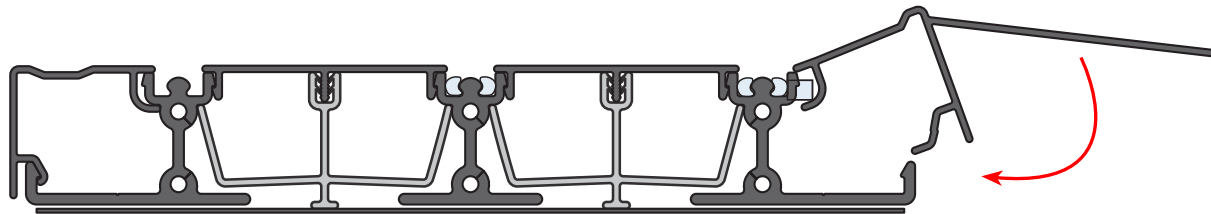

Q. Place the track cover in the correct orientation against the track at one jamb. Bow the cover away from the sill slightly in the center to install the other end against the opposite jamb



R. Start on one end and push on the face of the cover while rotating it down to seat it into place. Continue to press the cover in place along the length of the sill. At the other sill end, push on the face of the track cover and press down to seat.



Repeat on the other track cover, be sure the track cover is completely seated on the sill.

# 3 Setting and Fastening the Frame Sill (continued):

## 1/2" SURFACE MOUNT SILL TRACK COVER INSTALLATION:

S. Align the track cover cut-outs with the screw head cut-outs on the sill.



T. Position the cover on the track and tap into place using a block of wood and mallet.



**Tap into position  
with block of wood**



Repeat on the other track cover, be sure the track cover is completely seated on the sill.



# 4 Fastening the Vent Frame Jamb:

A. Check for square often before fastening the frame jambs.



B. Near the exterior edge of the jamb, remove the tape which temporarily holds the installation screw cover in place and remove the cover.



# 4 Fastening the Vent Frame Jamb (continued):

C. While securely holding the frame in place, back out the screw installed in 5G. Position the jamb in the opening plumb and level.

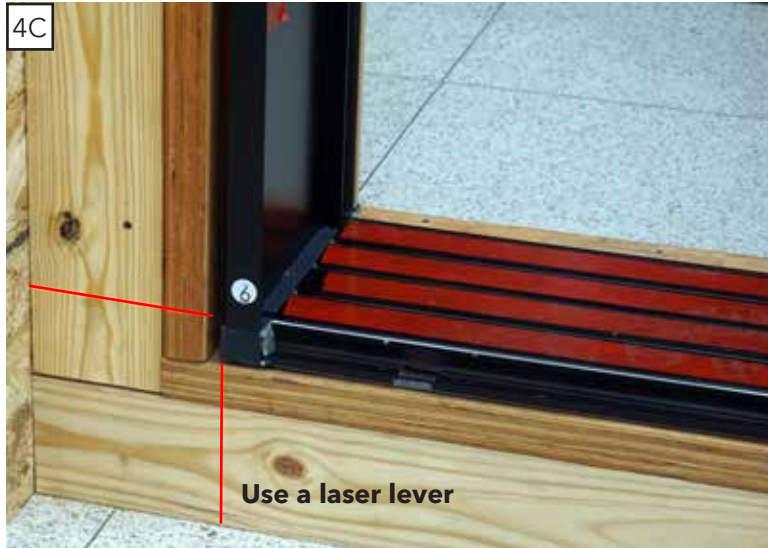

Use laser level to check vertical plumb, level & square inside the rough opening.



Use level to check plumb of frame to confirm frame is straight up and down in the opening.

D. Pilot drill using a 1/8" drill bit into the rough opening at all vent jamb installation screw hole locations, including the holes in the lock strike.



Exterior



Strike



Interior



Frame Installation Screw

# 4 Fastening the Vent Frame Jamb (continued):

E. Install the exterior side frame installation screws in the pre-drilled screw locations which were under the installation screw cover, making sure to shim and check for plumb, level and square as each installation screw is installed.



F. Install the remaining installation screws being sure to shim and check for plumb, level and square as each installation screw is installed.



**Frame  
Installation  
Screw**

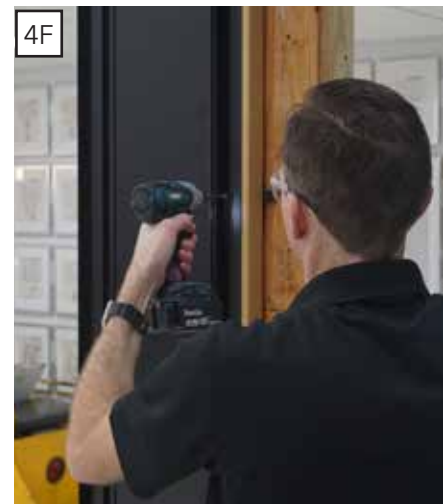

G. Shim behind the strike and install the installation screws in the open screw locations.



## 4 Fastening the Vent Frame Jamb (continued):

H. Re-install the installation screw cover and tap in place with a wood block and a rubber mallet along the length of the cover.



## 5 Fastening the Fixed Frame Jamb:

A. Remove the screw installed in 3G on one side of the frame. Pilot drill using a 1/8" drill bit into the rough opening at the top middle and bottom of the jamb.

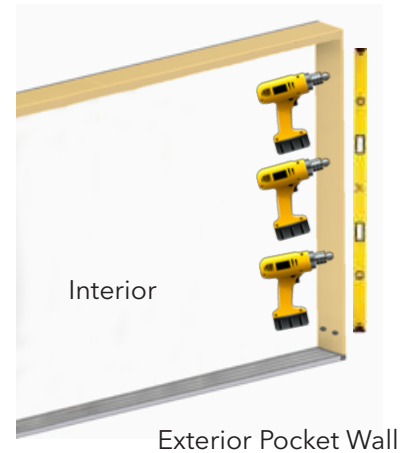

**Frame Installation Screw**

B. Install the frame installation screws in the pre-drilled screw locations, making sure to shim and check for plumb, level and square as each installation screw is installed.



# 6 Setting and Fastening the Head:

A. On the exterior side, measure the frame opening height at each jamb and cut a board to use as a gauge/guide to help level the head to the height of the frame opening at the jambs.

**Note:** Position the gauge board in the frame at each installation screw hole location to confirm the frame opening height across the entire opening when installing the screws.



Measuring for gauge board



Positioning gauge board

**Note:** An alternate head fastening method is to use a tape measure at each installation screw location to confirm the same frame opening height across the opening identical to the height at each jamb.

Do NOT place gauge board here



Exterior

Interior



**IMPORTANT:** When positioning the gauge board near the interior, make sure the board is not placed on the interior sill cover lip.

# 6 Setting and Fastening the Head (continued):

B. Starting in the center of the frame width, position the gauge board plumb near the center installation holes. Pilot drill (1/8") into the rough opening at all the center installation screw hole locations.



C. Shim at the exterior and interior of the center installation screw hole location.



**Frame Installation Screw**

D. Install the center head installation screws. Reposition the gauge board toward the interior when moving from the exterior to interior.



**Reminder: Make sure the gauge board is not placed on the interior cover lip.**

Do NOT place gauge board here



Exterior

Interior



## 6 Setting and Fastening the Head (continued):

- E. Once the center is secure, begin moving toward each end of the head. Move the gauge board near each installation hole and pilot drill, shim and fasten the head at each screw location. Confirm the frame opening height measurement is identical at all points along the width of the opening.

## 7 Panel Installation:

Every panel will have two labels;

1. Identifies the door configuration.
2. Identifies the panel location from the left jamb as viewed from the exterior.

Panels are typically installed from the exterior, beginning with the most interior panel first and each panel in the sequence follows in order, making sure the interlockers engage.

### EXTERIOR INSTALLATION SEQUENCE IS SHOWN IN THE FOLLOWING STEPS.

Panels may be installed from the interior, beginning with the most exterior panel first and each panel in the sequence follows in reverse order, making sure the interlockers engage.



This instruction example shows a 5 panel door with a pocket.



# 7 Panel Installation (continued):

- A. Identify the interior most panel. From the exterior, insert the most interior panel into the frame. Start by inserting the top of the panel into the interior most head track, and sliding the bottom of the panel into vertical alignment, making sure the rollers are aligned with the track.

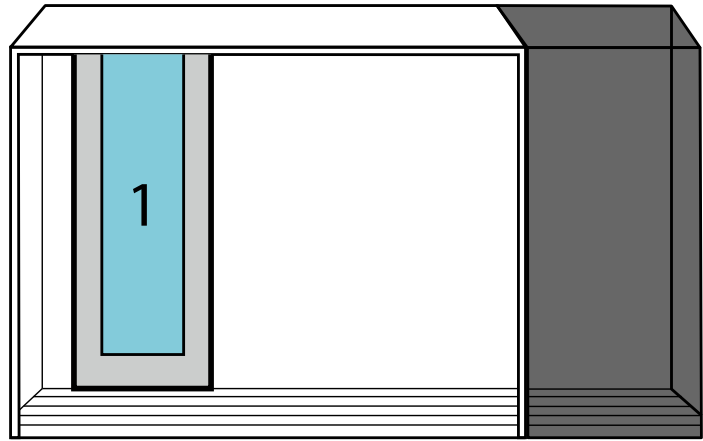
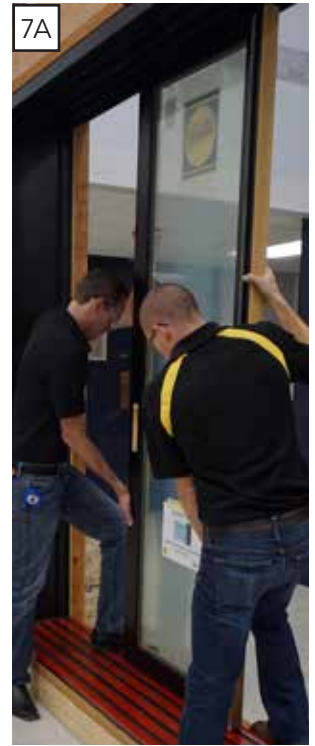

- B. Remove the plastic caps over the panel adjustment holes and insert an 8" long bladed Phillips screwdriver into the hole and adjust the height of each side of the panel so it is approximately 1/4" above the track.



# 7 Panel Installation (continued):

- C. Slide the panel over to the vent frame jamb and confirm the panel to frame reveal is even along the height of the panel. Adjust roller/panel height as needed. Adjust rollers up when leveling rather than down to bias the panel into the head of the unit. Also check to ensure weatherstrips on the bottom of the panels maintain contact with the sill.

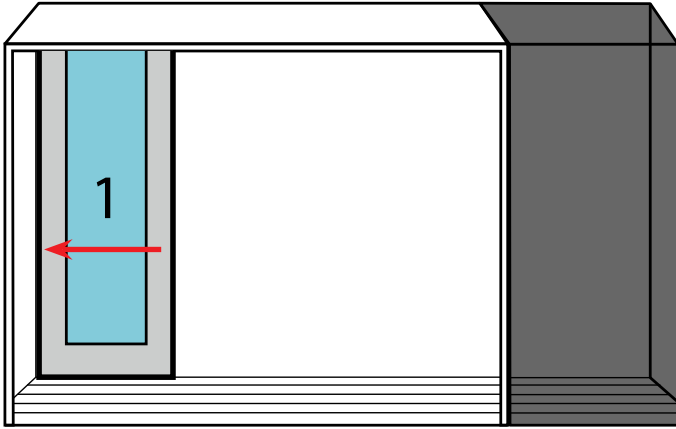

- D. Install second panel, ensuring to position it overlapping the previous panel in order to allow the interlockers to engage. Confirm smooth panel operation and interlockener engagement. Repeat the roller adjustment process to the panel so it is even with the previous panel.

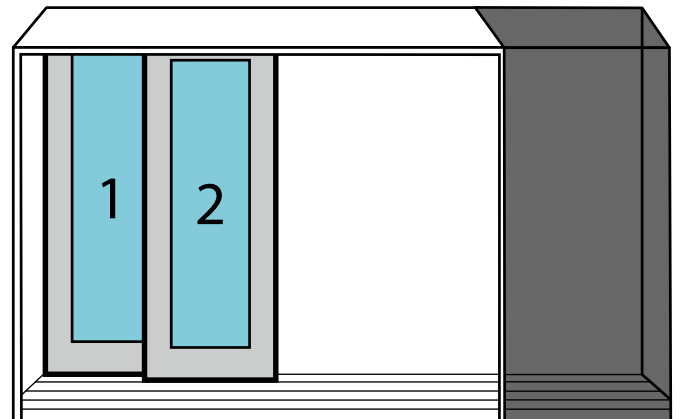

# 7 Panel Installation (continued):

- E. Repeat the panel installation process for all remaining panels, making sure all panels have even reveal and are level.



- F. Slide all panels into the closed position. The fixed panels will be on the exterior-most track, check for proper fit within the frame.

Confirm even reveal and fit at the fixed jamb. Make adjustments as needed.

Check panels at the interlockers for fit.

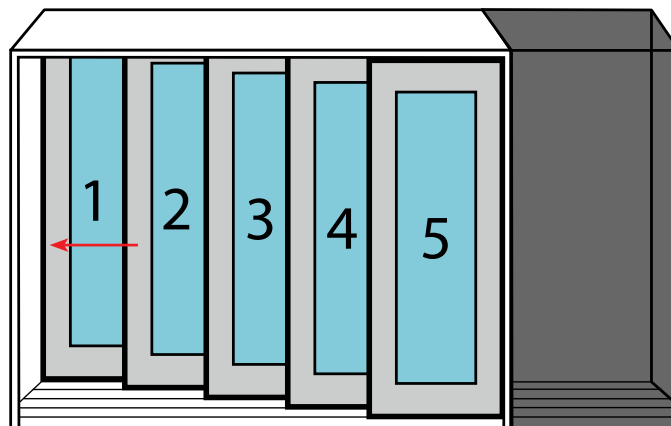

# 7 Panel Installation (continued):

## INSTALL THE COLLECTOR PLATES:

Collector plates are provided in the installation kit.

*Note: Collector plates are only installed on the middle panels, and not panels adjacent to the jambs.*



G. From the interior vent panel, on the trailing edge of the second panel; position the "Z" profile collector plate over the pre-drilled holes and fasten using provided screws.



H. Position the flat profile collector plate on the trailing edge of the next panel over the pilot holes. Install and fasten using provided screws.



I. Continue to attach the remaining flat profile collector plates in the same manner, installing subsequent plates using the pre-drilled holes and provided screws.

# 7 Panel Installation (continued):

- J. Operate the panels to ensure the collector plates engage each panel when sliding the panels to the open position.

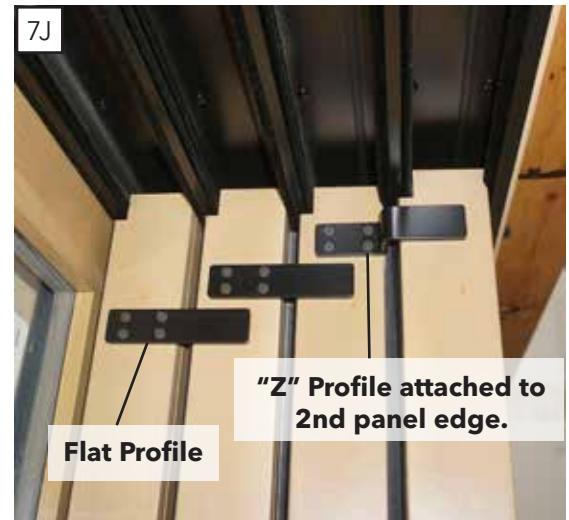

## INSERT THE HEAD FOAM PLUGS:

- K. Remove the foam head plug adhesive release paper.



- L. From the exterior, at the head where the first and second panel meet, insert the foam plug and twist to assure the longest leg sits against the second panel. Firmly press against the head track. Repeat for all middle panels. A head foam plug is not needed on the last panel.

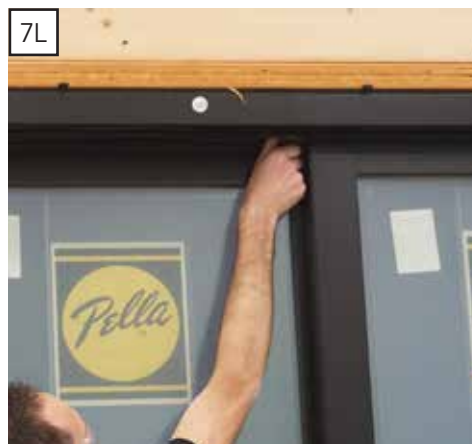

# 8 Pocket Closer & Clad Interlocker Attachment:

A. Attach the wood pocket closer to the pocket side jamb of the first panel which will go into the pocket.

Use a flat blade screwdriver to make sure the weatherstrip pile pad on the pocket closer goes under the panel edge.



B. Position the interlocker against the panel jamb.

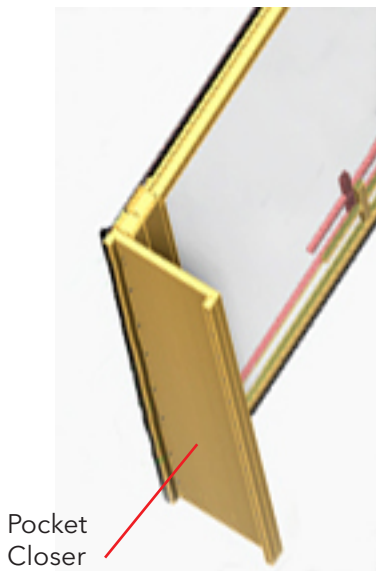

C. Insert a shim under the interlocker to make sure the bottom of the pocket closer aligns with the bottom of the panel.



# 8 Pocket Closer & Clad Interlocker Attachment (continued):

D. Attach the pocket closer to the panel using the provided #12 x 4" lag attachment screws in each pre-drilled hole.



#12 x 4" lag type screw



E. Position the clad interlocker on the exterior edge of the pocket.

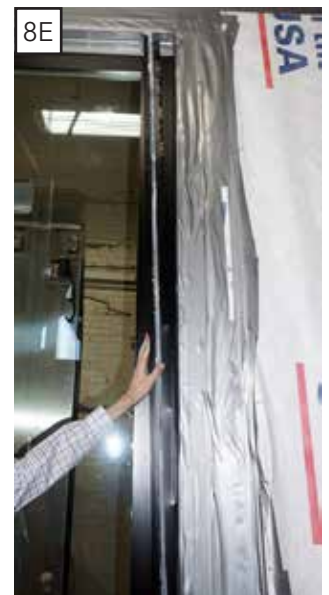



# 8 Pocket Closer & Clad Interlocker Attachment (continued):

F. Attach the interlocker using the provided clad interlocker #8 x 3" attachment screws.



#8 x 3" pan head screw

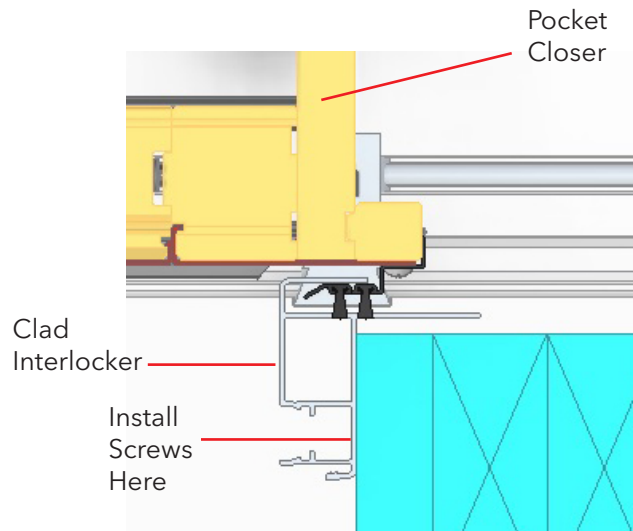

G. Install the installation screw cover and tap in place with a wood block and a rubber mallet along the length of the cover.



# 9 Hardware Installation:

A. Insert the key cylinder into the cylinder housing, aligning with the grooves in the housing. Secure into the housing with cylinder clip.

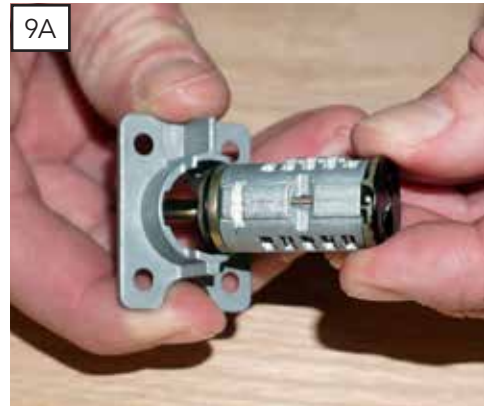

Cylinder clip

B. Position the exterior hardware handle plate so the cylinder hole is up. Insert the assembly, correctly orienting the "UP" arrow. Install the 4 attachment screws.



# 9 Hardware Installation (continued):

C. Keep the thumb turn horizontal with the "V" on the back side of the handle plate upside down (^). Place interior Handle onto interior side of panel.

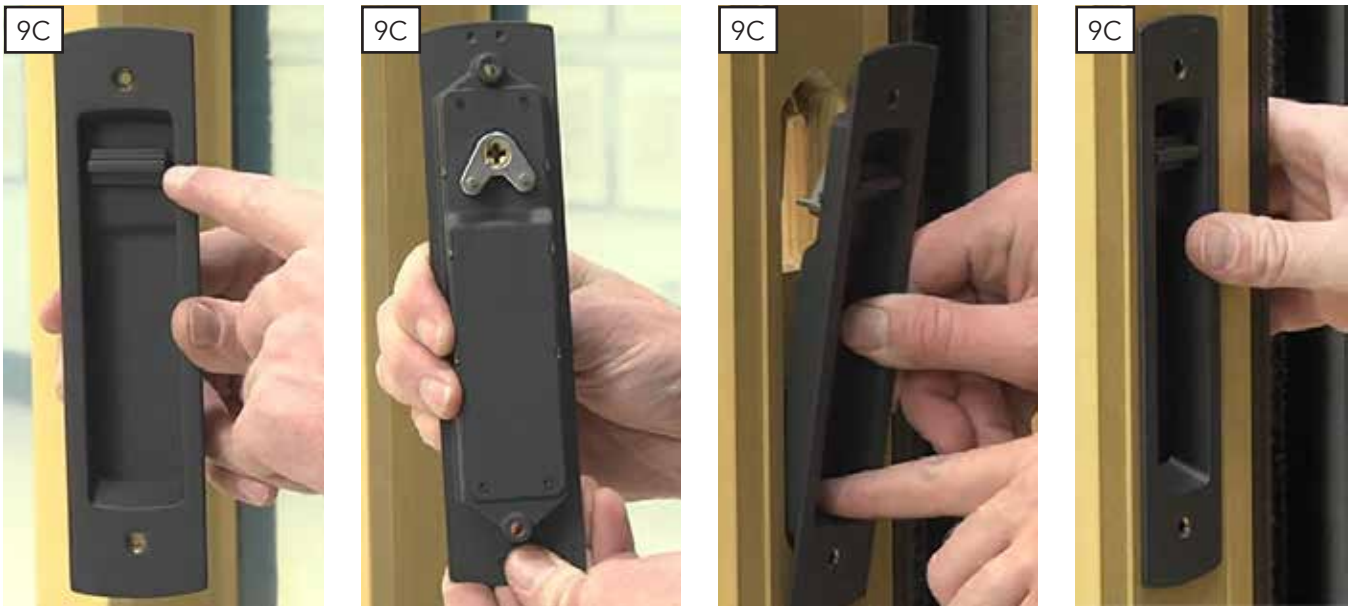

D. From the exterior side of the panel, align the lock handle pin closest to the lock strike with the hole in the lock link already installed in the panel and position the hole on the pin.

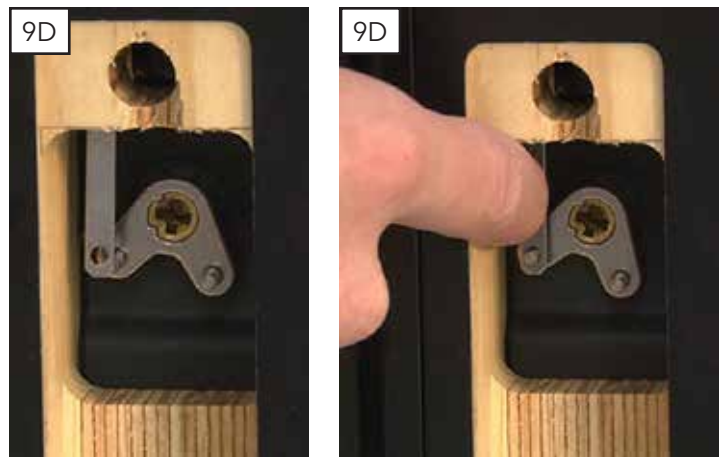

E. Place the retaining washer on a magnetic 1/4" drive socket and install the retaining washer onto the lock handle pin to hold the lock link into place.



**Retaining washer**

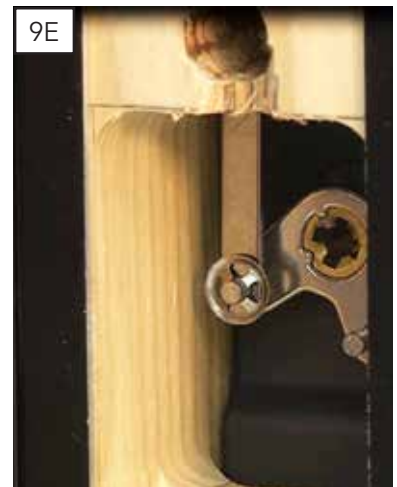
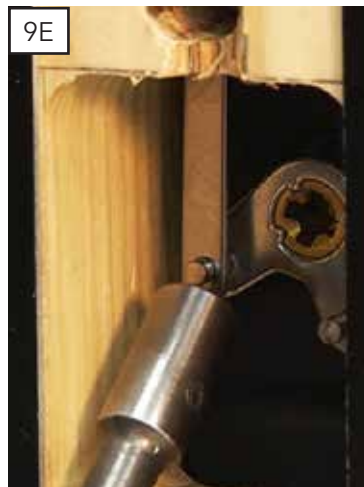

## 9 Hardware Installation (continued):

- F. Install the plastic housing into the exterior handle cavity. With the tail shaft of the exterior handle assembly horizontal, insert exterior handle assembly into the panel and align the key cylinder tail shaft with the interior handle key way.



- G. With both the interior and exterior flush handle plates snug against the panel, install the two handle screws. Check for operation. If thumbturn does not engage easily, remove exterior handle and rotate the cylinder tail shaft 180 degrees and re-install.

Repeat A-G for the lock hardware on dual vent units.



## 9 Hardware Installation (continued):

H. If the door is using a handle set in place of the flush hardware, a bumper must be installed to prevent the handle from contacting the second panel. On the second panel, position the bumper horizontally 1-1/4" down from the top of the panel, and centered 6" from the edge of the panel for a Traditional panel style, or 4" from the edge for a Contemporary panel style. Drill 7/64" pilot holes using the bumper as a drill template. Fasten with provided screws.



# 10 Interior Seal:

**CAUTION: ENSURE USE OF LOW PRESSURE POLYURETHANE WINDOW AND DOOR INSULATING FOAMS AND STRICTLY FOLLOW THE FOAM MANUFACTURER'S RECOMMENDATIONS FOR APPLICATION. USE OF HIGH PRESSURE FOAMS OR IMPROPER APPLICATION OF THE FOAM MAY CAUSE THE DOOR FRAME TO BOW AND HINDER OPERATION.**

A. Apply insulating foam sealant. From the interior, insert the nozzle of the applicator into the space between the door and the rough opening approximately 1" past the edge of the frame (and past the jamb extensions) and apply a 1" deep bead of foam. This will allow room for expansion of the foam and will minimize squeeze out. Apply sealant across interior surface of shims to create a continuous seal. For doors with jamb extensions installed, ensure the foam is placed between the door frame and the rough opening, not between the jamb extension and the rough opening. Follow foam manufacturer's instructions.

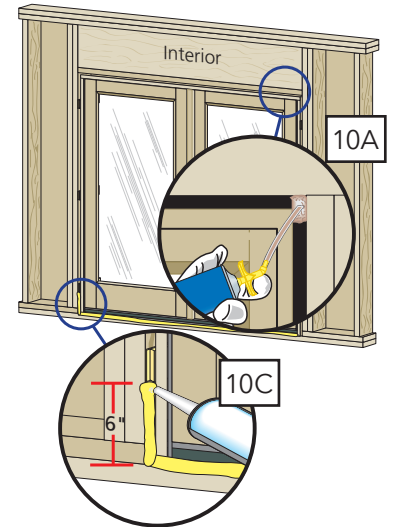

**Note: It may be necessary to squeeze the end of the tube with pliers to be able to insert into the space between the door frame and the rough opening. DO NOT completely fill the space from the back of the fin to the interior face of the opening.**

B. Check the door operation by opening and closing the door.

**Note: If the door does not operate correctly, check to make sure it is still plumb, level, square and that the sides are not bowed. If adjustments are required, remove the foam with a serrated knife. Adjust the shims and reapply the insulating foam sealant.**

C. To ensure a continuous interior seal, apply sealant over the interior surface of any shims or clips interrupting the foam seal.

Backer rod (as necessary) and sealant can be used in place of the low expansion foam to create the interior seal. However, foam has greater insulating properties. Fiberglass batt or similar insulation is not recommended as it can absorb water and does not act as an air seal.

**Note: Use a low odor, paintable sealant such as Pella Window and Door Installation Sealant.**

Re-check door operation after foam installation. Excess foam may be removed with a serrated knife after it cures.

## Concrete Slab Instructions

**Note: Thoroughly clean the slab where sealants will be installed. Instead of installing flashing tape across the bottom of the rough opening, complete the following:**

- Install flashing tape at the bottom 6" of the rough opening jambs.
- Cut (2) 9" pieces of flashing tape as shown.
- Install them overlapping the flashing tape installed in step A by 1".
- Place a 3/8" bead of sealant where the bottom edge of the flashing tape meet the concrete slab.
- When folding building wrap in at the jambs, cut at a 30 degree angle as illustrated.

Follow the applicable installation method pages to complete the installation except seal the door sill directly to the slab

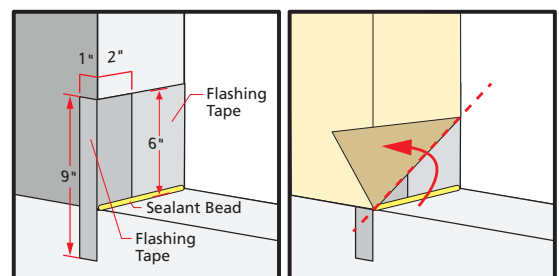
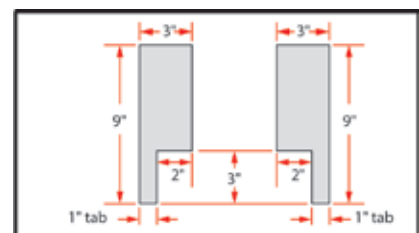

## Interior Finishing:

If products cannot be finished immediately, cover with clear plastic to protect from dirt, damage and moisture. Remove any construction residue before finishing. Sand all wood surfaces lightly with 180 grit or finer sandpaper. DO NOT use steel wool. BE CAREFUL NOT TO SCRATCH THE GLASS. Remove sanding dust.

Pella products must be finished per the below instructions; failure to follow these instructions voids the Limited Warranty.

***Note: To maintain proper product performance do not paint, finish or remove the weather-stripping, mohair dust pads, gaskets or vinyl parts. Air and water leakage will result if these parts are removed. After finishing, allow venting windows and doors to dry completely before closing them.***

Pella Corporation is not responsible for interior paint and stain finish imperfections for any product that is not factory applied by Pella Corporation. Use of inappropriate finishes, solvents, brickwash, or cleaning chemicals will cause adverse reactions with window and door materials and voids Limited Warranty.

For additional information on finishing see the Pella Owner's Manual or go to [www.pella.com](http://www.pella.com).

## EXTERIOR FINISHING:

The exterior panel is protected by aluminum cladding with a Pella EnduraClad® or EnduraClad Plus baked-on factory finish that needs no painting. Clean this surface with mild soap and water. Stubborn stains and deposits may be removed with mineral spirits. DO NOT use abrasives. DO NOT scrape or use tools that might damage the surface.

Use of inappropriate finishes, solvents, brickwash or cleaning chemicals will cause adverse reactions with window and door materials and voids the Limited Warranty.

**IMPORTANT NOTICE:** Because all construction must anticipate some water infiltration, it is important that the wall system be designed and constructed to properly manage moisture. Pella Corporation is not responsible for claims or damages caused by anticipated and unanticipated water infiltration; deficiencies in building design, construction and maintenance; failure to install Pella® products in accordance with Pella installation instructions; or the use of Pella products in wall systems which do not allow for proper management of moisture within the wall systems. The determination of the suitability of all building components, including the use of Pella products, as well as the design and installation of flashing and sealing systems are the responsibility of the Buyer or User, the architect, contractor, installer, or other construction professional and are not the responsibility of Pella.

Pella products should not be used in barrier wall systems which do not allow for proper management of moisture within the wall systems, such as barrier Exterior Insulation and Finish Systems, (EIFS) (also known as synthetic stucco) or other non-water managed systems. Except in the states of California, New Mexico, Arizona, Nevada, Utah, and Colorado, Pella makes no warranty of any kind and assumes no responsibility for Pella windows and doors installed in barrier wall systems. In the states listed above, the installation of Pella products in barrier wall or similar systems must be in accordance with Pella installation instructions. Product modifications that are not approved by Pella Corporation will void the Limited Warranty.