



## IMPORTANT SAFETY AND PRODUCT INFORMATION – WINDOW

**CAUTION:** Many windows in older homes are painted with lead-based paint. Removal of old windows may disturb this paint. Proper precautions must be taken to minimize exposure to dust and debris. Consult state or local authorities and/or go to [www.epa.gov/lead](http://www.epa.gov/lead) for more information.

**WARNING:** To ensure safety and security and help prevent property damage, including possible damage to your window or door, close and lock windows and doors any time they are not being used for venting on a nice day, and particularly during high winds or rain.

### Important Notice

Because all construction must anticipate some water infiltration, it is important that the wall system be designed and constructed to properly manage moisture. Pella Corporation is not responsible for claims or damages caused by anticipated and unanticipated water infiltration; deficiencies in building design, construction and maintenance; failure to install Pella products in accordance with Pella's installation instructions; or the use of Pella products in wall systems which do not allow for proper management of moisture within the wall systems. The determination of the suitability of all building components, including the use of Pella products, as well as the design and installation of flashing and sealing systems are the responsibility of the Buyer or User, the architect, contractor, installer, or other construction professional and are not the responsibility of Pella.

Pella products should not be used in barrier wall systems which do not allow for proper management of moisture within the wall systems, such as barrier Exterior Insulation and Finish Systems (EIFS) (also known as synthetic stucco) or other non-water managed systems. Except in the states of California, New Mexico, Arizona, Nevada, Utah and Colorado, Pella makes no warranty of any kind on and assumes no responsibility for Pella windows and doors installed in barrier wall systems. In the states listed above, the installation of Pella Products in barrier wall or similar systems must be in accordance with Pella's installation instructions. Product modifications that are not approved by Pella Corporation will void the warranty.

### Care and Maintenance

Care and maintenance information is available by contacting your local Pella retailer. This information is also available at [www.pella.com](http://www.pella.com).

### Cleaning Instructions

**GLASS:** Remove any protective film and labels and clean the glass, using a soft, clean, grit-free cloth and mild soap or detergent. Be sure to remove all liquid by wiping dry or use a clean squeegee.

**FACTORY FINISHED PRODUCT:** Pella product that has been prefinished with stain or paint from the factory requires no additional finishing. Clean the surface with mild soap and water.

**PELLA® ALUMINUM CLAD OR IMPERVIA FRAMES:** The interior and exterior frame and sash are protected with a tough factory finish. Clean this surface with mild soap and water. Stubborn stains and deposits may be removed with mineral spirits. DO NOT use abrasives. DO NOT scrape or use tools that might damage the surface.

**ENCOMPASS BY PELLA®, PELLA® 150 SERIES AND PELLA® 250 SERIES AND WINDOWS FRAMES:** The vinyl frame may be cleaned using the same method as the glass. For stubborn dirt, a "non-abrasive" cleaner such as Bon-Ami® or Soft Scrub® may be used. Do not use solvents such as mineral spirits, toluene, xylene, naphtha or muriatic acid as they can dull the finish, soften the vinyl and/or cause failure of the insulated unit seal. Do not use Isopropyl Alcohol on laminated surfaces as it will damage the finish. Keep door tracks clear of dirt and debris. Keep weep holes open and clear of obstructions.

DO NOT use abrasives. DO NOT scrape or use tools that might damage the surface.

**Notice:** DO NOT use inappropriate solvents or brickwash or cleaning chemicals. If you do, permanent damage can result and the product failure, loss or damage would not be covered by the Limited Warranty.

### Interior Finish (Wood Windows)

Paint or finish immediately after installation.

If products cannot be finished immediately, cover with clear plastic to protect from dirt, damage and moisture. Remove any construction residue before finishing. Sand all wood surfaces lightly with 180 grit or finer sandpaper. DO NOT use steel wool. BE CAREFUL NOT TO SCRATCH THE GLASS. Remove sanding dust. Pella products must be finished per the below instructions; failure to follow these instructions voids the Limited Warranty.

**Note:** To maintain proper product performance do not paint, finish or remove the weatherstripping, mohair dust pads, gaskets or vinyl parts. Air and water leakage will result if these parts are removed. After finishing, allow venting windows and doors to dry completely before closing them. If paint, stain or finish gets on the weatherstripping, wipe it off immediately with a damp cloth.

Window Cleaning and Prep Instructions for Unfinished or Primed windows: Dry wipe dust from windows gently. Examine window for possible smudges or fingerprints made from normal handling or construction. To remove smudges, lightly wipe surface with warm water. Scuff sand with light grade sand paper or abrasive pad (220 grit or higher). Rinse surface with warm water. Let window surfaces dry completely before applying finish.

Finish the windows as soon as possible after installation.

- On casement and awnings, it is optional to paint, stain or finish the vertical and horizontal sash edges.
- On single-hungs and double-hungs, do not paint, stain or finish the vertical sash edges, any finish on the vertical sash edges may cause the sash to stick; it is optional to paint, stain or finish the horizontal sash edges.

Pella Corporation is not responsible for interior paint and stain finish imperfections for any product that is not factory-applied by Pella Corporation. For additional information on finishing see the Pella Owner's Manual or go to [www.pella.com](http://www.pella.com).

The use of unapproved finishes, solvents or cleaning chemicals may cause adverse reactions with door materials. Pella will not be responsible for problems caused by the use of unapproved materials. If in doubt, contact your local retailer or representative.







### Exterior Finish of Existing Frame (Pocket Replacement)

It is the responsibility of the homeowner, contractor or installer to ensure any exposed unfinished wood is covered or finished. Possible methods include, however are not limited to, covering with aluminum coil stock or painting.













# PREPARING FOR BRICKMOULD OR FLUSH FLANGE WINDOW INSTALLATION

## YOU WILL NEED TO SUPPLY:

- Moisture resistant shims/spacers 
- Fasteners (see nail fin anchor instructions and tables at the end of this booklet) 
- Closed cell foam backer rod/sealant backer 
- Pella® SmartFlash™ foil backed butyl window and door flashing tape or equivalent 
- Low expansion, low pressure polyurethane insulating window and door foam sealant. **DO NOT** use high pressure or latex foams. 
- Pella Window and Door Installation Sealant or equivalent high quality, multi-purpose sealant 

## TOOLS REQUIRED:

- Tape measure 
- Level 
- Square 
- Hammer 
- Stapler 
- Scissors or utility knife 
- Small flat blade screwdriver 
- Sealant Gun 
- Screw Gun with a Phillips Driver bit 
- Drill with 1/8", 5/32", 3/16" & 3/8" drill bits 
- 1/8" Allen wrench 

**Other construction materials may be required. Read and understand the instructions and inspect the wall conditions before you begin.**

Store windows in upright position, out of direct sunlight.

## INSTALLATION WILL REQUIRE (2) OR MORE PERSONS FOR SAFETY REASONS.

### Preparing for Installation

- Remove plastic wrap and cardboard packaging** from the window. On laminate units, remove protective film from parts. Do not cut checkrail bands (if present) or remove plastic or foam shipping spacers located between the window sash and frame. **DO NOT** open the window until it is securely fastened.
- Inspect the product** for any damage such as cracks, dents or scratches. **DO NOT** install damaged windows.
- Remove screens and hardware** (if necessary). Label them and set aside in a protected area.
 

**Windows with Half Screens:** From the exterior, pull one side of the screen near the shipping clips until the clips disengage from the frame. Rotate the shipping clips toward the exterior of the screen until they snap free from the screen.

Half screens of some vinyl windows can be removed from the interior.
- Pre-Drill Installation holes or install clips** (if necessary). See frame anchor instructions at the end of this booklet."
- Before Installation**, remove dirt and debris from all surfaces of the opening.
- Read the entire instruction before proceeding.**

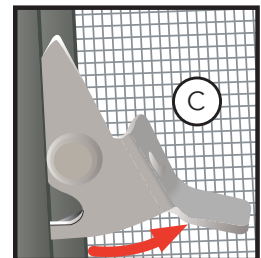
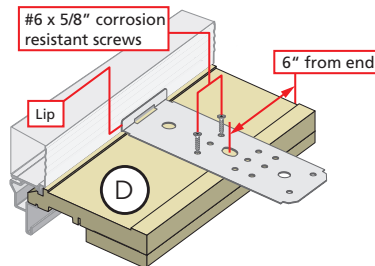
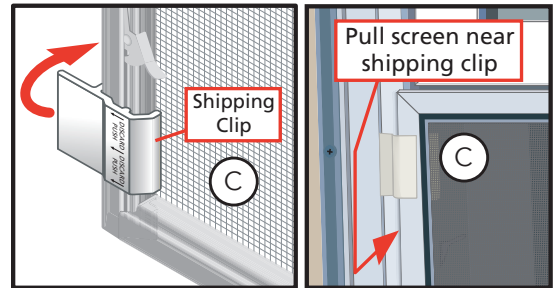

These instructions were developed and tested for use with wall systems designed to manage water. These instructions are not to be used with any other construction methods or window frame types. Installation instructions for use with other construction methods or frame types may be obtained from Pella Corporation, your local Pella retailer or [www.installpella.com](http://www.installpella.com). Building designs, construction methods, building materials, and site conditions unique to your project may require an installation method different from these instructions and/or additional care. Determining the appropriate installation method is the responsibility of you, your architect, or construction professional.



# WOOD BRICKMOULD WINDOW AFTER BUILDING WRAP – FOR USE IN WOOD FRAME WALLS

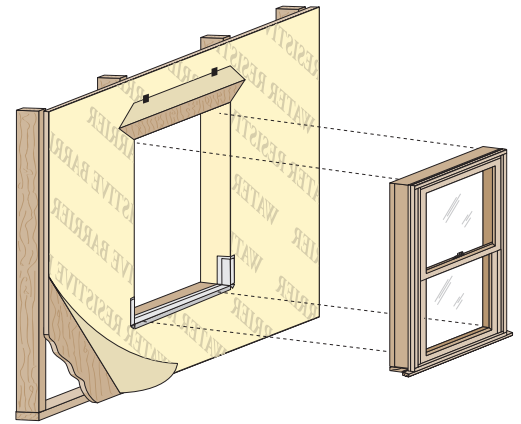
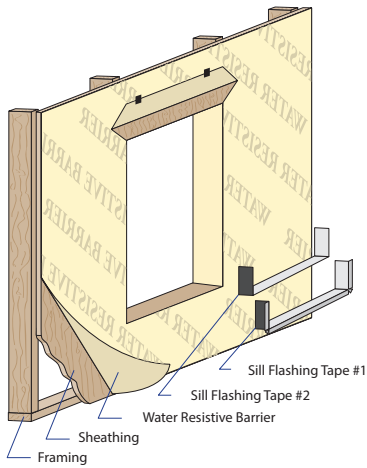

## 1 Prepare the Opening

Refer to the installation preparation section at the beginning of this booklet.

- A. **Confirm the window will fit the opening.** Measure all four sides of the opening to make sure it is 1/2" to 3/4" larger than the window in both width and height including subsill. On larger openings; measure the width and height in several places to ensure the header or studs are not bowed.

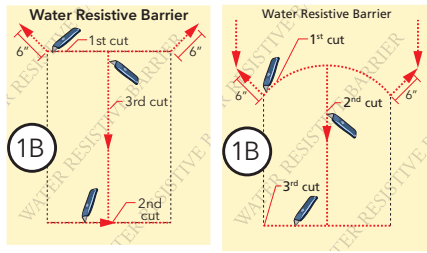

**NOTE: 1-1/2" or more of solid wood blocking is required around the perimeter of the opening.**

Fix any problems with the rough opening before proceeding.

- B. **Cut the building wrap.** Refer to the diagram for other window shapes.
- C. **Fold the building wrap** in at the jambs and staple it in place. Fold the top flap up and temporarily fasten with flashing tape.
- D. **Cut 2 pieces of flashing tape** 12" longer than opening width.
- E. **Apply sill flashing tape #1** at the sill extending 1" to the exterior and 6" up each jamb.
- F. **Cut 1" wide tabs** at each corner by tearing the foil 1/2" each way from corner.
- G. **Apply sill flashing tape #2** overlapping tape #1 by 1" minimum.

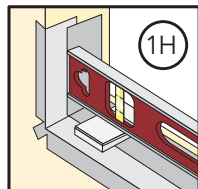
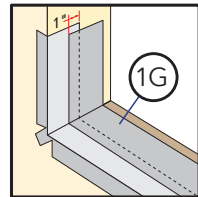
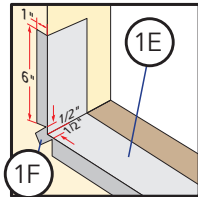
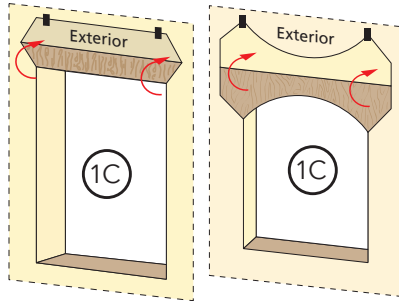

- H. **Install and level sill shims.** Place 1" wide x 1/4" to 3/8" thick shims 1/2" from each side. Keep shims back 1/2" from the interior face of the window. Place additional shims under each mullion and sliding window interlocker.

- I. **Attach shims** to prevent movement after they are level.

**NOTE: Improper placement of shims may result in bowing the bottom of the window.**

## 2 Setting and Fastening the Window

- A. **Apply sealant** to the back of the brickmould or flat casing.
- B. **Insert the window into the opening** by placing the window sill on the sill spacers and tilting the window up. Center the window between jambs.

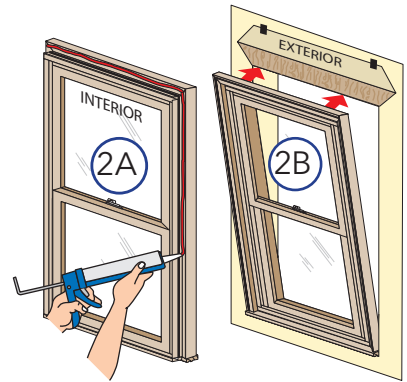

- C. **Level the window across the head.** Adjust the sill shims as necessary.
- D. **Drive 16d galvanized finished nails** at each upper corner through the brickmould and into the wood framing.
- E. **Plumb and square the window** using shims at the locations shown. Adjust shims to plumb and square the window. Keep shims 1/2" short of window frame depth.

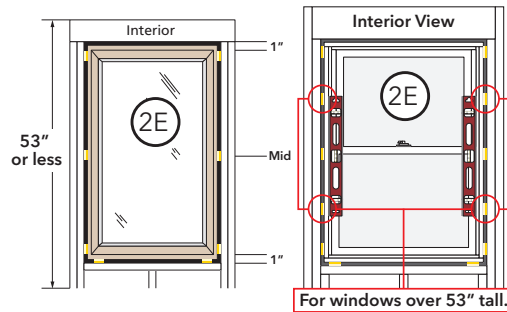
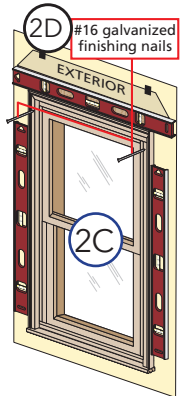

**For windows over 53" tall.**

**NOTE: DO NOT shim above the window or between the sill shims. Additional shims are required at screw locations for large units and combinations. See the anchor instructions at the end of this booklet.**



# WOOD BRICKMOULD WINDOW AFTER BUILDING WRAP – FOR USE IN WOOD FRAME WALLS (CONTINUED)

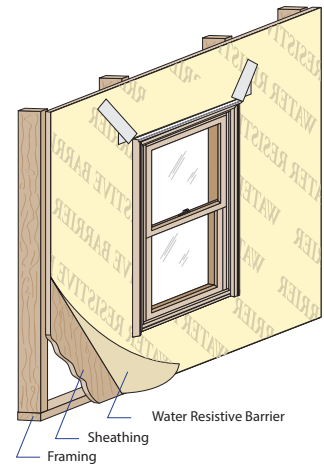
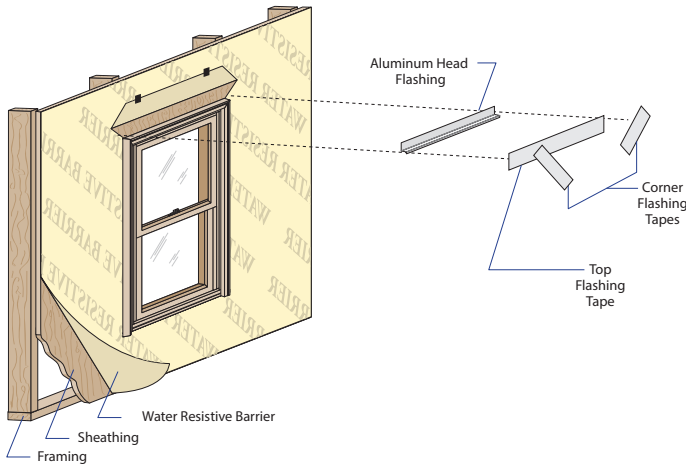

## 2 Setting and Fastening the Window (continued)

### F. Check window operation.

**Vent Awning and Casement:** Refer to applicable hardware instructions. Unlock and open the window to remove the shipping spacers. Open and close the window to test for proper operation.

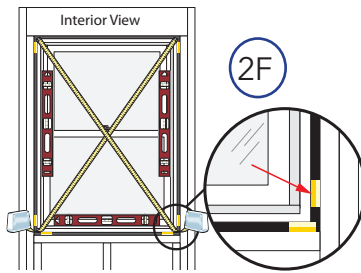

**Double-Hung:** Cut the checkrail bands (if applicable) and remove shipping spacers. Open, close and tilt the sashes to test for proper operation. Check for equal sash to frame reveal from top to bottom.

**NOTE:** Adjust shims to correct any issues with plumb, square, operation or reveal. If necessary, secure window frame to ensure window placement and sash to frame reveal is maintained.

### G. Close and lock the window.

**H. Finish driving #16 galvanized finish nails** through the brickmould. Space nails 4" max. from corners and 10" apart between nails.



### Building Wrap Cutting Patterns for Window Shapes

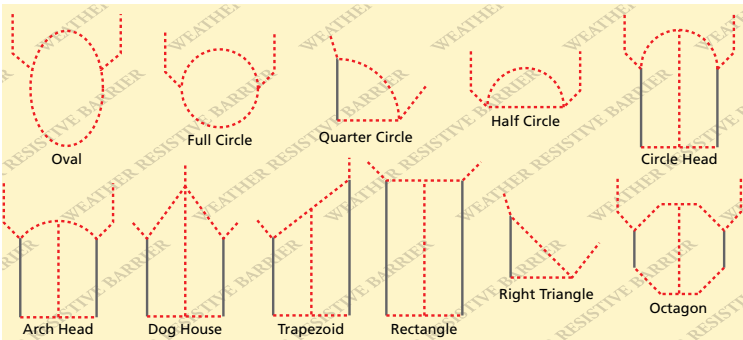

## 3 Integrating with the Building Wrap

- Apply a bead of sealant along the top of the brickmould where it meets the wall. Continue the sealant along the edges of the brickmould to the front corner.
- Install Head Flashing by pressing it into the sealant and securing it to the wall using roofing nails.

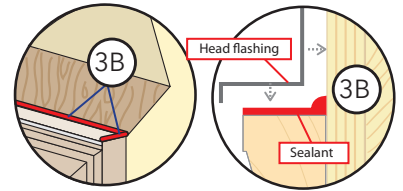

- Cut a piece of flashing tape 4" longer than the brickmould width.

- Apply the flashing tape over the head flashing and onto the sheathing so it extends past the brickmould 2" each side.

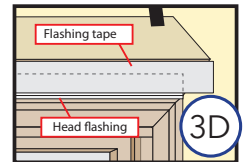

- Fold down top flap of weather resistive barrier.
- Apply flashing tape to top diagonal cuts. Cut pieces of flashing tape at least 1" longer than each diagonal cut. Lap tape 1" past end of cut onto weather barrier. Overlap multiple pieces of tape by 1" when necessary.

**NOTE: PRESS ALL FLASHING TAPE DOWN FIRMLY.**

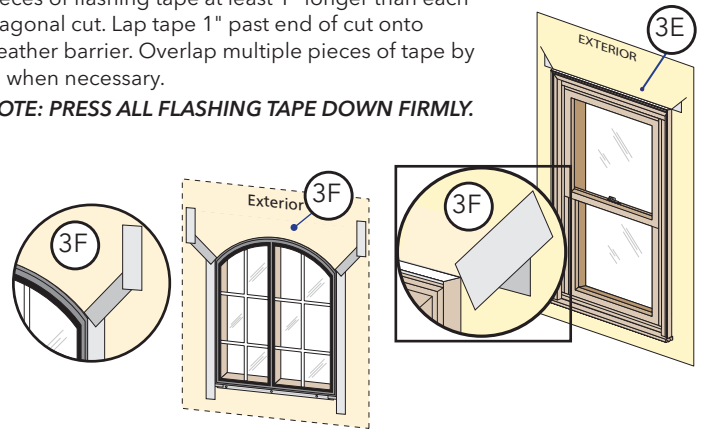

- Install interior sealant. Refer to the interior sealant instructions at the end of this booklet.
- Install exterior sealant. (After wall cladding is installed) Refer to the exterior sealant instructions at the end of this booklet.



# FLUSH FLANGE AND BRICKMOUND FRAME WINDOW ANCHOR INSTRUCTIONS

Note: Standard performance only. Additional anchoring may be required for performance upgrade, impact-resistant products or to comply with local building code requirements.

## Place Frame Screws or Clips at the Locations Indicated

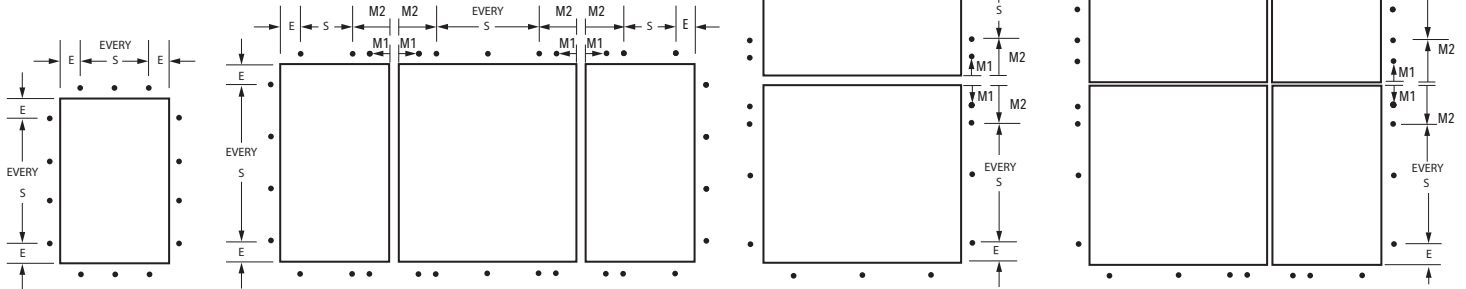

## ARCHITECT SERIES® (850) AND PELLA® LIFESTYLE SERIES WINDOW ANCHOR SPACING INSTRUCTIONS

Product	Edge Spacing (E)	Max. Intermediate Spacing (S)	First Mullion Anchor (M1)	Second Mullion Anchor (M2)	Fastener	Special Notes
					Wood **	
Casement/Awning	6"	16"	3"*	6"	#8x3" Finish Screw	
Double- or Single-Hung	6"	16"	3"*	6"	#8x3" Finish Screw	For windows with integrated Rolscreen® retractable screen, drive jamb screws at each factory pre-punched hole in the jamb liner. Add fasteners as necessary, driving the head past flush of the jamb liner. Avoid Rolscreen components in the head and sill.
Fixed Frame	6"	16"	3"*	6"	#8x3" Finish Screw	
Monumental DH > 54" x 96"	6" (head)	16" (head)	3" *	6" *	#8 x 3" Screw	Remove sashes and jamb liners. Drive 1 screw through each jamb liner support clip (top, bottom, checkrail and center of each sash). Drive 2 additional screws through the frame (or secure clips) 3" above and below the checkrail on each jamb. Drive additional screws through the frame (or secure clips) centered between each jamb liner support clip.

\* M1 anchor required if design pressure exceeds 20 psf.

\*\* For light gauge steel framing, use #10 self-drilling/self-tapping screws; For concrete or masonry, use 3/16" masonry screws with 1-1/4" minimum embedment.

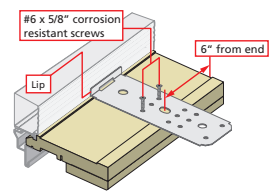
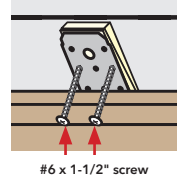

## 1/8" Pilot Hole Locations

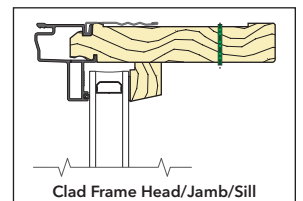
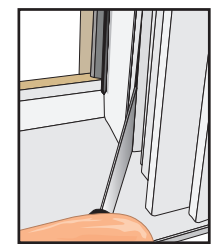
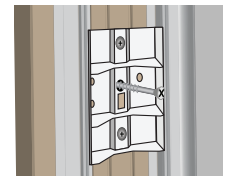
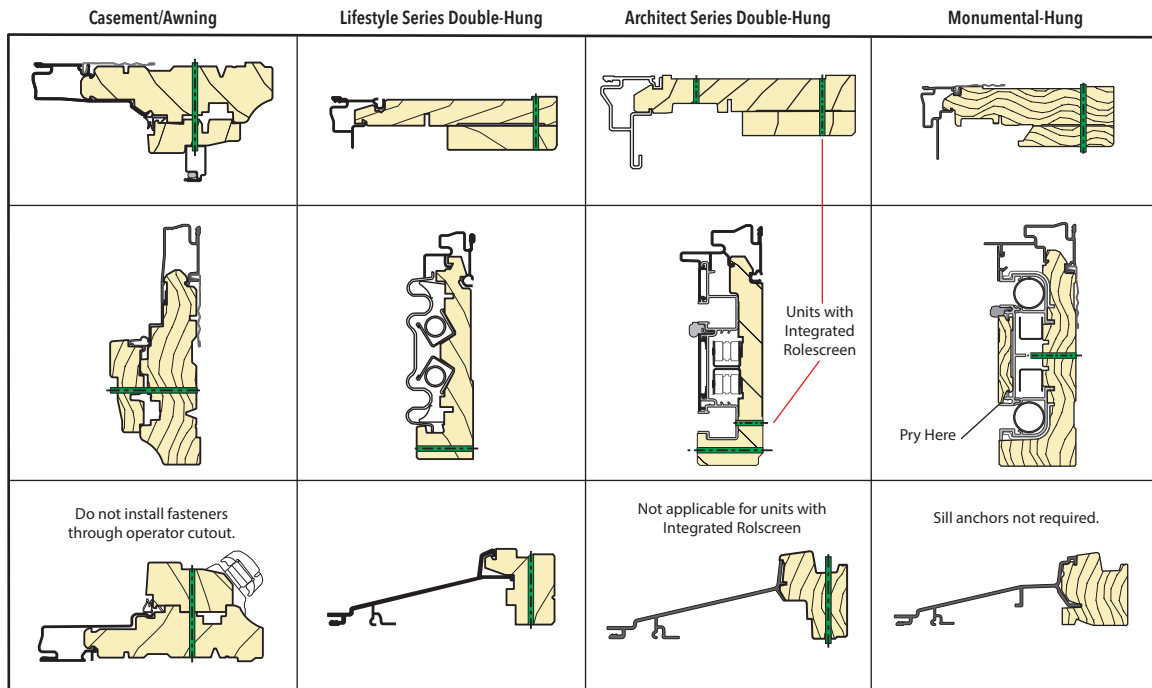



## Interior Sealant Instructions

**CAUTION:** Continuous backer rod (as necessary) and a high quality, low-odor interior sealant such as Pella Window and Door Installation Sealant (or equivalent) is recommended for commercial or high performance installations to create the continuous interior seal. Follow the directions on the cartridge. For standard performance or products with factory applied jamb extensions, use low pressure polyurethane insulating foams. Follow the directions on the can. Do not use high pressure or latex foams. Fiberglass batt or similar insulation is not recommended as it can absorb water and does not act as an air seal.

- A. Insert the nozzle or straw between the rough opening and window frame. This can be done from the interior or exterior.
- B. Place a 1" deep bead of foam approx. 1" from the interior of the frame to allow for expansion. DO NOT fill the entire depth of the rough opening cavity.  
**NOTE:** Apply foam between the frame and rough opening, NOT between jamb extensions and the rough opening.
- C. Re-Check window operation and remove remaining shipping spacers after foam installation. Excess foam may be removed with a serrated knife after it cures.
- D. To ensure a continuous interior seal, apply sealant over or around any shims or clips interrupting the foam seal.

Use sealant instead of foam at all 4 sides on the interior of 1/2" flange vinyl windows installed in masonry construction with pre-cast sills. Add backer rod if the gap exceeds 3/16".

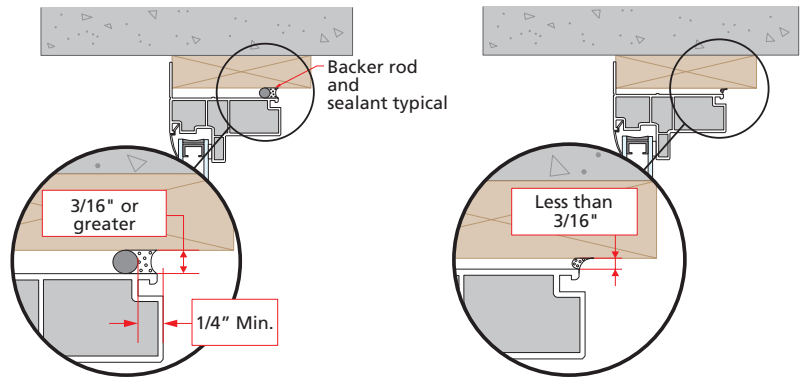
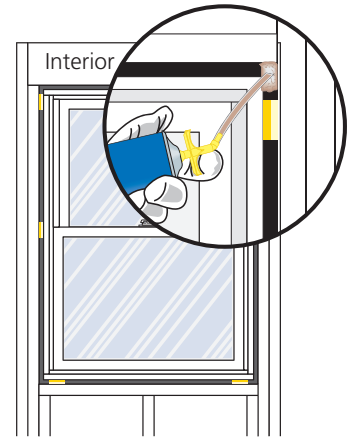

## Exterior Sealant Instructions

**CAUTION:** Use a high quality, multi-purpose exterior sealant such as Pella Window and Door Installation Sealant. Follow the directions on the cartridge.

### Flush Flange Windows

Place a corner bead of sealant on the top, sides and bottom of the window along the edge of the flush flange where it meets the stucco. Leave a 2" gap in the sealant bead at the bottom below the weep hole location in the existing aluminum frame.

### Brickmould Windows

If the space between the new window brickmould and the opening is less than 1/4", go to step (B).

- A. Insert backer rod 3/8" deep in the space around the window. Backer rod adds shape and controls the depth of the sealant line.
- B. Apply a continuous bead of sealant to the entire perimeter of the window. Do not block weep holes or weep hoods with sealant.
- C. Shape, tool and clean excess sealant. When finished, the sealant should be the shape of an hourglass.

