



Product Selection Guide

Size and Performance Data F-FFDS-2

Features and Options..... F-FFDS-3

Glazing Performance

Dual-Pane F-FFDS-4

Dual-Pane Laminated for Sound..... F-FFDS-17

Dual-Pane Impact-Resistant Laminated.....F-FFDS-19

Triple-Pane F-FFDS-21

Grille Types..... F-FFDS-25

Special Size Charts F-FFDS-26

Composite Configurations F-FFDS-27

Impact-Resistant Certifications and Approvals..... F-FFDS-28

Detailed Product Descriptions F-FFDS-29

Unit Sections

Dual-Pane Single Units F-FFDS-31

Dual-Pane Composites F-FFDS-32

Triple-Pane Single Units..... F-FFDS-33

Triple-Pane Composites..... F-FFDS-34

Impact-Resistant Laminated Glass Single Units F-FFDS-35

Document Navigation Tips:

Items listed in the table of contents above are active links that will take you to the corresponding page.

The Pella logo on each page is a link back to this table of contents.

Bookmarks are also included in this PDF document and are available as an additional navigation option.

Supporting documents for this product:

Test Reports:

https://media.pella.com/professional/adm/CertificationReports/Test_Reports_IMP.pdf?utm_source=pdfdoc

CSI Specs (readable using Microsoft Word or other text editing application):

https://media.pella.com/professional/adm/Fiberglass-CSI_Specs/08572_FF.rtf?utm_source=pdfdoc

AIA Masterspec (readable using Microsoft Word or other text editing application):

https://media.pella.com/professional/adm/Fiberglass-CSI_Specs/085413_fl.doc?utm_source=pdfdoc

Detailed Product Description (readable using Microsoft Word or other text editing application):

https://media.pella.com/professional/adm/Fiberglass/F2-FFDS.rtf?utm_source=pdfdoc

CAD cross sections (requires appropriate CAD software to read and use):

https://media.pella.com/professional/adm/Fiberglass/IMP-FF-Detail_D.dwg?utm_source=pdfdoc

3D & BIM (requires appropriate software to read and use):

https://media.pella.com/professional/adm/RevitFiles/Imp-Revit/Window-Fixed-Pella-Impervia-Block_Frame.zip?utm_source=pdfdoc

Sketchup (requires appropriate software to read and use):

https://media.pella.com/professional/adm/Fiberglass/PellaSKP_Impervia_Fixed_Frame.zip?utm_source=pdfdoc

Combination Recommendations:

https://media.pella.com/professional/adm/Fiberglass/F2_Combinations.pdf?utm_source=pdfdoc

Installation Details:

https://media.pella.com/professional/adm/Fiberglass/Pella-Impervia_InstallationDetails.pdf?utm_source=pdfdoc

Microsoft and Microsoft Word are registered trademarks of Microsoft Corp.



Size and Performance Data

	Standard
Sizes	
Special Sizes	●
Performance₁	
Meets or Exceeds AAMA /WDMA Ratings	FW - CW +50 / -55 Hallmark Certified
Air Infiltration (cfm/ft ² of frame @ 1.57 psf wind pressure)	0.05
Water Resistance	7.5 psf
Design Pressure	30 - 50 psf
Products with Impact-Resistant Laminated Glass	FW - LC +50 / -55 Missile C, Windzone 2 Hallmark Certified
Other Performance Criteria	
Forced Entry Resistance Level (Minimum Security Grade) ₂	40

Sound Transmission Class and Outdoor-Indoor Transmission Class

Frame Size Tested ₃	Glazing System				STC Rating	OITC Rating
	Overall Glazing Thickness	Exterior Glass Thickness	Interior Glass Thickness	Third Pane Thickness		
Fixed Frame Direct Set						
47-1/2" x 59-1/2"	1"	3mm	3mm	—	28	23
47-1/2" x 59-1/2"	1"	4mm	4mm	—	30	24
47-1/2" x 59-1/2"	1"	5mm	5mm	—	31	25
47-1/2" x 59-1/2"	1"	6mm	6mm	—	32	27
47-1/2" x 59-1/2"	1"	5mm	3mm	—	31	27
47-1/2" x 59-1/2"	1"	4mm	6mm	—	33	28
47-1/2" x 59-1/2"	1"	4mm	7mm Laminated	—	33	28
47-1/2" x 59-1/2"	1"	5mm	10mm Laminated	—	36	31
47-1/2" x 59-1/2"	1-1/4"	3mm	3mm	3mm	28	22
47-1/2" x 59-1/2"	1-1/4"	4mm	4mm	4mm	30	25
47-1/2" x 59-1/2"	1-1/4"	5mm	5mm	5mm	31	26
47-1/2" x 59-1/2"	1-1/4"	6mm	6mm	6mm	34	28

S = Standard; O = Optional

(1) See Design Data pages in this section for specific product performance class and grade values.

(2) The higher the level, the greater the product's ability to resist forced entry.

(3) ASTM E 1425 defines standard sizes for acoustical testing. Ratings achieved at that size are representative of all sizes of the same configuration.

All sizes and glass types are tested for air/water/structural and impact-resistance.



Impervia® Fixed Frame Windows

Features and Options

	Block Frame
Glazing	
Glazing Type	
Dual-pane Insulating Glass	S
Triple-pane Insulating Glass	O
Insulated Glass Options / Low-E Types	
Clear Insulating Glass (no Low-E coating)	S
Advanced Low-E Insulating Glass	O
SunDefense™ Low-E Insulating Glass	O
SunDefense+ Low-E Insulating Glass	O
AdvancedComfort Low-E Insulating Glass	O
NaturalSun Low-E Insulating Glass	O
NaturalSun+ Low-E Insulating Glass	O
Additional Glass Options	
Annealed Glass	S
Tempered Glass	O
Impact-Resistant Laminated Glass	O
Noise reduction glass (5/3mm, 4/6mm combinations)	O
Noise reduction laminated glass (4/7mm, 5/10mm non-impact)	O
Tinted glass (Bronze, Gray, Green) Advanced Low-E	O
Obscure Glass ¹	O
Spandrel Glass	O
Gas Fill / High Altitude	
Argon	S
High Altitude	O
High Altitude with argon	O
Exterior / Interior Factory Pre-finish Colors	
Powder-Coat White	S
Powder-Coat Brown, Black, Tan or Morning Sky Gray	O
Powder-Coat Dual-color (Brown, Black, Tan or Morning Sky Gray exterior with White interior)	O
Grilles	
Grilles-Between-the-Glass	
Traditional, Prairie, Top Row	O
Applied Grilles	
Equally Divided, Unequally Divided and Top Row	O

S = Standard; O = Optional

(1) Contact your local Pella sales representative for current offering.



Impervia® Fixed Frame Windows

Glazing Performance - Total Unit

Glazing Thickness	Type of Glazing	NFRC Certified Product #	Glass (mm)		Gap Fill	U-Factor	SHGC	VLT	CR	Shaded Areas Meet ENERGY STAR® Performance Criteria in Zones Shown					
			Ext.	Int.						U. S.			Canada		
										Zone	ER	Zone	ER		
			Fixed										N	NC	SC
1"	Clear IG	PEL-N-257-00001-00001	3	3	air	0.46	0.68	0.72	45						
	with grilles-between-the-glass	PEL-N-257-00001-00002				0.46	0.61	0.64	45						
	with applied grilles	PEL-N-257-00001-00005				0.46	0.55	0.57	45						
1"	Clear IG	PEL-N-257-00003-00001	4	4	air	0.45	0.66	0.71	45						
	with grilles-between-the-glass	PEL-N-257-00003-00002				0.45	0.60	0.64	45						
	with applied grilles	PEL-N-257-00003-00005				0.45	0.53	0.57	45						
1"	Clear IG	PEL-N-257-00005-00001	5	5	air	0.45	0.65	0.71	45						
	with grilles-between-the-glass	PEL-N-257-00005-00002				0.45	0.59	0.63	45						
	with applied grilles	PEL-N-257-00005-00005				0.45	0.53	0.56	45						
1"	Clear IG	PEL-N-257-00007-00001	6	6	air	0.45	0.63	0.70	44						
	with grilles-between-the-glass	PEL-N-257-00007-00002				0.45	0.57	0.62	44						
	with applied grilles	PEL-N-257-00007-00005				0.45	0.51	0.56	44						
1"	Advanced Low-E IG	PEL-N-257-00014-00001	3	3	argon	0.27	0.32	0.61	58						
	with grilles-between-the-glass	PEL-N-257-00014-00002				0.27	0.29	0.55	58						
	with applied grilles	PEL-N-257-00014-00005				0.27	0.26	0.49	58						
1"	Advanced Low-E IG	PEL-N-257-00016-00001	4	4	argon	0.27	0.32	0.60	60						
	with grilles-between-the-glass	PEL-N-257-00016-00002				0.27	0.29	0.54	60						
	with applied grilles	PEL-N-257-00016-00005				0.27	0.26	0.48	60						
1"	Advanced Low-E IG	PEL-N-257-00018-00001	5	5	argon	0.27	0.31	0.60	60						
	with grilles-between-the-glass	PEL-N-257-00018-00002				0.27	0.29	0.54	60						
	with applied grilles	PEL-N-257-00018-00005				0.27	0.26	0.48	60						
1"	Advanced Low-E IG	PEL-N-257-00020-00001	6	6	argon	0.26	0.31	0.59	59						
	with grilles-between-the-glass	PEL-N-257-00020-00002				0.26	0.28	0.53	59						
	with applied grilles	PEL-N-257-00020-00005				0.26	0.26	0.47	59						
1"	SunDefense™ IG	PEL-N-257-00044-00001	3	3	argon	0.27	0.24	0.56	59						
	with grilles-between-the-glass	PEL-N-257-00044-00002				0.27	0.22	0.51	59			SC	S		
	with applied grilles	PEL-N-257-00044-00005				0.27	0.20	0.45	59			SC	S		
1"	SunDefense™ IG	PEL-N-257-00046-00001	4	4	argon	0.26	0.24	0.56	61						
	with grilles-between-the-glass	PEL-N-257-00046-00002				0.26	0.22	0.50	61			SC	S		
	with applied grilles	PEL-N-257-00046-00005				0.26	0.20	0.45	61			SC	S		
1"	SunDefense™ IG	PEL-N-257-00048-00001	5	5	argon	0.26	0.24	0.55	60						
	with grilles-between-the-glass	PEL-N-257-00048-00002				0.26	0.22	0.50	60			SC	S		
	with applied grilles	PEL-N-257-00048-00005				0.26	0.20	0.44	60			SC	S		
1"	SunDefense™ IG	PEL-N-257-00050-00001	6	6	argon	0.26	0.24	0.55	59						
	with grilles-between-the-glass	PEL-N-257-00050-00002				0.26	0.22	0.49	59			SC	S		
	with applied grilles	PEL-N-257-00050-00005				0.26	0.20	0.44	59			SC	S		
1"	SunDefense+ IG	PEL-N-257-02456-00001	3	3	argon	0.22	0.23	0.55	50	N	NC	SC	S		
	with grilles-between-the-glass	PEL-N-257-02457-00001				0.22	0.21	0.49	50	N	NC	SC	S		
	with applied grilles	PEL-N-257-02458-00001				0.22	0.19	0.44	50	N	NC	SC	S		
1"	SunDefense+ IG	PEL-N-257-02462-00001	4	4	argon	0.22	0.23	0.55	49	N	NC	SC	S		
	with grilles-between-the-glass	PEL-N-257-02463-00001				0.22	0.21	0.49	49	N	NC	SC	S		
	with applied grilles	PEL-N-257-02464-00001				0.22	0.19	0.44	49	N	NC	SC	S		
1"	SunDefense+ IG	PEL-N-257-02480-00001	5	5	argon	0.22	0.23	0.54	49	N	NC	SC	S		
	with grilles-between-the-glass	PEL-N-257-02481-00001				0.22	0.21	0.49	49	N	NC	SC	S		
	with applied grilles	PEL-N-257-02482-00001				0.22	0.19	0.43	49	N	NC	SC	S		
1"	SunDefense+ IG	PEL-N-257-02486-00001	6	6	argon	0.22	0.23	0.53	48	N	NC	SC	S		
	with grilles-between-the-glass	PEL-N-257-02487-00001				0.22	0.21	0.48	48	N	NC	SC	S		
	with applied grilles	PEL-N-257-02488-00001				0.22	0.19	0.43	48	N	NC	SC	S		

Continued on next page

R-Value = 1/U-Factor
 SHGC = Solar Heat Gain Coefficient
 VLT % = Visible Light Transmission
 CR = Condensation Resistance
 ER = Canadian Energy Rating

U.S. Glazing performance values are calculated based on NFRC 100, NFRC 200 and NFRC 500. ENERGY STAR® values are updated to 2023 (version 7) criteria.

The Canadian values shown are based on the updated ENERGY STAR® 2020 initiative.

For center-glass values, see the Product Performance section.

Visit www.energystar.gov for Energy Star guidelines.

Climate Zones

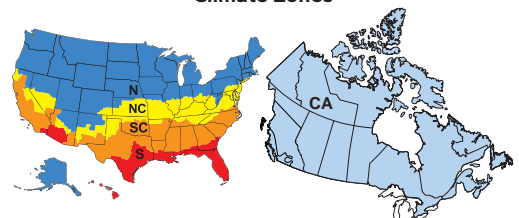



Glazing Thickness	Type of Glazing	NFRC Certified Product #	Glass (mm)		Gap Fill	U-Factor	SHGC	VLT	CR	Shaded Areas Meet ENERGY STAR® Performance Criteria in Zones Shown					
			Ext.	Int.						U. S.				Canada	
										Zone	ER	Zone	Zone		
Fixed										N	NC	SC	S		
1"	AdvancedComfort Low-E IG	PEL-N-257-00068-00001	3	3	argon	0.22	0.32	0.60	49	N	NC				
	with grilles-between-the-glass	PEL-N-257-00068-00002				0.22	0.29	0.54	49	N	NC				
	with applied grilles	PEL-N-257-00068-00005				0.22	0.26	0.48	49	N	NC				
1"	AdvancedComfort Low-E IG	PEL-N-257-00070-00001	4	4	argon	0.22	0.31	0.59	48	N	NC				
	with grilles-between-the-glass	PEL-N-257-00070-00002				0.22	0.28	0.53	48	N	NC				
	with applied grilles	PEL-N-257-00070-00005				0.22	0.25	0.47	48	N	NC				
1"	AdvancedComfort Low-E IG	PEL-N-257-00072-00001	5	5	argon	0.22	0.31	0.58	48	N	NC				
	with grilles-between-the-glass	PEL-N-257-00072-00002				0.22	0.28	0.52	48	N	NC				
	with applied grilles	PEL-N-257-00072-00005				0.22	0.25	0.47	48	N	NC				
1"	AdvancedComfort Low-E IG	PEL-N-257-00074-00001	6	6	argon	0.22	0.30	0.58	47	N	NC				
	with grilles-between-the-glass	PEL-N-257-00074-00002				0.22	0.28	0.52	47	N	NC				
	with applied grilles	PEL-N-257-00074-00005				0.22	0.25	0.46	47	N	NC				
1"	NaturalSun Low-E IG	PEL-N-257-00056-00001	3	3	argon	0.28	0.60	0.69	58					40	CA
	with grilles-between-the-glass	PEL-N-257-00056-00002				0.28	0.54	0.62	58					36	CA
	with applied grilles	PEL-N-257-00056-00005				0.28	0.49	0.55	58						
1"	NaturalSun Low-E IG	PEL-N-257-00058-00001	4	4	argon	0.28	0.59	0.69	60					39	CA
	with grilles-between-the-glass	PEL-N-257-00058-00002				0.28	0.53	0.61	60					36	CA
	with applied grilles	PEL-N-257-00058-00005				0.28	0.47	0.55	60						
1"	NaturalSun Low-E IG	PEL-N-257-00060-00001	5	5	argon	0.28	0.58	0.68	59					38	CA
	with grilles-between-the-glass	PEL-N-257-00060-00002				0.28	0.52	0.61	59					35	CA
	with applied grilles	PEL-N-257-00060-00005				0.28	0.47	0.54	59						
1"	NaturalSun Low-E IG	PEL-N-257-00062-00001	6	6	argon	0.27	0.56	0.67	59					39	CA
	with grilles-between-the-glass	PEL-N-257-00062-00002				0.27	0.51	0.60	59					36	CA
	with applied grilles	PEL-N-257-00062-00005				0.27	0.45	0.54	59						
1"	NaturalSun+ Low-E IG	PEL-N-257-02420-00001	3	3	argon	0.23	0.55	0.67	48	N				43	CA
	with grilles-between-the-glass	PEL-N-257-02421-00001				0.23	0.49	0.61	48	N				39	CA
	with applied grilles	PEL-N-257-02422-00001				0.23	0.44	0.54	48	N				37	CA
1"	NaturalSun+ Low-E IG	PEL-N-257-02426-00001	4	4	argon	0.23	0.53	0.67	48	N				42	CA
	with grilles-between-the-glass	PEL-N-257-02427-00001				0.23	0.48	0.60	48	N				39	CA
	with applied grilles	PEL-N-257-02428-00001				0.23	0.43	0.54	48	N				36	CA
1"	NaturalSun+ Low-E IG	PEL-N-257-02444-00001	5	5	argon	0.23	0.52	0.66	47	N				41	CA
	with grilles-between-the-glass	PEL-N-257-02445-00001				0.23	0.47	0.59	47	N				38	CA
	with applied grilles	PEL-N-257-02446-00001				0.23	0.43	0.53	47	N				36	CA
1"	NaturalSun+ Low-E IG	PEL-N-257-02450-00001	6	6	argon	0.23	0.51	0.65	47	N				41	CA
	with grilles-between-the-glass	PEL-N-257-02451-00001				0.23	0.46	0.59	47	N				38	CA
	with applied grilles	PEL-N-257-02452-00001				0.23	0.41	0.52	47	N				35	CA

R-Value = 1/U-Factor
 SHGC = Solar Heat Gain Coefficient
 VLT % = Visible Light Transmission
 CR = Condensation Resistance
 ER = Canadian Energy Rating

U.S. Glazing performance values are calculated based on NFRC 100, NFRC 200 and NFRC 500. ENERGY STAR® values are updated to 2023 (version 7) criteria.

The Canadian values shown are based on the updated ENERGY STAR® 2020 initiative.

For center-glass values, see the Product Performance section.

Visit www.energystar.gov for Energy Star guidelines.

Climate Zones

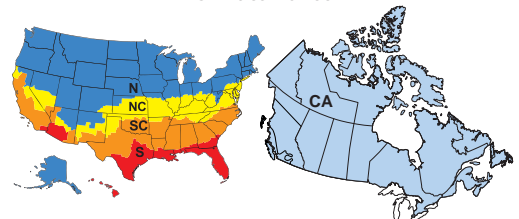



Impervia® Fixed Frame Windows

Glazing Performance - Total Unit

Glazing Thickness	Type of Glazing	NFRC Certified Product #	Glass (mm)		Gap Fill	U-Factor	SHGC	VLT	CR	Shaded Areas Meet ENERGY STAR® Performance Criteria in Zones Shown					
			Ext.	Int.						U. S.			Canada		
										Zone	ER	Zone	ER	Zone	
			Fixed — with Foam Insulation										N	NC	SC
1"	Advanced Low-E IG	PEL-N-257-00206-00001	3	3	argon	0.27	0.32	0.61	59						
	with grilles-between-the-glass	PEL-N-257-00206-00002				0.27	0.29	0.55	59						
	with applied grilles	PEL-N-257-00206-00005				0.27	0.26	0.49	59						
1"	Advanced Low-E IG	PEL-N-257-00208-00001	4	4	argon	0.26	0.32	0.60	61						
	with grilles-between-the-glass	PEL-N-257-00208-00002				0.26	0.29	0.54	61						
	with applied grilles	PEL-N-257-00208-00005				0.26	0.26	0.48	61						
1"	Advanced Low-E IG	PEL-N-257-00210-00001	5	5	argon	0.26	0.31	0.60	60						
	with grilles-between-the-glass	PEL-N-257-00210-00002				0.26	0.29	0.54	60						
	with applied grilles	PEL-N-257-00210-00005				0.26	0.26	0.48	60						
1"	Advanced Low-E IG	PEL-N-257-00212-00001	6	6	argon	0.26	0.31	0.59	59						
	with grilles-between-the-glass	PEL-N-257-00212-00002				0.26	0.28	0.53	59						
	with applied grilles	PEL-N-257-00212-00005				0.26	0.26	0.47	59						
1"	SunDefense IG	PEL-N-257-00236-00001	3	3	argon	0.26	0.24	0.56	59						
	with grilles-between-the-glass	PEL-N-257-00236-00002				0.26	0.22	0.51	59			SC	S		
	with applied grilles	PEL-N-257-00236-00005				0.26	0.20	0.45	59			SC	S		
1"	SunDefense IG	PEL-N-257-00238-00001	4	4	argon	0.26	0.24	0.56	61						
	with grilles-between-the-glass	PEL-N-257-00238-00002				0.26	0.22	0.50	61			SC	S		
	with applied grilles	PEL-N-257-00238-00005				0.26	0.20	0.45	61			SC	S		
1"	SunDefense IG	PEL-N-257-00240-00001	5	5	argon	0.25	0.24	0.55	60		NC				
	with grilles-between-the-glass	PEL-N-257-00240-00002				0.25	0.22	0.50	60		NC	SC	S		
	with applied grilles	PEL-N-257-00240-00005				0.25	0.20	0.44	60		NC	SC	S		
1"	SunDefense IG	PEL-N-257-00242-00001	6	6	argon	0.25	0.24	0.55	60		NC				
	with grilles-between-the-glass	PEL-N-257-00242-00002				0.25	0.22	0.49	60		NC	SC	S		
	with applied grilles	PEL-N-257-00242-00005				0.25	0.20	0.44	60		NC	SC	S		
1"	SunDefense+ IG	PEL-N-257-02564-00001	3	3	argon	0.21	0.23	0.55	50	N	NC	SC	S	27	CA
	with grilles-between-the-glass	PEL-N-257-02565-00001				0.21	0.21	0.49	50	N	NC	SC	S	26	CA
	with applied grilles	PEL-N-257-02566-00001				0.21	0.19	0.44	50	N	NC	SC	S	25	CA
1"	SunDefense+ IG	PEL-N-257-02570-00001	4	4	argon	0.21	0.23	0.55	50	N	NC	SC	S	27	CA
	with grilles-between-the-glass	PEL-N-257-02571-00001				0.21	0.21	0.49	50	N	NC	SC	S	26	CA
	with applied grilles	PEL-N-257-02572-00001				0.21	0.19	0.44	50	N	NC	SC	S	25	CA
1"	SunDefense+ IG	PEL-N-257-02588-00001	5	5	argon	0.21	0.23	0.54	49	N	NC	SC	S	27	CA
	with grilles-between-the-glass	PEL-N-257-02589-00001				0.21	0.21	0.49	49	N	NC	SC	S	26	CA
	with applied grilles	PEL-N-257-02590-00001				0.21	0.19	0.43	49	N	NC	SC	S	25	CA
1"	SunDefense+ IG	PEL-N-257-02594-00001	6	6	argon	0.21	0.23	0.53	48	N	NC	SC	S	27	CA
	with grilles-between-the-glass	PEL-N-257-02595-00001				0.21	0.21	0.48	48	N	NC	SC	S	26	CA
	with applied grilles	PEL-N-257-02596-00001				0.21	0.19	0.43	48	N	NC	SC	S	25	CA
1"	AdvancedComfort Low-E IG	PEL-N-257-00260-00001	3	3	argon	0.22	0.32	0.60	49	N	NC				
	with grilles-between-the-glass	PEL-N-257-00260-00002				0.22	0.29	0.54	49	N	NC				
	with applied grilles	PEL-N-257-00260-00005				0.22	0.26	0.48	49	N	NC				
1"	AdvancedComfort Low-E IG	PEL-N-257-00262-00001	4	4	argon	0.22	0.31	0.59	49	N	NC				
	with grilles-between-the-glass	PEL-N-257-00262-00002				0.22	0.28	0.53	49	N	NC				
	with applied grilles	PEL-N-257-00262-00005				0.22	0.25	0.47	49	N	NC				
1"	AdvancedComfort Low-E IG	PEL-N-257-00264-00001	5	5	argon	0.21	0.31	0.58	48	N	NC			32	CA
	with grilles-between-the-glass	PEL-N-257-00264-00002				0.21	0.28	0.52	48	N	NC			30	CA
	with applied grilles	PEL-N-257-00264-00005				0.21	0.25	0.47	48	N	NC			28	CA
1"	AdvancedComfort Low-E IG	PEL-N-257-00266-00001	6	6	argon	0.21	0.30	0.58	47	N	NC			31	CA
	with grilles-between-the-glass	PEL-N-257-00266-00002				0.21	0.28	0.52	47	N	NC			30	CA
	with applied grilles	PEL-N-257-00266-00005				0.21	0.25	0.46	47	N	NC			28	CA

Continued on next page

R-Value = 1/U-Factor
 SHGC = Solar Heat Gain Coefficient
 VLT % = Visible Light Transmission
 CR = Condensation Resistance
 ER = Canadian Energy Rating

U.S. Glazing performance values are calculated based on NFRC 100, NFRC 200 and NFRC 500. ENERGY STAR® values are updated to 2023 (version 7) criteria.

The Canadian values shown are based on the updated ENERGY STAR® 2020 initiative.

For center-glass values, see the Product Performance section.

Visit www.energystar.gov for Energy Star guidelines.

Climate Zones

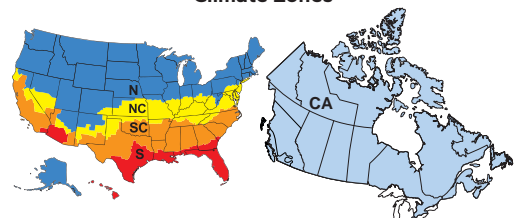



Glazing Thickness	Type of Glazing	NFRC Certified Product #	Glass (mm)		Gap Fill	U-Factor	SHGC	VLT	CR	Shaded Areas Meet ENERGY STAR® Performance Criteria in Zones Shown					
			Ext.	Int.						U. S.				Canada	
										Zone	ER	Zone	Zone		
Fixed — with Foam Insulation										N	NC	SC	S	CA	
1"	NaturalSun Low-E IG	PEL-N-257-00248-00001	3	3	argon	0.28	0.60	0.69	58					40	CA
	with grilles-between-the-glass	PEL-N-257-00248-00002				0.28	0.54	0.62	58					36	CA
	with applied grilles	PEL-N-257-00248-00005				0.28	0.49	0.55	58						
1"	NaturalSun Low-E IG	PEL-N-257-00250-00001	4	4	argon	0.27	0.59	0.69	60					40	CA
	with grilles-between-the-glass	PEL-N-257-00250-00002				0.27	0.53	0.61	60					37	CA
	with applied grilles	PEL-N-257-00250-00005				0.27	0.47	0.55	60						
1"	NaturalSun Low-E IG	PEL-N-257-00252-00001	5	5	argon	0.27	0.58	0.68	59					40	CA
	with grilles-between-the-glass	PEL-N-257-00252-00002				0.27	0.52	0.61	59					36	CA
	with applied grilles	PEL-N-257-00252-00005				0.27	0.47	0.54	59						
1"	NaturalSun Low-E IG	PEL-N-257-00254-00001	6	6	argon	0.27	0.56	0.67	59					39	CA
	with grilles-between-the-glass	PEL-N-257-00254-00002				0.27	0.51	0.60	59					36	CA
	with applied grilles	PEL-N-257-00254-00005				0.27	0.45	0.54	59						
1"	NaturalSun+ Low-E IG	PEL-N-257-02528-00001	3	3	argon	0.23	0.55	0.67	49	N				43	CA
	with grilles-between-the-glass	PEL-N-257-02529-00001				0.23	0.49	0.61	49	N				39	CA
	with applied grilles	PEL-N-257-02530-00001				0.23	0.44	0.54	49	N				37	CA
1"	NaturalSun+ Low-E IG	PEL-N-257-02534-00001	4	4	argon	0.22	0.53	0.67	48	N				43	CA
	with grilles-between-the-glass	PEL-N-257-02535-00001				0.22	0.48	0.60	48	N				40	CA
	with applied grilles	PEL-N-257-02536-00001				0.22	0.43	0.54	48	N				37	CA
1"	NaturalSun+ Low-E IG	PEL-N-257-02552-00001	5	5	argon	0.22	0.52	0.66	48	N				42	CA
	with grilles-between-the-glass	PEL-N-257-02553-00001				0.22	0.47	0.59	48	N				40	CA
	with applied grilles	PEL-N-257-02554-00001				0.22	0.43	0.53	48	N				37	CA
1"	NaturalSun+ Low-E IG	PEL-N-257-02558-00001	6	6	argon	0.22	0.51	0.65	47	N				42	CA
	with grilles-between-the-glass	PEL-N-257-02559-00001				0.22	0.46	0.59	47	N				39	CA
	with applied grilles	PEL-N-257-02560-00001				0.22	0.41	0.52	47	N				36	CA

R-Value = 1/U-Factor
 SHGC = Solar Heat Gain Coefficient
 VLT % = Visible Light Transmission
 CR = Condensation Resistance
 ER = Canadian Energy Rating

U.S. Glazing performance values are calculated based on NFRC 100, NFRC 200 and NFRC 500. ENERGY STAR® values are updated to 2023 (version 7) criteria.

The Canadian values shown are based on the updated ENERGY STAR® 2020 initiative.

For center-glass values, see the Product Performance section.

Visit www.energystar.gov for Energy Star guidelines.

Climate Zones

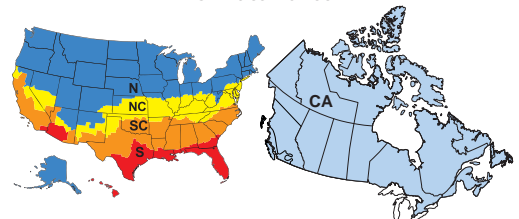



Impervia® Fixed Frame Windows

Glazing Performance - Total Unit

Glazing Thickness	Type of Glazing	NFRC Certified Product #	Glass (mm)		Gap Fill	U-Factor	SHGC	VLT	CR	Shaded Areas Meet ENERGY STAR® Performance Criteria in Zones Shown					
			Ext.	Int.						U. S.			Canada		
										Zone	ER	Zone	ER	Zone	
			Fixed — with High Altitude Glazing										N	NC	SC
1"	(HA) Advanced Low-E IG	PEL-N-257-00013-00001	3	3	air	0.31	0.32	0.61	57						
	with grilles-between-the-glass	PEL-N-257-00013-00002				0.31	0.29	0.55	57						
	with applied grilles	PEL-N-257-00013-00005				0.31	0.27	0.49	57						
1"	(HA) Advanced Low-E IG	PEL-N-257-00015-00001	4	4	air	0.31	0.32	0.60	57						
	with grilles-between-the-glass	PEL-N-257-00015-00002				0.31	0.29	0.54	57						
	with applied grilles	PEL-N-257-00015-00005				0.31	0.26	0.48	57						
1"	(HA) Advanced Low-E IG	PEL-N-257-00017-00001	5	5	air	0.30	0.32	0.60	56						
	with grilles-between-the-glass	PEL-N-257-00017-00002				0.30	0.29	0.54	56						
	with applied grilles	PEL-N-257-00017-00005				0.30	0.26	0.48	56						
1"	(HA) Advanced Low-E IG	PEL-N-257-00019-00001	6	6	air	0.30	0.32	0.59	56						
	with grilles-between-the-glass	PEL-N-257-00019-00002				0.30	0.29	0.53	56						
	with applied grilles	PEL-N-257-00019-00005				0.30	0.26	0.47	56						
1"	(HA) SunDefense IG	PEL-N-257-00043-00001	3	3	air	0.31	0.24	0.56	57						
	with grilles-between-the-glass	PEL-N-257-00043-00002				0.31	0.22	0.51	57					S	
	with applied grilles	PEL-N-257-00043-00005				0.31	0.20	0.45	57					S	
1"	(HA) SunDefense IG	PEL-N-257-00045-00001	4	4	air	0.30	0.24	0.56	57						
	with grilles-between-the-glass	PEL-N-257-00045-00002				0.30	0.22	0.50	57					S	
	with applied grilles	PEL-N-257-00045-00005				0.30	0.20	0.45	57					S	
1"	(HA) SunDefense IG	PEL-N-257-00047-00001	5	5	air	0.30	0.24	0.55	56						
	with grilles-between-the-glass	PEL-N-257-00047-00002				0.30	0.22	0.50	56					S	
	with applied grilles	PEL-N-257-00047-00005				0.30	0.20	0.44	56					S	
1"	(HA) SunDefense IG	PEL-N-257-00049-00001	6	6	air	0.30	0.24	0.55	56						
	with grilles-between-the-glass	PEL-N-257-00049-00002				0.30	0.22	0.49	56					S	
	with applied grilles	PEL-N-257-00049-00005				0.30	0.20	0.44	56					S	
1"	(HA) SunDefense+ IG	PEL-N-257-02453-00001	3	3	air	0.25	0.23	0.55	46		NC	SC	S		
	with grilles-between-the-glass	PEL-N-257-02454-00001				0.25	0.21	0.49	46		NC	SC	S		
	with applied grilles	PEL-N-257-02455-00001				0.25	0.19	0.44	46		NC	SC	S		
1"	(HA) SunDefense+ IG	PEL-N-257-02459-00001	4	4	air	0.25	0.23	0.55	46		NC	SC	S		
	with grilles-between-the-glass	PEL-N-257-02460-00001				0.25	0.21	0.49	46		NC	SC	S		
	with applied grilles	PEL-N-257-02461-00001				0.25	0.19	0.44	46		NC	SC	S		
1"	(HA) SunDefense+ IG	PEL-N-257-02477-00001	5	5	air	0.24	0.23	0.54	45		NC	SC	S		
	with grilles-between-the-glass	PEL-N-257-02478-00001				0.24	0.21	0.49	45		NC	SC	S		
	with applied grilles	PEL-N-257-02479-00001				0.24	0.19	0.43	45		NC	SC	S		
1"	(HA) SunDefense+ IG	PEL-N-257-02483-00001	6	6	air	0.24	0.23	0.53	45		NC	SC	S		
	with grilles-between-the-glass	PEL-N-257-02484-00001				0.24	0.21	0.48	45		NC	SC	S		
	with applied grilles	PEL-N-257-02485-00001				0.24	0.19	0.43	45		NC	SC	S		
1"	(HA) AdvancedComfort Low-E IG	PEL-N-257-00067-00001	3	3	air	0.25	0.32	0.60	45		NC				
	with grilles-between-the-glass	PEL-N-257-00067-00002				0.25	0.29	0.54	45		NC				
	with applied grilles	PEL-N-257-00067-00005				0.25	0.26	0.48	45		NC				
1"	(HA) AdvancedComfort Low-E IG	PEL-N-257-00069-00001	4	4	air	0.25	0.31	0.59	45		NC				
	with grilles-between-the-glass	PEL-N-257-00069-00002				0.25	0.28	0.53	45		NC				
	with applied grilles	PEL-N-257-00069-00005				0.25	0.25	0.47	45		NC				
1"	(HA) AdvancedComfort Low-E IG	PEL-N-257-00071-00001	5	5	air	0.24	0.31	0.58	44		NC				
	with grilles-between-the-glass	PEL-N-257-00071-00002				0.24	0.28	0.52	44		NC				
	with applied grilles	PEL-N-257-00071-00005				0.24	0.25	0.47	44		NC				
1"	(HA) AdvancedComfort Low-E IG	PEL-N-257-00073-00001	6	6	air	0.24	0.31	0.58	44		NC				
	with grilles-between-the-glass	PEL-N-257-00073-00002				0.24	0.28	0.52	44		NC				
	with applied grilles	PEL-N-257-00073-00005				0.24	0.25	0.46	44		NC				

Continued on next page

R-Value = 1/U-Factor
 SHGC = Solar Heat Gain Coefficient
 VLT % = Visible Light Transmission
 CR = Condensation Resistance
 ER = Canadian Energy Rating

U.S. Glazing performance values are calculated based on NFRC 100, NFRC 200 and NFRC 500. ENERGY STAR® values are updated to 2023 (version 7) criteria.

The Canadian values shown are based on the updated ENERGY STAR® 2020 initiative.

For center-glass values, see the Product Performance section.

Visit www.energystar.gov for Energy Star guidelines.

Climate Zones

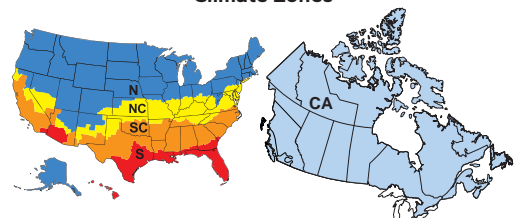



Glazing Thickness	Type of Glazing	NFRC Certified Product #	Glass (mm)		Gap Fill	U-Factor	SHGC	VLT	CR	Shaded Areas Meet ENERGY STAR® Performance Criteria in Zones Shown					
			Ext.	Int.						U. S.				Canada	
										Zone	ER	Zone	Zone		
Fixed — with High Altitude Glazing										N	NC	SC	S	CA	CA
1"	(HA) NaturalSun Low-E IG	PEL-N-257-00055-00001	3	3	air	0.32	0.60	0.69	57					35	CA
	with grilles-between-the-glass	PEL-N-257-00055-00002				0.32	0.54	0.62	57						
	with applied grilles	PEL-N-257-00055-00005				0.32	0.49	0.55	57						
1"	(HA) NaturalSun Low-E IG	PEL-N-257-00057-00001	4	4	air	0.32	0.58	0.69	56						
	with grilles-between-the-glass	PEL-N-257-00057-00002				0.32	0.53	0.61	56						
	with applied grilles	PEL-N-257-00057-00005				0.32	0.47	0.55	56						
1"	(HA) NaturalSun Low-E IG	PEL-N-257-00059-00001	5	5	air	0.31	0.58	0.68	56					35	CA
	with grilles-between-the-glass	PEL-N-257-00059-00002				0.31	0.52	0.61	56						
	with applied grilles	PEL-N-257-00059-00005				0.31	0.47	0.54	56						
1"	(HA) NaturalSun Low-E IG	PEL-N-257-00061-00001	6	6	air	0.31	0.56	0.67	55					34	CA
	with grilles-between-the-glass	PEL-N-257-00061-00002				0.31	0.50	0.60	55						
	with applied grilles	PEL-N-257-00061-00005				0.31	0.45	0.54	55						
1"	(HA) NaturalSun+ Low-E IG	PEL-N-257-02417-00001	3	3	air	0.26	0.55	0.67	39	N				39	CA
	with grilles-between-the-glass	PEL-N-257-02418-00001				0.26	0.49	0.61	39	N				36	CA
	with applied grilles	PEL-N-257-02419-00001				0.26	0.44	0.54	39	N					
1"	(HA) NaturalSun+ Low-E IG	PEL-N-257-02423-00001	4	4	air	0.25	0.53	0.67	45	N				39	CA
	with grilles-between-the-glass	PEL-N-257-02424-00001				0.25	0.48	0.60	45	N				36	CA
	with applied grilles	PEL-N-257-02425-00001				0.25	0.43	0.54	45	N				34	CA
1"	(HA) NaturalSun+ Low-E IG	PEL-N-257-02441-00001	5	5	air	0.25	0.52	0.66	44	N				39	CA
	with grilles-between-the-glass	PEL-N-257-02442-00001				0.25	0.47	0.59	44	N				36	CA
	with applied grilles	PEL-N-257-02443-00001				0.25	0.42	0.53	44	N					
1"	(HA) NaturalSun+ Low-E IG	PEL-N-257-02447-00001	6	6	air	0.25	0.50	0.65	44	N				38	CA
	with grilles-between-the-glass	PEL-N-257-02448-00001				0.25	0.46	0.59	44	N				35	CA
	with applied grilles	PEL-N-257-02449-00001				0.25	0.41	0.52	44	N					

R-Value = 1/U-Factor
 SHGC = Solar Heat Gain Coefficient
 VLT % = Visible Light Transmission
 CR = Condensation Resistance
 ER = Canadian Energy Rating

U.S. Glazing performance values are calculated based on NFRC 100, NFRC 200 and NFRC 500. ENERGY STAR® values are updated to 2023 (version 7) criteria.

The Canadian values shown are based on the updated ENERGY STAR® 2020 initiative.

For center-glass values, see the Product Performance section.

Visit www.energystar.gov for Energy Star guidelines.

Climate Zones

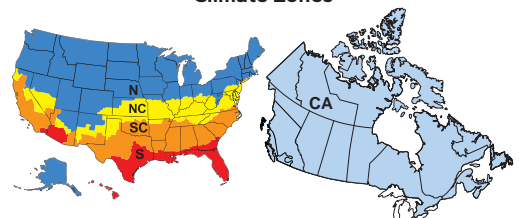



Glazing Thickness	Type of Glazing	NFRC Certified Product #	Glass (mm)		Gap Fill	U-Factor	SHGC	VLT	CR	Shaded Areas Meet ENERGY STAR® Performance Criteria in Zones Shown					
			Ext.	Int.						U. S.			Canada		
										Zone	ER	Zone	ER	Zone	
			Fixed — with High Altitude Glazing and Foam Insulation									N	NC	SC	S
1"	(HA) Advanced Low-E IG	PEL-N-257-00205-00001	3	3	air	0.31	0.32	0.61	57						
	with grilles-between-the-glass	PEL-N-257-00205-00002				0.31	0.29	0.55	57						
	with applied grilles	PEL-N-257-00205-00005				0.31	0.27	0.49	57						
1"	(HA) Advanced Low-E IG	PEL-N-257-00207-00001	4	4	air	0.30	0.32	0.60	57						
	with grilles-between-the-glass	PEL-N-257-00207-00002				0.30	0.29	0.54	57						
	with applied grilles	PEL-N-257-00207-00005				0.30	0.26	0.48	57						
1"	(HA) Advanced Low-E IG	PEL-N-257-00209-00001	5	5	air	0.30	0.32	0.60	56						
	with grilles-between-the-glass	PEL-N-257-00209-00002				0.30	0.29	0.54	56						
	with applied grilles	PEL-N-257-00209-00005				0.30	0.26	0.48	56						
1"	(HA) Advanced Low-E IG	PEL-N-257-00211-00001	6	6	air	0.30	0.32	0.59	56						
	with grilles-between-the-glass	PEL-N-257-00211-00002				0.30	0.29	0.53	56						
	with applied grilles	PEL-N-257-00211-00005				0.30	0.26	0.47	56						
1"	(HA) SunDefense IG	PEL-N-257-00235-00001	3	3	air	0.30	0.24	0.56	58						
	with grilles-between-the-glass	PEL-N-257-00235-00002				0.30	0.22	0.51	58				S		
	with applied grilles	PEL-N-257-00235-00005				0.30	0.20	0.45	58				S		
1"	(HA) SunDefense IG	PEL-N-257-00237-00001	4	4	air	0.30	0.24	0.56	57						
	with grilles-between-the-glass	PEL-N-257-00237-00002				0.30	0.22	0.50	57				S		
	with applied grilles	PEL-N-257-00237-00005				0.30	0.20	0.45	57				S		
1"	(HA) SunDefense IG	PEL-N-257-00239-00001	5	5	air	0.29	0.24	0.55	57						
	with grilles-between-the-glass	PEL-N-257-00239-00002				0.29	0.22	0.50	57				S		
	with applied grilles	PEL-N-257-00239-00005				0.29	0.20	0.44	57				S		
1"	(HA) SunDefense IG	PEL-N-257-00241-00001	6	6	air	0.29	0.24	0.55	56						
	with grilles-between-the-glass	PEL-N-257-00241-00002				0.29	0.22	0.49	56				S		
	with applied grilles	PEL-N-257-00241-00005				0.29	0.20	0.44	56				S		
1"	(HA) SunDefense+ IG	PEL-N-257-02561-00001	3	3	air	0.24	0.23	0.55	47		NC	SC	S		
	with grilles-between-the-glass	PEL-N-257-02562-00001				0.24	0.21	0.49	47		NC	SC	S		
	with applied grilles	PEL-N-257-02563-00001				0.24	0.19	0.44	47		NC	SC	S		
1"	(HA) SunDefense+ IG	PEL-N-257-02567-00001	4	4	air	0.24	0.23	0.55	46		NC	SC	S		
	with grilles-between-the-glass	PEL-N-257-02568-00001				0.24	0.21	0.49	46		NC	SC	S		
	with applied grilles	PEL-N-257-02569-00001				0.24	0.19	0.44	46		NC	SC	S		
1"	(HA) SunDefense+ IG	PEL-N-257-02585-00001	5	5	air	0.24	0.23	0.54	45		NC	SC	S		
	with grilles-between-the-glass	PEL-N-257-02586-00001				0.24	0.21	0.49	45		NC	SC	S		
	with applied grilles	PEL-N-257-02587-00001				0.24	0.19	0.43	45		NC	SC	S		
1"	(HA) SunDefense+ IG	PEL-N-257-02591-00001	6	6	air	0.24	0.23	0.53	45		NC	SC	S		
	with grilles-between-the-glass	PEL-N-257-02592-00001				0.24	0.21	0.48	45		NC	SC	S		
	with applied grilles	PEL-N-257-02593-00001				0.24	0.19	0.43	45		NC	SC	S		
1"	(HA) AdvancedComfort Low-E IG	PEL-N-257-00259-00001	3	3	air	0.24	0.32	0.60	46		NC				
	with grilles-between-the-glass	PEL-N-257-00259-00002				0.24	0.29	0.54	46		NC				
	with applied grilles	PEL-N-257-00259-00005				0.24	0.26	0.48	46		NC				
1"	(HA) AdvancedComfort Low-E IG	PEL-N-257-00261-00001	4	4	air	0.24	0.31	0.59	45		NC				
	with grilles-between-the-glass	PEL-N-257-00261-00002				0.24	0.28	0.53	45		NC				
	with applied grilles	PEL-N-257-00261-00005				0.24	0.25	0.47	45		NC				
1"	(HA) AdvancedComfort Low-E IG	PEL-N-257-00263-00001	5	5	air	0.24	0.31	0.58	45		NC				
	with grilles-between-the-glass	PEL-N-257-00263-00002				0.24	0.28	0.52	45		NC				
	with applied grilles	PEL-N-257-00263-00005				0.24	0.25	0.47	45		NC				
1"	(HA) AdvancedComfort Low-E IG	PEL-N-257-00265-00001	6	6	air	0.24	0.31	0.58	44		NC				
	with grilles-between-the-glass	PEL-N-257-00265-00002				0.24	0.28	0.52	44		NC				
	with applied grilles	PEL-N-257-00265-00005				0.24	0.25	0.46	44		NC				

Continued on next page

R-Value = 1/U-Factor
 SHGC = Solar Heat Gain Coefficient
 VLT % = Visible Light Transmission
 CR = Condensation Resistance
 ER = Canadian Energy Rating

U.S. Glazing performance values are calculated based on NFRC 100, NFRC 200 and NFRC 500. ENERGY STAR® values are updated to 2023 (version 7) criteria.

The Canadian values shown are based on the updated ENERGY STAR® 2020 initiative.

For center-glass values, see the Product Performance section.

Visit www.energystar.gov for Energy Star guidelines.

Climate Zones

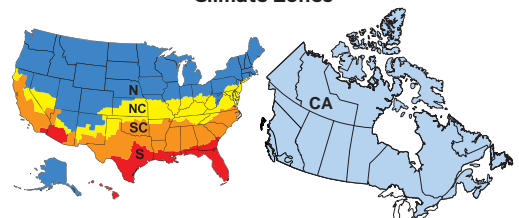



Glazing Thickness	Type of Glazing	NFRC Certified Product #	Glass (mm)		Gap Fill	U-Factor	SHGC	VLT	CR	Shaded Areas Meet ENERGY STAR® Performance Criteria in Zones Shown					
			Ext.	Int.						U. S.				Canada	
										Zone	ER	Zone	Zone		
Fixed — with High Altitude Glazing and Foam Insulation										N	NC	SC	S	CA	CA
1"	(HA) NaturalSun Low-E IG	PEL-N-257-00247-00001	3	3	air	0.31	0.60	0.69	57					36	CA
	with grilles-between-the-glass	PEL-N-257-00247-00002				0.31	0.54	0.62	57						
	with applied grilles	PEL-N-257-00247-00005				0.31	0.49	0.55	57						
1"	(HA) NaturalSun Low-E IG	PEL-N-257-00249-00001	4	4	air	0.31	0.58	0.69	56					35	CA
	with grilles-between-the-glass	PEL-N-257-00249-00002				0.31	0.53	0.61	56						
	with applied grilles	PEL-N-257-00249-00005				0.31	0.47	0.55	56						
1"	(HA) NaturalSun Low-E IG	PEL-N-257-00251-00001	5	5	air	0.31	0.58	0.68	56					35	CA
	with grilles-between-the-glass	PEL-N-257-00251-00002				0.31	0.52	0.61	56						
	with applied grilles	PEL-N-257-00251-00005				0.31	0.47	0.54	56						
1"	(HA) NaturalSun Low-E IG	PEL-N-257-00253-00001	6	6	air	0.30	0.56	0.67	55					35	CA
	with grilles-between-the-glass	PEL-N-257-00253-00002				0.30	0.50	0.60	55						
	with applied grilles	PEL-N-257-00253-00005				0.30	0.45	0.54	55						
1"	(HA) NaturalSun+ Low-E IG	PEL-N-257-02525-00001	3	3	air	0.25	0.55	0.67	39	N				40	CA
	with grilles-between-the-glass	PEL-N-257-02526-00001				0.25	0.49	0.61	39	N				37	CA
	with applied grilles	PEL-N-257-02527-00001				0.25	0.44	0.54	39	N				34	CA
1"	(HA) NaturalSun+ Low-E IG	PEL-N-257-02531-00001	4	4	air	0.25	0.53	0.67	45	N				39	CA
	with grilles-between-the-glass	PEL-N-257-02532-00001				0.25	0.48	0.60	45	N				36	CA
	with applied grilles	PEL-N-257-02533-00001				0.25	0.43	0.54	45	N				34	CA
1"	(HA) NaturalSun+ Low-E IG	PEL-N-257-02549-00001	5	5	air	0.25	0.52	0.66	44	N				39	CA
	with grilles-between-the-glass	PEL-N-257-02550-00001				0.25	0.47	0.59	44	N				36	CA
	with applied grilles	PEL-N-257-02551-00001				0.25	0.42	0.53	44	N					
1"	(HA) NaturalSun+ Low-E IG	PEL-N-257-02555-00001	6	6	air	0.25	0.50	0.65	44	N				38	CA
	with grilles-between-the-glass	PEL-N-257-02556-00001				0.25	0.46	0.59	44	N				35	CA
	with applied grilles	PEL-N-257-02557-00001				0.25	0.41	0.52	44	N					

R-Value = 1/U-Factor
 SHGC = Solar Heat Gain Coefficient
 VLT % = Visible Light Transmission
 CR = Condensation Resistance
 ER = Canadian Energy Rating

U.S. Glazing performance values are calculated based on NFRC 100, NFRC 200 and NFRC 500. ENERGY STAR® values are updated to 2023 (version 7) criteria.

The Canadian values shown are based on the updated ENERGY STAR® 2020 initiative.

For center-glass values, see the Product Performance section.

Visit www.energystar.gov for Energy Star guidelines.

Climate Zones

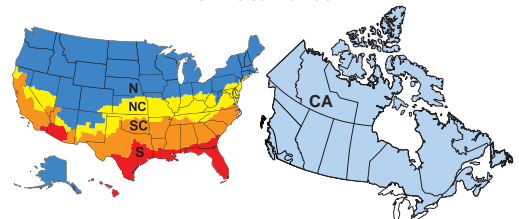



Impervia® Fixed Frame Windows

Glazing Performance - Total Unit

Glazing Thickness	Type of Glazing	NFRC Certified Product #	Glass (mm)		Gap Fill	U-Factor	SHGC	VLT	CR	Shaded Areas Meet ENERGY STAR® Performance Criteria in Zones Shown					
			Ext.	Int.						U. S.			Canada		
										Zone	ER	Zone	ER	Zone	
			Fixed — 5mm/3mm Glazing									N	NC	SC	S
1"	Clear IG	PEL-N-257-00009-00001	5	3	air	0.45	0.66	0.71	45						
	with grilles-between-the-glass	PEL-N-257-00009-00002				0.45	0.59	0.64	45						
	with applied grilles	PEL-N-257-00009-00005				0.45	0.53	0.57	45						
1"	Advanced Low-E IG	PEL-N-257-00034-00001	5	3	argon	0.27	0.32	0.60	61						
	with grilles-between-the-glass	PEL-N-257-00034-00002				0.27	0.29	0.54	61						
	with applied grilles	PEL-N-257-00034-00005				0.27	0.26	0.48	61						
1"	SunDefense™ IG	PEL-N-257-00052-00001	5	3	argon	0.26	0.24	0.56	61						
	with grilles-between-the-glass	PEL-N-257-00052-00002				0.26	0.22	0.50	61			SC	S		
	with applied grilles	PEL-N-257-00052-00005				0.26	0.20	0.45	61			SC	S		
1"	SunDefense+ IG	PEL-N-257-02474-00001	5	3	argon	0.22	0.23	0.55	50	N	NC	SC	S		
	with grilles-between-the-glass	PEL-N-257-02475-00001				0.22	0.21	0.49	50	N	NC	SC	S		
	with applied grilles	PEL-N-257-02476-00001				0.22	0.19	0.44	50	N	NC	SC	S		
1"	AdvancedComfort Low-E IG	PEL-N-257-00076-00001	5	3	argon	0.22	0.31	0.59	49	N	NC				
	with grilles-between-the-glass	PEL-N-257-00076-00002				0.22	0.28	0.53	49	N	NC				
	with applied grilles	PEL-N-257-00076-00005				0.22	0.25	0.47	49	N	NC				
1"	NaturalSun Low-E IG	PEL-N-257-00064-00001	5	3	argon	0.28	0.58	0.68	60					38	CA
	with grilles-between-the-glass	PEL-N-257-00064-00002				0.28	0.52	0.61	60					35	CA
	with applied grilles	PEL-N-257-00064-00005				0.28	0.47	0.55	60						
1"	NaturalSun+ Low-E IG	PEL-N-257-02438-00001	5	3	argon	0.23	0.53	0.67	48	N				42	CA
	with grilles-between-the-glass	PEL-N-257-02439-00001				0.23	0.48	0.60	48	N				39	CA
	with applied grilles	PEL-N-257-02440-00001				0.23	0.43	0.53	48	N				36	CA
Fixed — 5mm/3mm with Foam Insulation															
1"	Advanced Low-E IG	PEL-N-257-00226-00001	5	3	argon	0.26	0.32	0.60	61						
	with grilles-between-the-glass	PEL-N-257-00226-00002				0.26	0.29	0.54	61						
	with applied grilles	PEL-N-257-00226-00005				0.26	0.26	0.48	61						
1"	SunDefense™ IG	PEL-N-257-00244-00001	5	3	argon	0.26	0.24	0.56	61						
	with grilles-between-the-glass	PEL-N-257-00244-00002				0.26	0.22	0.50	61			SC	S		
	with applied grilles	PEL-N-257-00244-00005				0.26	0.20	0.45	61			SC	S		
1"	SunDefense+ IG	PEL-N-257-02582-00001	5	3	argon	0.21	0.23	0.55	50	N	NC	SC	S	27	CA
	with grilles-between-the-glass	PEL-N-257-02583-00001				0.21	0.21	0.49	50	N	NC	SC	S	26	CA
	with applied grilles	PEL-N-257-02584-00001				0.21	0.19	0.44	50	N	NC	SC	S	25	CA
1"	AdvancedComfort Low-E IG	PEL-N-257-00268-00001	5	3	argon	0.22	0.31	0.59	49	N	NC				
	with grilles-between-the-glass	PEL-N-257-00268-00002				0.22	0.28	0.53	49	N	NC				
	with applied grilles	PEL-N-257-00268-00005				0.22	0.25	0.47	49	N	NC				
1"	NaturalSun Low-E IG	PEL-N-257-00256-00001	5	3	argon	0.27	0.58	0.68	61					40	CA
	with grilles-between-the-glass	PEL-N-257-00256-00002				0.27	0.52	0.61	61					36	CA
	with applied grilles	PEL-N-257-00256-00005				0.27	0.47	0.55	61						
1"	NaturalSun+ Low-E IG	PEL-N-257-02546-00001	5	3	argon	0.22	0.53	0.67	48	N				43	CA
	with grilles-between-the-glass	PEL-N-257-02547-00001				0.22	0.48	0.60	48	N				40	CA
	with applied grilles	PEL-N-257-02548-00001				0.22	0.43	0.53	48	N				37	CA

R-Value = 1/U-Factor
 SHGC = Solar Heat Gain Coefficient
 VLT % = Visible Light Transmission
 CR = Condensation Resistance
 ER = Canadian Energy Rating

U.S. Glazing performance values are calculated based on NFRC 100, NFRC 200 and NFRC 500. ENERGY STAR® values are updated to 2023 (version 7) criteria.

The Canadian values shown are based on the updated ENERGY STAR® 2020 initiative.

For center-glass values, see the Product Performance section.

Visit www.energystar.gov for Energy Star guidelines.

Climate Zones

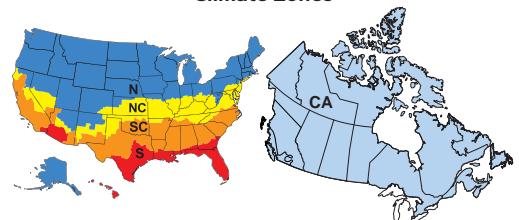



Impervia® Fixed Frame Windows

Glazing Performance - Total Unit

Glazing Thickness	Type of Glazing	NFRC Certified Product #	Glass (mm)		Gap Fill	U-Factor	SHGC	VLT	CR	Shaded Areas Meet ENERGY STAR® Performance Criteria in Zones Shown					
			Ext.	Int.						U. S.				Canada	
										Zone	ER	Zone	CA		
Fixed — 5mm/3mm with High Altitude Glazing										N	NC	SC	S		
1"	(HA) Advanced Low-E IG	PEL-N-257-00033-00001	5	3	air	0.31	0.32	0.60	57						
	with grilles-between-the-glass	PEL-N-257-00033-00002				0.31	0.29	0.54	57						
	with applied grilles	PEL-N-257-00033-00005				0.31	0.26	0.48	57						
1"	(HA) SunDefense IG	PEL-N-257-00051-00001	5	3	air	0.30	0.24	0.56	57						
	with grilles-between-the-glass	PEL-N-257-00051-00002				0.30	0.22	0.50	57				S		
	with applied grilles	PEL-N-257-00051-00005				0.30	0.20	0.45	57				S		
1"	(HA) SunDefense+ IG	PEL-N-257-02471-00001	5	3	air	0.25	0.23	0.55	46		NC	SC	S		
	with grilles-between-the-glass	PEL-N-257-02472-00001				0.25	0.21	0.49	46		NC	SC	S		
	with applied grilles	PEL-N-257-02473-00001				0.25	0.19	0.44	46		NC	SC	S		
1"	(HA) AdvancedComfort Low-E IG	PEL-N-257-00075-00001	5	3	air	0.25	0.31	0.59	45		NC				
	with grilles-between-the-glass	PEL-N-257-00075-00002				0.25	0.28	0.53	45		NC				
	with applied grilles	PEL-N-257-00075-00005				0.25	0.25	0.47	45		NC				
1"	(HA) NaturalSun Low-E IG	PEL-N-257-00063-00001	5	3	air	0.32	0.58	0.68	57						
	with grilles-between-the-glass	PEL-N-257-00063-00002				0.32	0.52	0.61	57						
	with applied grilles	PEL-N-257-00063-00005				0.32	0.47	0.55	57						
1"	(HA) NaturalSun+ Low-E IG	PEL-N-257-02435-00001	5	3	air	0.26	0.53	0.67	45	N				38	CA
	with grilles-between-the-glass	PEL-N-257-02436-00001				0.26	0.47	0.60	45	N				35	CA
	with applied grilles	PEL-N-257-02437-00001				0.26	0.43	0.53	45	N					
Fixed — 5mm/3mm with High Altitude Glazing and Foam Insulation															
1"	(HA) Advanced Low-E IG	PEL-N-257-00225-00001	5	3	air	0.30	0.32	0.60	57						
	with grilles-between-the-glass	PEL-N-257-00225-00002				0.30	0.29	0.54	57						
	with applied grilles	PEL-N-257-00225-00005				0.30	0.26	0.48	57						
1"	(HA) SunDefense IG	PEL-N-257-00243-00001	5	3	air	0.30	0.24	0.56	58						
	with grilles-between-the-glass	PEL-N-257-00243-00002				0.30	0.22	0.50	58				S		
	with applied grilles	PEL-N-257-00243-00005				0.30	0.20	0.45	58				S		
1"	(HA) SunDefense+ IG	PEL-N-257-02579-00001	5	3	air	0.24	0.23	0.55	46		NC	SC	S		
	with grilles-between-the-glass	PEL-N-257-02580-00001				0.24	0.21	0.49	46		NC	SC	S		
	with applied grilles	PEL-N-257-02581-00001				0.24	0.19	0.44	46		NC	SC	S		
1"	(HA) AdvancedComfort Low-E IG	PEL-N-257-00267-00001	5	3	air	0.24	0.31	0.59	45		NC				
	with grilles-between-the-glass	PEL-N-257-00267-00002				0.24	0.28	0.53	45		NC				
	with applied grilles	PEL-N-257-00267-00005				0.24	0.25	0.47	45		NC				
1"	(HA) NaturalSun Low-E IG	PEL-N-257-00255-00001	5	3	air	0.31	0.58	0.68	57					35	CA
	with grilles-between-the-glass	PEL-N-257-00255-00002				0.31	0.52	0.61	57						
	with applied grilles	PEL-N-257-00255-00005				0.31	0.47	0.55	57						
1"	(HA) NaturalSun+ Low-E IG	PEL-N-257-02543-00001	5	3	air	0.25	0.53	0.67	45	N				39	CA
	with grilles-between-the-glass	PEL-N-257-02544-00001				0.25	0.47	0.60	45	N				36	CA
	with applied grilles	PEL-N-257-02545-00001				0.25	0.43	0.53	45	N				34	CA

R-Value = 1/U-Factor
 SHGC = Solar Heat Gain Coefficient
 VLT % = Visible Light Transmission
 CR = Condensation Resistance
 ER = Canadian Energy Rating

U.S. Glazing performance values are calculated based on NFRC 100, NFRC 200 and NFRC 500. ENERGY STAR® values are updated to 2023 (version 7) criteria.

The Canadian values shown are based on the updated ENERGY STAR® 2020 initiative.

For center-glass values, see the Product Performance section.

Visit www.energystar.gov for Energy Star guidelines.

Climate Zones

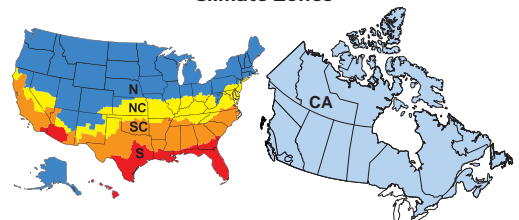



Impervia® Fixed Frame Windows

Glazing Performance - Total Unit

Glazing Thickness	Type of Glazing	NFRC Certified Product #	Glass (mm)		Gap Fill	U-Factor	SHGC	VLT	CR	Shaded Areas Meet ENERGY STAR® Performance Criteria in Zones Shown					
			Ext.	Int.						U. S.				Canada	
										Zone	ER	Zone	CA		
Fixed — 4mm/6mm Glazing										N	NC	SC	S		
1"	Clear IG	PEL-N-257-00011-00001	4	6	air	0.45	0.65	0.70	44						
	with grilles-between-the-glass	PEL-N-257-00011-00002				0.45	0.59	0.63	44						
	with applied grilles	PEL-N-257-00011-00005				0.45	0.53	0.56	44						
1"	Advanced Low-E IG	PEL-N-257-00036-00001	4	6	argon	0.26	0.31	0.60	59						
	with grilles-between-the-glass	PEL-N-257-00036-00002				0.26	0.29	0.54	59						
	with applied grilles	PEL-N-257-00036-00005				0.26	0.26	0.48	59						
1"	SunDefense™ IG	PEL-N-257-00054-00001	4	6	argon	0.26	0.24	0.55	60						
	with grilles-between-the-glass	PEL-N-257-00054-00002				0.26	0.22	0.50	60			SC	S		
	with applied grilles	PEL-N-257-00054-00005				0.26	0.20	0.44	60			SC	S		
1"	SunDefense+ IG	PEL-N-257-02468-00001	4	6	argon	0.22	0.23	0.54	48	N	NC	SC	S		
	with grilles-between-the-glass	PEL-N-257-02469-00001				0.22	0.21	0.49	48	N	NC	SC	S		
	with applied grilles	PEL-N-257-02470-00001				0.22	0.19	0.43	48	N	NC	SC	S		
1"	AdvancedComfort Low-E IG	PEL-N-257-00078-00001	4	6	argon	0.22	0.31	0.58	48	N	NC				
	with grilles-between-the-glass	PEL-N-257-00078-00002				0.22	0.28	0.52	48	N	NC				
	with applied grilles	PEL-N-257-00078-00005				0.22	0.25	0.47	48	N	NC				
1"	NaturalSun Low-E IG	PEL-N-257-00066-00001	4	6	argon	0.27	0.58	0.68	59					40	CA
	with grilles-between-the-glass	PEL-N-257-00066-00002				0.27	0.53	0.61	59					37	CA
	with applied grilles	PEL-N-257-00066-00005				0.27	0.47	0.54	59						
1"	NaturalSun+ Low-E IG	PEL-N-257-02432-00001	4	6	argon	0.23	0.53	0.66	47	N				42	CA
	with grilles-between-the-glass	PEL-N-257-02433-00001				0.23	0.48	0.59	47	N				39	CA
	with applied grilles	PEL-N-257-02434-00001				0.23	0.43	0.53	47	N				36	CA
Fixed — 4mm/6mm with Foam Insulation															
1"	Advanced Low-E IG	PEL-N-257-00228-00001	4	6	argon	0.26	0.31	0.60	60						
	with grilles-between-the-glass	PEL-N-257-00228-00002				0.26	0.29	0.54	60						
	with applied grilles	PEL-N-257-00228-00005				0.26	0.26	0.48	60						
1"	SunDefense™ IG	PEL-N-257-00246-00001	4	6	argon	0.25	0.24	0.55	60		NC				
	with grilles-between-the-glass	PEL-N-257-00246-00002				0.25	0.22	0.50	60		NC	SC	S		
	with applied grilles	PEL-N-257-00246-00005				0.25	0.20	0.44	60		NC	SC	S		
1"	SunDefense+ IG	PEL-N-257-02576-00001	4	6	argon	0.21	0.23	0.54	49	N	NC	SC	S	27	CA
	with grilles-between-the-glass	PEL-N-257-02577-00001				0.21	0.21	0.49	49	N	NC	SC	S	26	CA
	with applied grilles	PEL-N-257-02578-00001				0.21	0.19	0.43	49	N	NC	SC	S	25	CA
1"	AdvancedComfort Low-E IG	PEL-N-257-00270-00001	4	6	argon	0.21	0.31	0.58	48	N	NC			32	CA
	with grilles-between-the-glass	PEL-N-257-00270-00002				0.21	0.28	0.52	48	N	NC			30	CA
	with applied grilles	PEL-N-257-00270-00005				0.21	0.25	0.47	48	N	NC			28	CA
1"	NaturalSun Low-E IG	PEL-N-257-00258-00001	4	6	argon	0.27	0.58	0.68	59					40	CA
	with grilles-between-the-glass	PEL-N-257-00258-00002				0.27	0.53	0.61	59					37	CA
	with applied grilles	PEL-N-257-00258-00005				0.27	0.47	0.54	59						
1"	NaturalSun+ Low-E IG	PEL-N-257-02540-00001	4	6	argon	0.22	0.53	0.66	48	N				43	CA
	with grilles-between-the-glass	PEL-N-257-02541-00001				0.22	0.48	0.59	48	N				40	CA
	with applied grilles	PEL-N-257-02542-00001				0.22	0.43	0.53	48	N				37	CA

R-Value = 1/U-Factor
 SHGC = Solar Heat Gain Coefficient
 VLT % = Visible Light Transmission
 CR = Condensation Resistance
 ER = Canadian Energy Rating

U.S. Glazing performance values are calculated based on NFRC 100, NFRC 200 and NFRC 500. ENERGY STAR® values are updated to 2023 (version 7) criteria.

The Canadian values shown are based on the updated ENERGY STAR® 2020 initiative.

For center-glass values, see the Product Performance section.

Visit www.energystar.gov for Energy Star guidelines.

Climate Zones

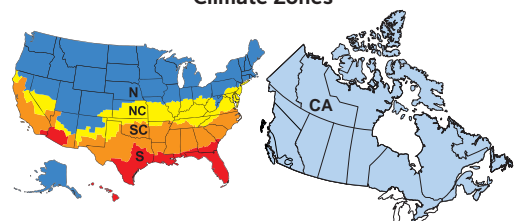



Impervia® Fixed Frame Windows

Glazing Performance - Total Unit

Glazing Thickness	Type of Glazing	NFRC Certified Product #	Glass (mm)		Gap Fill	U-Factor	SHGC	VLT	CR	Shaded Areas Meet ENERGY STAR® Performance Criteria in Zones Shown					
			Ext.	Int.						U. S.				Canada	
										Zone	NC	SC	S	ER	Zone
Fixed — 4mm/6mm with High Altitude Glazing										N	NC	SC	S		CA
1"	(HA) Advanced Low-E IG	PEL-N-257-00035-00001	4	6	air	0.30	0.32	0.60	56						
	with grilles-between-the-glass	PEL-N-257-00035-00002				0.30	0.29	0.54	56						
	with applied grilles	PEL-N-257-00035-00005				0.30	0.26	0.48	56						
1"	(HA) SunDefense IG	PEL-N-257-00053-00001	4	6	air	0.30	0.24	0.55	56						
	with grilles-between-the-glass	PEL-N-257-00053-00002				0.30	0.22	0.50	56					S	
	with applied grilles	PEL-N-257-00053-00005				0.30	0.20	0.44	56					S	
1"	(HA) SunDefense IG	PEL-N-257-02465-00001	4	6	air	0.24	0.23	0.54	45		NC	SC	S		
	with grilles-between-the-glass	PEL-N-257-02466-00001				0.24	0.21	0.49	45		NC	SC	S		
	with applied grilles	PEL-N-257-02467-00001				0.24	0.19	0.43	45		NC	SC	S		
1"	(HA) AdvancedComfort Low-E IG	PEL-N-257-00077-00001	4	6	air	0.24	0.31	0.58	44		NC				
	with grilles-between-the-glass	PEL-N-257-00077-00002				0.24	0.28	0.52	44		NC				
	with applied grilles	PEL-N-257-00077-00005				0.24	0.25	0.47	44		NC				
1"	(HA) NaturalSun Low-E IG	PEL-N-257-00065-00001	4	6	air	0.31	0.58	0.68	55						35 CA
	with grilles-between-the-glass	PEL-N-257-00065-00002				0.31	0.52	0.61	55						
	with applied grilles	PEL-N-257-00065-00005				0.31	0.47	0.54	55						
1"	(HA) NaturalSun Low-E IG	PEL-N-257-02429-00001	4	6	air	0.25	0.52	0.66	44	N					39 CA
	with grilles-between-the-glass	PEL-N-257-02430-00001				0.25	0.47	0.59	44	N					36 CA
	with applied grilles	PEL-N-257-02431-00001				0.25	0.43	0.53	44	N					34 CA
Fixed — 4mm/6mm with High Altitude Glazing and Foam Insulation															
1"	(HA) Advanced Low-E IG	PEL-N-257-00227-00001	4	6	air	0.30	0.32	0.60	56						
	with grilles-between-the-glass	PEL-N-257-00227-00002				0.30	0.29	0.54	56						
	with applied grilles	PEL-N-257-00227-00005				0.30	0.26	0.48	56						
1"	(HA) SunDefense IG	PEL-N-257-00245-00001	4	6	air	0.29	0.24	0.55	57						
	with grilles-between-the-glass	PEL-N-257-00245-00002				0.29	0.22	0.50	57					S	
	with applied grilles	PEL-N-257-00245-00005				0.29	0.20	0.44	57					S	
1"	(HA) SunDefense IG	PEL-N-257-02573-00001	4	6	air	0.24	0.23	0.54	45		NC	SC	S		
	with grilles-between-the-glass	PEL-N-257-02574-00001				0.24	0.21	0.49	45		NC	SC	S		
	with applied grilles	PEL-N-257-02575-00001				0.24	0.19	0.43	45		NC	SC	S		
1"	(HA) AdvancedComfort Low-E IG	PEL-N-257-00269-00001	4	6	air	0.24	0.31	0.58	44		NC				
	with grilles-between-the-glass	PEL-N-257-00269-00002				0.24	0.28	0.52	44		NC				
	with applied grilles	PEL-N-257-00269-00005				0.24	0.25	0.47	44		NC				
1"	(HA) NaturalSun Low-E IG	PEL-N-257-00257-00001	4	6	air	0.31	0.58	0.68	56						35 CA
	with grilles-between-the-glass	PEL-N-257-00257-00002				0.31	0.52	0.61	56						
	with applied grilles	PEL-N-257-00257-00005				0.31	0.47	0.54	56						
1"	(HA) NaturalSun Low-E IG	PEL-N-257-02537-00001	4	6	air	0.25	0.52	0.66	44	N					39 CA
	with grilles-between-the-glass	PEL-N-257-02538-00001				0.25	0.47	0.59	44	N					36 CA
	with applied grilles	PEL-N-257-02539-00001				0.25	0.43	0.53	44	N					34 CA

R-Value = 1/U-Factor
 SHGC = Solar Heat Gain Coefficient
 VLT % = Visible Light Transmission
 CR = Condensation Resistance
 ER = Canadian Energy Rating

U.S. Glazing performance values are calculated based on NFRC 100, NFRC 200 and NFRC 500. ENERGY STAR® values are updated to 2023 (version 7) criteria.

The Canadian values shown are based on the updated ENERGY STAR® 2020 initiative.

For center-glass values, see the Product Performance section.

Visit www.energystar.gov for Energy Star guidelines.

Climate Zones

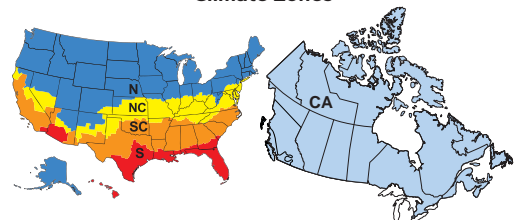



Impervia® Fixed Frame Windows

Glazing Performance - Total Unit

Glazing Thickness	Type of Glazing	NFRC Certified Product #	Glass (mm)		Gap Fill	U-Factor	SHGC	VLT	CR	Shaded Areas Meet ENERGY STAR® Performance Criteria in Zones Shown					
			Ext.	Int.						U. S.				Canada	
										Zone	ER	Zone	CA		
Fixed — Tinted Glazing										N	NC	SC	S		
1"	Bronze Advanced Low-E IG	PEL-N-257-00038-00001	5	3	argon	0.27	0.28	0.39	61						
	with grilles-between-the-glass	PEL-N-257-00038-00002				0.27	0.25	0.35	61						
	with applied grilles	PEL-N-257-00038-00005				0.27	0.23	0.32	61			SC	S		
1"	Gray Advanced Low-E IG	PEL-N-257-00040-00001	5	3	argon	0.27	0.26	0.34	61						
	with grilles-between-the-glass	PEL-N-257-00040-00002				0.27	0.24	0.30	61						
	with applied grilles	PEL-N-257-00040-00005				0.27	0.21	0.27	61			SC	S		
1"	Green Advanced Low-E IG	PEL-N-257-00042-00001	5	3	argon	0.27	0.32	0.53	61						
	with grilles-between-the-glass	PEL-N-257-00042-00002				0.27	0.29	0.48	61						
	with applied grilles	PEL-N-257-00042-00005				0.27	0.26	0.43	61						
Fixed — Tinted Glazing with Foam Insulation															
1"	Bronze Advanced Low-E IG	PEL-N-257-00230-00001	5	3	argon	0.26	0.28	0.39	61						
	with grilles-between-the-glass	PEL-N-257-00230-00002				0.26	0.25	0.35	61						
	with applied grilles	PEL-N-257-00230-00005				0.26	0.23	0.32	61			SC	S		
1"	Gray Advanced Low-E IG	PEL-N-257-00232-00001	5	3	argon	0.26	0.26	0.34	61						
	with grilles-between-the-glass	PEL-N-257-00232-00002				0.26	0.24	0.30	61						
	with applied grilles	PEL-N-257-00232-00005				0.26	0.21	0.27	61			SC	S		
1"	Green Advanced Low-E IG	PEL-N-257-00234-00001	5	3	argon	0.26	0.32	0.53	61						
	with grilles-between-the-glass	PEL-N-257-00234-00002				0.26	0.29	0.48	61						
	with applied grilles	PEL-N-257-00234-00005				0.26	0.26	0.43	61						
Fixed — Tinted Glazing with High Altitude Glazing															
1"	Bronze Advanced Low-E IG	PEL-N-257-00037-00001	5	3	air	0.31	0.28	0.39	57						
	with grilles-between-the-glass	PEL-N-257-00037-00002				0.31	0.26	0.35	57						
	with applied grilles	PEL-N-257-00037-00005				0.31	0.23	0.32	57				S		
1"	Gray Advanced Low-E IG	PEL-N-257-00039-00001	5	3	air	0.31	0.26	0.34	57						
	with grilles-between-the-glass	PEL-N-257-00039-00002				0.31	0.24	0.30	57						
	with applied grilles	PEL-N-257-00039-00005				0.31	0.22	0.27	57				S		
1"	Green Advanced Low-E IG	PEL-N-257-00041-00001	5	3	air	0.31	0.32	0.53	57						
	with grilles-between-the-glass	PEL-N-257-00041-00002				0.31	0.29	0.48	57						
	with applied grilles	PEL-N-257-00041-00005				0.31	0.26	0.43	57						
Fixed — Tinted Glazing with Foam Insulation and High Altitude Glazing															
1"	Bronze Advanced Low-E IG	PEL-N-257-00229-00001	5	3	air	0.30	0.28	0.39	58						
	with grilles-between-the-glass	PEL-N-257-00229-00002				0.30	0.26	0.35	58						
	with applied grilles	PEL-N-257-00229-00005				0.30	0.23	0.32	58				S		
1"	Gray Advanced Low-E IG	PEL-N-257-00231-00001	5	3	air	0.30	0.26	0.34	58						
	with grilles-between-the-glass	PEL-N-257-00231-00002				0.30	0.24	0.30	58						
	with applied grilles	PEL-N-257-00231-00005				0.30	0.22	0.27	58				S		
1"	Green Advanced Low-E IG	PEL-N-257-00233-00001	5	3	air	0.30	0.32	0.53	58						
	with grilles-between-the-glass	PEL-N-257-00233-00002				0.30	0.29	0.48	58						
	with applied grilles	PEL-N-257-00233-00005				0.30	0.26	0.43	58						

R-Value = 1/U-Factor
 SHGC = Solar Heat Gain Coefficient
 VLT % = Visible Light Transmission
 CR = Condensation Resistance
 ER = Canadian Energy Rating

U.S. Glazing performance values are calculated based on NFRC 100, NFRC 200 and NFRC 500. ENERGY STAR® values are updated to 2023 (version 7) criteria.

The Canadian values shown are based on the updated ENERGY STAR® 2020 initiative.

For center-glass values, see the Product Performance section.

Visit www.energystar.gov for Energy Star guidelines.

Climate Zones

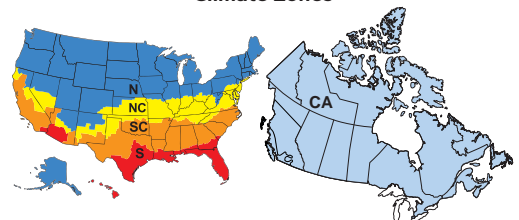



Impervia® Fixed Frame Windows

Glazing Performance - Total Unit

Glazing Thickness	Type of Glazing	NFRC Certified Product #	Glass (mm)		Gap Fill	U-Factor	SHGC	VLT	CR	Shaded Areas Meet ENERGY STAR® Performance Criteria in Zones Shown					
			Ext.	Int.						U. S.				Canada	
										Zone	ER	Zone	CA		
Fixed — Laminated for Sound Glazing										N	NC	SC	S		
1"	Clear IG	PEL-N-257-00103-00001	4	7	air	0.45	0.64	0.70	45						
	with grilles-between-the-glass	PEL-N-257-00103-00002				0.45	0.58	0.63	45						
	with applied grilles	PEL-N-257-00103-00005				0.45	0.52	0.56	45						
1"	Clear IG	PEL-N-257-00109-00001	5	10	air	0.44	0.62	0.69	44						
	with grilles-between-the-glass	PEL-N-257-00109-00002				0.44	0.56	0.62	44						
	with applied grilles	PEL-N-257-00109-00005				0.44	0.51	0.55	44						
1"	Advanced Low-E IG	PEL-N-257-00108-00001	4	7	argon	0.26	0.31	0.60	60						
	with grilles-between-the-glass	PEL-N-257-00108-00002				0.26	0.28	0.53	60						
	with applied grilles	PEL-N-257-00108-00005				0.26	0.26	0.48	60						
1"	Advanced Low-E IG	PEL-N-257-00114-00001	5	10	argon	0.25	0.31	0.59	59		NC				
	with grilles-between-the-glass	PEL-N-257-00114-00002				0.25	0.28	0.53	59		NC				
	with applied grilles	PEL-N-257-00114-00005				0.25	0.26	0.47	59		NC				
1"	SunDefense™ IG	PEL-N-257-00106-00001	4	7	argon	0.26	0.24	0.55	60						
	with grilles-between-the-glass	PEL-N-257-00106-00002				0.26	0.22	0.50	60			SC	S		
	with applied grilles	PEL-N-257-00106-00005				0.26	0.20	0.44	60			SC	S		
1"	SunDefense™ IG	PEL-N-257-00112-00001	5	10	argon	0.25	0.24	0.54	59		NC				
	with grilles-between-the-glass	PEL-N-257-00112-00002				0.25	0.22	0.49	59		NC	SC	S		
	with applied grilles	PEL-N-257-00112-00005				0.25	0.20	0.43	59		NC	SC	S		
Fixed — Laminated for Sound Glazing with Foam Insulation															
1"	Advanced Low-E IG	PEL-N-257-00300-00001	4	7	argon	0.26	0.31	0.60	60						
	with grilles-between-the-glass	PEL-N-257-00300-00002				0.26	0.28	0.53	60						
	with applied grilles	PEL-N-257-00300-00005				0.26	0.26	0.48	60						
1"	Advanced Low-E IG	PEL-N-257-00306-00001	5	10	argon	0.25	0.31	0.59	59		NC				
	with grilles-between-the-glass	PEL-N-257-00306-00002				0.25	0.28	0.53	59		NC				
	with applied grilles	PEL-N-257-00306-00005				0.25	0.26	0.47	59		NC				
1"	SunDefense IG	PEL-N-257-00298-00001	4	7	argon	0.25	0.24	0.55	61		NC				
	with grilles-between-the-glass	PEL-N-257-00298-00002				0.25	0.22	0.50	61		NC	SC	S		
	with applied grilles	PEL-N-257-00298-00005				0.25	0.20	0.44	61		NC	SC	S		
1"	SunDefense IG	PEL-N-257-00304-00001	5	10	argon	0.24	0.24	0.54	59		NC				
	with grilles-between-the-glass	PEL-N-257-00304-00002				0.24	0.22	0.49	59		NC	SC	S		
	with applied grilles	PEL-N-257-00304-00005				0.24	0.20	0.43	59		NC	SC	S		

R-Value = 1/U-Factor
 SHGC = Solar Heat Gain Coefficient
 VLT % = Visible Light Transmission
 CR = Condensation Resistance
 ER = Canadian Energy Rating

U.S. Glazing performance values are calculated based on NFRC 100, NFRC 200 and NFRC 500. ENERGY STAR® values are updated to 2023 (version 7) criteria.

The Canadian values shown are based on the updated ENERGY STAR® 2020 initiative.

For center-glass values, see the Product Performance section.

Visit www.energystar.gov for Energy Star guidelines.

Climate Zones

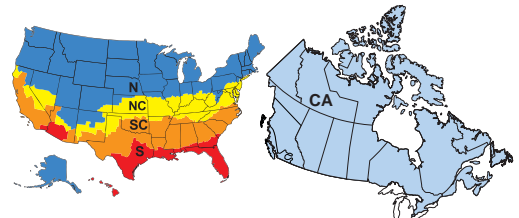



Impervia® Fixed Frame Windows

Glazing Performance - Total Unit

Glazing Thickness	Type of Glazing	NFRC Certified Product #	Glass (mm)		Gap Fill	U-Factor	SHGC	VLT	CR	Shaded Areas Meet ENERGY STAR® Performance Criteria in Zones Shown					
			Ext.	Int.						U. S.			Canada		
										Zone	ER	Zone	CA		
Fixed – Laminated for Sound with High Altitude Glazing										N	NC	SC	S		
1"	(HA) Advanced Low-E IG	PEL-N-257-00107-00001	4	7	air	0.30	0.32	0.60	56						
	with grilles-between-the-glass	PEL-N-257-00107-00002				0.30	0.29	0.53	56						
	with applied grilles	PEL-N-257-00107-00005				0.30	0.26	0.48	56						
1"	(HA) Advanced Low-E IG	PEL-N-257-00113-00001	5	10	air	0.30	0.32	0.59	55						
	with grilles-between-the-glass	PEL-N-257-00113-00002				0.30	0.29	0.53	55						
	with applied grilles	PEL-N-257-00113-00005				0.30	0.26	0.47	55						
1"	(HA) SunDefense IG	PEL-N-257-00105-00001	4	7	air	0.30	0.24	0.55	57						
	with grilles-between-the-glass	PEL-N-257-00105-00002				0.30	0.22	0.50	57				S		
	with applied grilles	PEL-N-257-00105-00005				0.30	0.20	0.44	57				S		
1"	(HA) SunDefense IG	PEL-N-257-00111-00001	5	10	air	0.29	0.24	0.54	55						
	with grilles-between-the-glass	PEL-N-257-00111-00002				0.29	0.22	0.49	55				S		
	with applied grilles	PEL-N-257-00111-00005				0.29	0.20	0.43	55				S		
Fixed – Laminated for Sound Glazing with Foam Insulation and High Altitude Glazing															
1"	(HA) Advanced Low-E IG	PEL-N-257-00299-00001	4	7	air	0.29	0.32	0.60	57						
	with grilles-between-the-glass	PEL-N-257-00299-00002				0.29	0.29	0.53	57						
	with applied grilles	PEL-N-257-00299-00005				0.29	0.26	0.48	57						
1"	(HA) Advanced Low-E IG	PEL-N-257-00305-00001	5	10	air	0.29	0.32	0.59	55						
	with grilles-between-the-glass	PEL-N-257-00305-00002				0.29	0.29	0.53	55						
	with applied grilles	PEL-N-257-00305-00005				0.29	0.26	0.47	55						
1"	(HA) SunDefense IG	PEL-N-257-00297-00001	4	7	air	0.29	0.24	0.55	57						
	with grilles-between-the-glass	PEL-N-257-00297-00002				0.29	0.22	0.50	57				S		
	with applied grilles	PEL-N-257-00297-00005				0.29	0.20	0.44	57				S		
1"	(HA) SunDefense IG	PEL-N-257-00303-00001	5	10	air	0.29	0.24	0.54	56						
	with grilles-between-the-glass	PEL-N-257-00303-00002				0.29	0.22	0.49	56				S		
	with applied grilles	PEL-N-257-00303-00005				0.29	0.20	0.43	56				S		

R-Value = 1/U-Factor
 SHGC = Solar Heat Gain Coefficient
 VLT % = Visible Light Transmission
 CR = Condensation Resistance
 ER = Canadian Energy Rating

U.S. Glazing performance values are calculated based on NFRC 100, NFRC 200 and NFRC 500. ENERGY STAR® values are updated to 2023 (version 7) criteria.

The Canadian values shown are based on the updated ENERGY STAR® 2020 initiative.

For center-glass values, see the Product Performance section.

Visit www.energystar.gov for Energy Star guidelines.

Climate Zones

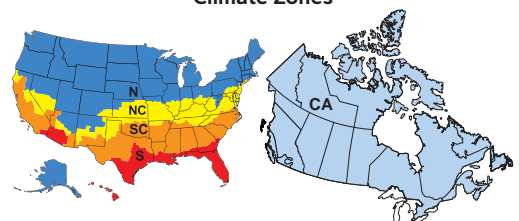



Impervia® Fixed Frame Windows

Glazing Performance - Total Unit

Glazing Thickness	Type of Glazing	NFRC Certified Product #	Glass (mm)		Gap Fill	U-Factor	SHGC	VLT	CR	Shaded Areas Meet ENERGY STAR® Performance Criteria in Zones Shown					
			Ext.	Int.						U. S.			Canada		
										Zone	ER	Zone	ER	Zone	
Fixed — with Impact-Resistant Laminated Glazing										N	NC	SC	S		CA
1"	Clear IG (PVB)	PEL-N-257-00385-00001	3	8.6	air	0.44	0.64	0.70	45						
	with grilles-between-the-glass	PEL-N-257-00386-00001				0.44	0.58	0.63	45						
	with applied grilles	PEL-N-257-02345-00001				0.44	0.52	0.56	45						
1"	Clear IG (SGP)	PEL-N-257-00887-00001	5	10.1	air	0.45	0.62	0.69	45						
	with grilles-between-the-glass	PEL-N-257-00888-00001				0.45	0.56	0.62	45						
	with applied grilles	PEL-N-257-02353-00001				0.45	0.51	0.56	45						
1"	Clear IG (SGP)	PEL-N-257-01067-00001	5	11.7	air	0.45	0.61	0.68	44						
	with grilles-between-the-glass	PEL-N-257-01068-00001				0.46	0.55	0.61	44						
	with applied grilles	PEL-N-257-02361-00001				0.45	0.50	0.54	44						
1-1/4"	Clear IG (PVB)	PEL-N-257-01173-00001	6	13.6	air	0.43	0.59	0.67	46						
	with grilles-between-the-glass	PEL-N-257-01174-00001				0.43	0.53	0.60	46						
	with applied grilles	PEL-N-257-02367-00001				0.43	0.48	0.54	46						
1-1/4"	Clear IG (SGP)	PEL-N-257-01281-00001	6	13.6	air	0.43	0.59	0.66	46						
	with grilles-between-the-glass	PEL-N-257-01282-00001				0.43	0.53	0.59	46						
	with applied grilles	PEL-N-257-02375-00001				0.43	0.48	0.53	46						
1"	Advanced Low-E IG (PVB)	PEL-N-257-00435-00001	3	8.6	argon	0.26	0.32	0.59	60						
	with grilles-between-the-glass	PEL-N-257-00436-00001				0.26	0.29	0.53	60						
	with applied grilles	PEL-N-257-02350-00001				0.26	0.26	0.47	60						
1"	Advanced Low-E IG (SGP)	PEL-N-257-00919-00001	5	10.1	argon	0.26	0.31	0.59	59						
	with grilles-between-the-glass	PEL-N-257-00920-00001				0.27	0.28	0.53	59						
	with applied grilles	PEL-N-257-02356-00001				0.26	0.26	0.47	59						
1"	Advanced Low-E IG (SGP)	PEL-N-257-01115-00001	5	11.7	argon	0.26	0.31	0.57	58						
	with grilles-between-the-glass	PEL-N-257-01116-00001				0.28	0.29	0.52	58						
	with applied grilles	PEL-N-257-02366-00001				0.26	0.26	0.46	58						
1-1/4"	Advanced Low-E IG (PVB)	PEL-N-257-01223-00001	6	13.6	argon	0.25	0.31	0.57	60		NC				
	with grilles-between-the-glass	PEL-N-257-01224-00001				0.25	0.28	0.51	60		NC				
	with applied grilles	PEL-N-257-02372-00001				0.25	0.25	0.46	60		NC				
1-1/4"	Advanced Low-E IG (SGP)	PEL-N-257-01331-00001	6	13.6	argon	0.25	0.31	0.56	59		NC				
	with grilles-between-the-glass	PEL-N-257-01332-00001				0.25	0.28	0.50	59		NC				
	with applied grilles	PEL-N-257-02380-00001				0.25	0.25	0.45	59		NC				
1"	SunDefense™ IG (PVB)	PEL-N-257-00411-00001	3	8.6	argon	0.25	0.23	0.55	61		NC	SC	S		
	with grilles-between-the-glass	PEL-N-257-00412-00001				0.25	0.21	0.49	61		NC	SC	S		
	with applied grilles	PEL-N-257-02348-00001				0.25	0.19	0.44	61		NC	SC	S		
1"	SunDefense™ IG (SGP)	PEL-N-257-00905-00001	5	10.1	argon	0.25	0.24	0.55	59		NC				
	with grilles-between-the-glass	PEL-N-257-00906-00001				0.27	0.22	0.49	59			SC	S		
	with applied grilles	PEL-N-257-02358-00001				0.25	0.20	0.44	59		NC	SC	S		
1"	SunDefense™ IG (SGP)	PEL-N-257-01093-00001	5	11.7	argon	0.26	0.24	0.53	58						
	with grilles-between-the-glass	PEL-N-257-01094-00001				0.28	0.22	0.48	58			SC	S		
	with applied grilles	PEL-N-257-02364-00001				0.26	0.20	0.43	58			SC	S		
1-1/4"	SunDefense™ IG (PVB)	PEL-N-257-01199-00001	6	13.6	argon	0.25	0.23	0.53	60		NC	SC	S		
	with grilles-between-the-glass	PEL-N-257-01200-00001				0.25	0.21	0.48	60		NC	SC	S		
	with applied grilles	PEL-N-257-02370-00001				0.25	0.19	0.42	60		NC	SC	S		
1-1/4"	SunDefense™ IG (SGP)	PEL-N-257-01307-00001	6	13.6	argon	0.25	0.24	0.52	60		NC				
	with grilles-between-the-glass	PEL-N-257-01308-00001				0.25	0.22	0.47	60		NC	SC	S		
	with applied grilles	PEL-N-257-02378-00001				0.25	0.20	0.41	60		NC	SC	S		
1"	Bronze Advanced Low-E IG (PVB)	PEL-N-257-00447-00001	3	8.6	argon	0.26	0.31	0.43	61						
	with grilles-between-the-glass	PEL-N-257-00448-00001				0.26	0.28	0.39	61						
	with applied grilles	PEL-N-257-02352-00001				0.26	0.25	0.35	61						
1"	Bronze Advanced Low-E IG (SGP)	PEL-N-257-00923-00001	5	10.1	argon	0.26	0.30	0.41	59						
	with grilles-between-the-glass	PEL-N-257-00924-00001				0.27	0.28	0.36	59						
	with applied grilles	PEL-N-257-02360-00001				0.26	0.25	0.32	59						
1-1/4"	Bronze Advanced Low-E IG (PVB)	PEL-N-257-01235-00001	6	13.6	argon	0.25	0.30	0.33	59		NC				
	with grilles-between-the-glass	PEL-N-257-01236-00001				0.25	0.27	0.30	59		NC				
	with applied grilles	PEL-N-257-02374-00001				0.25	0.24	0.26	59		NC				

U.S. Glazing performance values are calculated based on NFRC 100, NFRC 200 and NFRC 500. ENERGY STAR® values are updated to 2023 (version 7) criteria.

The Canadian values shown are based on the updated ENERGY STAR® 2020 initiative.

For center-glass values, see the Product Performance section.

Visit www.energystar.gov for Energy Star guidelines.

R-Value = 1/U-Factor
 SHGC = Solar Heat Gain Coefficient
 VLT % = Visible Light Transmission
 CR = Condensation Resistance
 ER = Canadian Energy Rating



Impervia® Fixed Frame Windows

Glazing Performance - Total Unit

Glazing Thickness	Type of Glazing	NFRC Certified Product #	Glass (mm)		Gap Fill	U-Factor	SHGC	VLT	CR	Shaded Areas Meet ENERGY STAR® Performance Criteria in Zones Shown				
			Ext.	Int.						U. S.			Canada	
										Zone	ER	Zone	ER	
Fixed — with Foam Insulation and Impact-Resistant Laminated Glazing										N	NC	SC	S	CA
1"	Advanced Low-E IG (PVB)	PEL-N-257-01415-00001	3	8.6	argon	0.25	0.32	0.59	61	NC				
	with grilles-between-the-glass	PEL-N-257-01416-00001				0.25	0.29	0.53	61	NC				
	with applied grilles	PEL-N-257-02386-00001				0.25	0.26	0.47	61	NC				
1"	Advanced Low-E IG (SGP)	PEL-N-257-01899-00001	5	10.1	argon	0.25	0.31	0.59	60	NC				
	with grilles-between-the-glass	PEL-N-257-01900-00001				0.25	0.28	0.53	60	NC				
	with applied grilles	PEL-N-257-02392-00001				0.25	0.26	0.47	60	NC				
1"	Advanced Low-E IG (SGP)	PEL-N-257-02095-00001	5	11.7	argon	0.26	0.31	0.57	59					
	with grilles-between-the-glass	PEL-N-257-02096-00001				0.26	0.29	0.52	59					
	with applied grilles	PEL-N-257-02402-00001				0.26	0.26	0.46	59					
1-1/4"	Advanced Low-E IG (PVB)	PEL-N-257-02203-00001	6	13.6	argon	0.25	0.31	0.57	60	NC				
	with grilles-between-the-glass	PEL-N-257-02204-00001				0.25	0.28	0.51	60	NC				
	with applied grilles	PEL-N-257-02408-00001				0.25	0.25	0.46	60	NC				
1-1/4"	Advanced Low-E IG (SGP)	PEL-N-257-02311-00001	6	13.6	argon	0.25	0.31	0.56	60	NC				
	with grilles-between-the-glass	PEL-N-257-02312-00001				0.25	0.28	0.50	60	NC				
	with applied grilles	PEL-N-257-02416-00001				0.25	0.25	0.45	60	NC				
1"	SunDefense™ IG (PVB)	PEL-N-257-01391-00001	3	8.6	argon	0.25	0.23	0.55	61	NC	SC	S		
	with grilles-between-the-glass	PEL-N-257-01392-00001				0.25	0.21	0.49	61	NC	SC	S		
	with applied grilles	PEL-N-257-02384-00001				0.25	0.19	0.44	61	NC	SC	S		
1"	SunDefense™ IG (SGP)	PEL-N-257-01885-00001	5	10.1	argon	0.25	0.24	0.55	60	NC				
	with grilles-between-the-glass	PEL-N-257-01886-00001				0.25	0.22	0.49	60	NC	SC	S		
	with applied grilles	PEL-N-257-02394-00001				0.25	0.20	0.44	60	NC	SC	S		
1"	SunDefense™ IG (SGP)	PEL-N-257-02073-00001	5	11.7	argon	0.25	0.24	0.53	59	NC				
	with grilles-between-the-glass	PEL-N-257-02074-00001				0.25	0.22	0.48	59	NC	SC	S		
	with applied grilles	PEL-N-257-02400-00001				0.25	0.20	0.43	59	NC	SC	S		
1-1/4"	SunDefense™ IG (PVB)	PEL-N-257-02179-00001	6	13.6	argon	0.24	0.23	0.53	60	NC	SC	S		
	with grilles-between-the-glass	PEL-N-257-02180-00001				0.24	0.21	0.48	60	NC	SC	S		
	with applied grilles	PEL-N-257-02406-00001				0.24	0.19	0.42	60	NC	SC	S		
1-1/4"	SunDefense™ IG (SGP)	PEL-N-257-02287-00001	6	13.6	argon	0.24	0.24	0.52	60	NC				
	with grilles-between-the-glass	PEL-N-257-02288-00001				0.24	0.22	0.47	60	NC	SC	S		
	with applied grilles	PEL-N-257-02414-00001				0.24	0.20	0.41	60	NC	SC	S		
1"	Bronze Advanced Low-E IG (PVB)	PEL-N-257-01427-00001	3	8.6	argon	0.25	0.31	0.43	61	NC				
	with grilles-between-the-glass	PEL-N-257-01428-00001				0.25	0.28	0.39	61	NC				
	with applied grilles	PEL-N-257-02388-00001				0.25	0.25	0.35	61	NC				
1"	Bronze Advanced Low-E IG (SGP)	PEL-N-257-01903-00001	5	10.1	argon	0.25	0.30	0.41	59	NC				
	with grilles-between-the-glass	PEL-N-257-01904-00001				0.25	0.28	0.36	59	NC				
	with applied grilles	PEL-N-257-02396-00001				0.25	0.25	0.32	59	NC				
1-1/4"	Bronze Advanced Low-E IG (PVB)	PEL-N-257-02215-00001	6	13.6	argon	0.25	0.30	0.33	60	NC				
	with grilles-between-the-glass	PEL-N-257-02216-00001				0.25	0.27	0.30	60	NC				
	with applied grilles	PEL-N-257-02410-00001				0.25	0.24	0.26	60	NC				

R-Value = 1/U-Factor
 SHGC = Solar Heat Gain Coefficient
 VLT % = Visible Light Transmission
 CR = Condensation Resistance
 ER = Canadian Energy Rating

U.S. Glazing performance values are calculated based on NFRC 100, NFRC 200 and NFRC 500. ENERGY STAR® values are updated to 2023 (version 7) criteria.

The Canadian values shown are based on the updated ENERGY STAR® 2020 initiative.

For center-glass values, see the Product Performance section.

Visit www.energystar.gov for Energy Star guidelines.

Climate Zones

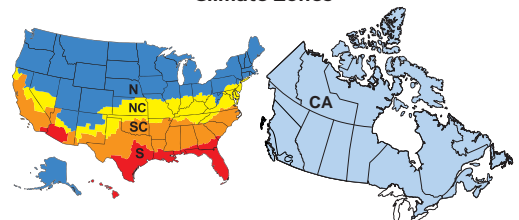



Impervia® Fixed Frame Windows

Glazing Performance - Total Unit

Glazing Thickness	Type of Glazing	NFRC Certified Product #	Glass (mm)			Gap Fill	U-Factor	SHGC	VLT	CR	Shaded Areas Meet ENERGY STAR® Performance Criteria in Zones Shown					
			Ext.	Mid.	Int.						U. S.				Canada	
											Zone				ER	Zone
			Fixed — Triple-Pane Glazing											N	NC	SC
1-1/4"	Advanced Low-E IG	PEL-N-257-00137-00001	3	3	3	argon	0.16	0.29	0.54	73	N	NC			37	CA
	with grilles-between-the-glass	PEL-N-257-00137-00002					0.16	0.26	0.48	73	N	NC			35	CA
	with applied grilles	PEL-N-257-00137-00005					0.16	0.24	0.43	73	N	NC			34	CA
1-1/4"	Advanced Low-E IG	PEL-N-257-00141-00001	4	4	4	argon	0.17	0.28	0.53	71	N	NC			35	CA
	with grilles-between-the-glass	PEL-N-257-00142-00001					0.17	0.26	0.47	71	N	NC			34	CA
	with applied grilles	PEL-N-257-00141-00002					0.17	0.23	0.42	71	N	NC	SC	S	32	CA
1-1/4"	Advanced Low-E IG	PEL-N-257-00147-00001	5	5	5	argon	0.19	0.28	0.52	69	N	NC			32	CA
	with grilles-between-the-glass	PEL-N-257-00148-00001					0.19	0.26	0.47	69	N	NC			31	CA
	with applied grilles	PEL-N-257-00147-00002					0.19	0.23	0.42	69	N	NC	SC	S	29	CA
1-1/4"	Advanced Low-E IG	PEL-N-257-00153-00001	6	6	6	argon	0.21	0.28	0.51	66	N	NC			30	CA
	with grilles-between-the-glass	PEL-N-257-00154-00001					0.22	0.25	0.46	66	N	NC				
	with applied grilles	PEL-N-257-00153-00002					0.21	0.23	0.41	66	N	NC	SC	S	27	CA
1-1/4"	SunDefense™ IG	PEL-N-257-00158-00001	3	3	3	argon	0.16	0.22	0.50	73	N	NC	SC	S	33	CA
	with grilles-between-the-glass	PEL-N-257-00158-00002					0.16	0.20	0.45	73	N	NC	SC	S	31	CA
	with applied grilles	PEL-N-257-00158-00005					0.16	0.18	0.40	73	N	NC	SC	S	30	CA
1-1/4"	SunDefense™ IG	PEL-N-257-00162-00001	4	4	4	argon	0.17	0.22	0.49	71	N	NC	SC	S	31	CA
	with grilles-between-the-glass	PEL-N-257-00163-00001					0.17	0.20	0.44	71	N	NC	SC	S	30	CA
	with applied grilles	PEL-N-257-00162-00002					0.17	0.18	0.39	71	N	NC	SC	S	29	CA
1-1/4"	SunDefense™ IG	PEL-N-257-00168-00001	5	5	5	argon	0.19	0.22	0.48	69	N	NC	SC	S	29	CA
	with grilles-between-the-glass	PEL-N-257-00169-00001					0.19	0.20	0.43	69	N	NC	SC	S	28	CA
	with applied grilles	PEL-N-257-00168-00002					0.19	0.18	0.39	69	N	NC	SC	S	27	CA
1-1/4"	SunDefense™ IG	PEL-N-257-00174-00001	6	6	6	argon	0.21	0.22	0.47	66	N	NC	SC	S	26	CA
	with grilles-between-the-glass	PEL-N-257-00175-00001					0.22	0.20	0.42	66	N	NC	SC	S		
	with applied grilles	PEL-N-257-00174-00002					0.21	0.18	0.38	66	N	NC	SC	S	24	CA
1-1/4"	NaturalSun Low-E IG	PEL-N-257-00116-00001	3	3	3	argon	0.16	0.49	0.61	73	N				48	CA
	with grilles-between-the-glass	PEL-N-257-00116-00002					0.16	0.44	0.55	73	N				45	CA
	with applied grilles	PEL-N-257-00116-00005					0.16	0.40	0.49	73	N	NC			43	CA
1-1/4"	NaturalSun Low-E IG	PEL-N-257-00120-00001	4	4	4	argon	0.17	0.47	0.60	70	N				46	CA
	with grilles-between-the-glass	PEL-N-257-00121-00001					0.18	0.43	0.54	70	N				42	CA
	with applied grilles	PEL-N-257-00120-00002					0.17	0.39	0.48	70	N	NC			41	CA
1-1/4"	NaturalSun Low-E IG	PEL-N-257-00126-00001	5	5	5	argon	0.19	0.47	0.59	68	N				43	CA
	with grilles-between-the-glass	PEL-N-257-00127-00001					0.20	0.42	0.53	68	N				39	CA
	with applied grilles	PEL-N-257-00126-00002					0.19	0.38	0.47	68	N	NC			38	CA
1-1/4"	NaturalSun Low-E IG	PEL-N-257-00132-00001	6	6	6	argon	0.21	0.45	0.58	65	N				40	CA
	with grilles-between-the-glass	PEL-N-257-00133-00001					0.22	0.41	0.52	65	N				36	CA
	with applied grilles	PEL-N-257-00132-00002					0.21	0.37	0.46	65	N	NC			35	CA

Continued on next page

R-Value = 1/U-Factor
 SHGC = Solar Heat Gain Coefficient
 VLT % = Visible Light Transmission
 CR = Condensation Resistance
 ER = Canadian Energy Rating

U.S. Glazing performance values are calculated based on NFRC 100, NFRC 200 and NFRC 500. ENERGY STAR® values are updated to 2023 (version 7) criteria.
 The Canadian values shown are based on the updated ENERGY STAR® 2020 initiative.
 For center-glass values, see the Product Performance section.
 Visit www.energystar.gov for Energy Star guidelines.

Climate Zones

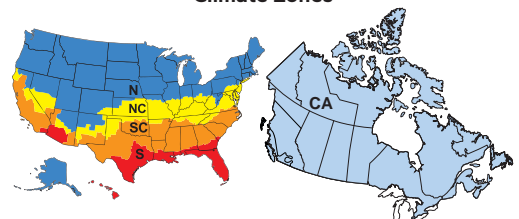



Impervia® Fixed Frame Windows

Glazing Performance - Total Unit

Glazing Thickness	Type of Glazing	NFRC Certified Product #	Glass (mm)			Gap Fill	U-Factor	SHGC	VLT	CR	Shaded Areas Meet ENERGY STAR® Performance Criteria in Zones Shown					
			Ext.	Mid.	Int.						U. S.		Canada			
											Zone		ER	Zone		
Fixed — Triple-Pane Glazing and Foam Insulation											N	NC	SC	S	CA	
1-1/4"	Advanced Low-E IG	PEL-N-257-00329-00001	3	3	3	argon	0.15	0.29	0.54	74	N	NC			38	CA
	with grilles-between-the-glass	PEL-N-257-00329-00002					0.15	0.26	0.48	74	N	NC			36	CA
	with applied grilles	PEL-N-257-00329-00005					0.15	0.24	0.43	74	N	NC			35	CA
1-1/4"	Advanced Low-E IG	PEL-N-257-00333-00001	4	4	4	argon	0.16	0.28	0.53	71	N	NC			36	CA
	with grilles-between-the-glass	PEL-N-257-00334-00001					0.17	0.26	0.47	71	N	NC			34	CA
	with applied grilles	PEL-N-257-00333-00002					0.16	0.23	0.42	71	N	NC	SC	S	33	CA
1-1/4"	Advanced Low-E IG	PEL-N-257-00339-00001	5	5	5	argon	0.18	0.28	0.52	69	N	NC			34	CA
	with grilles-between-the-glass	PEL-N-257-00340-00001					0.19	0.26	0.47	69	N	NC			31	CA
	with applied grilles	PEL-N-257-00339-00002					0.18	0.23	0.42	69	N	NC	SC	S	31	CA
1-1/4"	Advanced Low-E IG	PEL-N-257-00345-00001	6	6	6	argon	0.20	0.28	0.51	66	N	NC			31	CA
	with grilles-between-the-glass	PEL-N-257-00346-00001					0.21	0.25	0.46	66	N	NC			28	CA
	with applied grilles	PEL-N-257-00345-00002					0.20	0.23	0.41	66	N	NC	SC	S	28	CA
1-1/4"	SunDefense IG	PEL-N-257-00350-00001	3	3	3	argon	0.15	0.22	0.50	74	N	NC	SC	S	34	CA
	with grilles-between-the-glass	PEL-N-257-00350-00002					0.15	0.20	0.45	74	N	NC	SC	S	33	CA
	with applied grilles	PEL-N-257-00350-00005					0.15	0.18	0.40	74	N	NC	SC	S	32	CA
1-1/4"	SunDefense IG	PEL-N-257-00354-00001	4	4	4	argon	0.16	0.22	0.49	72	N	NC	SC	S	33	CA
	with grilles-between-the-glass	PEL-N-257-00355-00001					0.17	0.20	0.44	72	N	NC	SC	S	30	CA
	with applied grilles	PEL-N-257-00354-00002					0.16	0.18	0.39	72	N	NC	SC	S	30	CA
1-1/4"	SunDefense IG	PEL-N-257-00360-00001	5	5	5	argon	0.18	0.22	0.48	69	N	NC	SC	S	30	CA
	with grilles-between-the-glass	PEL-N-257-00361-00001					0.19	0.20	0.43	69	N	NC	SC	S	28	CA
	with applied grilles	PEL-N-257-00360-00002					0.18	0.18	0.39	69	N	NC	SC	S	28	CA
1-1/4"	SunDefense IG	PEL-N-257-00366-00001	6	6	6	argon	0.20	0.22	0.47	66	N	NC	SC	S	28	CA
	with grilles-between-the-glass	PEL-N-257-00367-00001					0.21	0.20	0.42	66	N	NC	SC	S	25	CA
	with applied grilles	PEL-N-257-00366-00002					0.20	0.18	0.38	66	N	NC	SC	S	25	CA
1-1/4"	NaturalSun Low-E IG	PEL-N-257-00308-00001	3	3	3	argon	0.16	0.49	0.61	73	N				48	CA
	with grilles-between-the-glass	PEL-N-257-00308-00002					0.16	0.44	0.55	73	N				45	CA
	with applied grilles	PEL-N-257-00308-00005					0.16	0.40	0.49	73	N	NC			43	CA
1-1/4"	NaturalSun Low-E IG	PEL-N-257-00312-00001	4	4	4	argon	0.17	0.47	0.60	71	N				46	CA
	with grilles-between-the-glass	PEL-N-257-00313-00001					0.17	0.43	0.54	71	N				43	CA
	with applied grilles	PEL-N-257-00312-00002					0.17	0.39	0.48	71	N	NC			41	CA
1-1/4"	NaturalSun Low-E IG	PEL-N-257-00318-00001	5	5	5	argon	0.19	0.47	0.59	69	N				43	CA
	with grilles-between-the-glass	PEL-N-257-00319-00001					0.19	0.42	0.53	69	N				40	CA
	with applied grilles	PEL-N-257-00318-00002					0.19	0.38	0.47	69	N	NC			38	CA
1-1/4"	NaturalSun Low-E IG	PEL-N-257-00324-00001	6	6	6	argon	0.21	0.45	0.58	66	N				40	CA
	with grilles-between-the-glass	PEL-N-257-00325-00001					0.22	0.41	0.52	66	N				36	CA
	with applied grilles	PEL-N-257-00324-00002					0.21	0.37	0.46	66	N	NC			35	CA

Continued on next page

R-Value = 1/U-Factor
 SHGC = Solar Heat Gain Coefficient
 VLT % = Visible Light Transmission
 CR = Condensation Resistance
 ER = Canadian Energy Rating

U.S. Glazing performance values are calculated based on NFRC 100, NFRC 200 and NFRC 500. ENERGY STAR® values are updated to 2023 (version 7) criteria.

The Canadian values shown are based on the updated ENERGY STAR® 2020 initiative.

For center-glass values, see the Product Performance section.

Visit www.energystar.gov for Energy Star guidelines.

Climate Zones

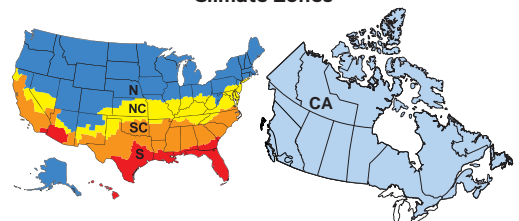



Impervia® Fixed Frame Windows

Glazing Performance - Total Unit

Glazing Thickness	Type of Glazing	NFRC Certified Product #	Glass (mm)			Gap Fill	U-Factor	SHGC	VLT	CR	Shaded Areas Meet ENERGY STAR® Performance Criteria in Zones Shown					
			Ext.	Mid.	Int.						U. S.		Canada			
											Zone		ER	Zone		
Fixed — Triple-Pane High Altitude Glazing											N	NC	SC	S		
1-1/4"	(HA) Advanced Low-E IG	PEL-N-257-00136-00001	3	3	3	air	0.19	0.29	0.54	69	N	NC			33	CA
	with grilles-between-the-glass	PEL-N-257-00136-00002					0.19	0.27	0.48	69	N	NC			32	CA
	with applied grilles	PEL-N-257-00136-00005					0.19	0.24	0.43	69	N	NC			30	CA
1-1/4"	(HA) Advanced Low-E IG	PEL-N-257-00139-00001	4	4	4	air	0.20	0.29	0.53	67	N	NC			32	CA
	with grilles-between-the-glass	PEL-N-257-00140-00001					0.21	0.26	0.47	67	N	NC			29	CA
	with applied grilles	PEL-N-257-00139-00002					0.20	0.24	0.42	67	N	NC			29	CA
1-1/4"	(HA) Advanced Low-E IG	PEL-N-257-00145-00001	5	5	5	air	0.23	0.29	0.52	65		NC				
	with grilles-between-the-glass	PEL-N-257-00146-00001					0.23	0.26	0.47	65		NC				
	with applied grilles	PEL-N-257-00145-00002					0.23	0.24	0.42	65		NC				
1-1/4"	(HA) Advanced Low-E IG	PEL-N-257-00151-00001	6	6	6	air	0.25	0.28	0.51	62		NC				
	with grilles-between-the-glass	PEL-N-257-00152-00001					0.26	0.26	0.46	62						
	with applied grilles	PEL-N-257-00151-00002					0.25	0.23	0.41	62		NC	SC	S		
1-1/4"	(HA) SunDefense IG	PEL-N-257-00157-00001	3	3	3	air	0.19	0.22	0.50	70	N	NC	SC	S	29	CA
	with grilles-between-the-glass	PEL-N-257-00157-00002					0.19	0.20	0.45	70	N	NC	SC	S	28	CA
	with applied grilles	PEL-N-257-00157-00005					0.19	0.18	0.40	70	N	NC	SC	S	27	CA
1-1/4"	(HA) SunDefense IG	PEL-N-257-00160-00001	4	4	4	air	0.20	0.22	0.49	67	N	NC	SC	S	28	CA
	with grilles-between-the-glass	PEL-N-257-00161-00001					0.21	0.20	0.44	67	N	NC	SC	S	25	CA
	with applied grilles	PEL-N-257-00160-00002					0.20	0.18	0.39	67	N	NC	SC	S	25	CA
1-1/4"	(HA) SunDefense IG	PEL-N-257-00166-00001	5	5	5	air	0.23	0.22	0.48	65		NC	SC	S		
	with grilles-between-the-glass	PEL-N-257-00167-00001					0.23	0.20	0.43	65		NC	SC	S		
	with applied grilles	PEL-N-257-00166-00002					0.23	0.18	0.39	65		NC	SC	S		
1-1/4"	(HA) SunDefense IG	PEL-N-257-00172-00001	6	6	6	air	0.25	0.22	0.47	62		NC	SC	S		
	with grilles-between-the-glass	PEL-N-257-00173-00001					0.26	0.20	0.42	62			SC	S		
	with applied grilles	PEL-N-257-00172-00002					0.25	0.18	0.38	62		NC	SC	S		
1-1/4"	(HA) NaturalSun Low-E IG	PEL-N-257-00115-00001	3	3	3	air	0.19	0.49	0.61	69	N				44	CA
	with grilles-between-the-glass	PEL-N-257-00115-00002					0.19	0.44	0.55	69	N				42	CA
	with applied grilles	PEL-N-257-00115-00005					0.19	0.40	0.49	69	N	NC			39	CA
1-1/4"	(HA) NaturalSun Low-E IG	PEL-N-257-00118-00001	4	4	4	air	0.21	0.47	0.60	67	N				41	CA
	with grilles-between-the-glass	PEL-N-257-00119-00001					0.21	0.43	0.54	67	N				39	CA
	with applied grilles	PEL-N-257-00118-00002					0.21	0.39	0.48	67	N	NC			36	CA
1-1/4"	(HA) NaturalSun Low-E IG	PEL-N-257-00124-00001	5	5	5	air	0.23	0.47	0.59	65	N				38	CA
	with grilles-between-the-glass	PEL-N-257-00125-00001					0.24	0.42	0.53	65	N				34	CA
	with applied grilles	PEL-N-257-00124-00002					0.23	0.38	0.47	65	N	NC				
1-1/4"	(HA) NaturalSun Low-E IG	PEL-N-257-00130-00001	6	6	6	air	0.26	0.45	0.58	62	N					
	with grilles-between-the-glass	PEL-N-257-00131-00001					0.27	0.41	0.52	62						
	with applied grilles	PEL-N-257-00130-00002					0.26	0.37	0.46	62						

R-Value = 1/U-Factor
 SHGC = Solar Heat Gain Coefficient
 VLT % = Visible Light Transmission
 CR = Condensation Resistance
 ER = Canadian Energy Rating

U.S. Glazing performance values are calculated based on NFRC 100, NFRC 200 and NFRC 500. ENERGY STAR® values are updated to 2023 (version 7) criteria.
 The Canadian values shown are based on the updated ENERGY STAR® 2020 initiative.
 For center-glass values, see the Product Performance section.
 Visit www.energystar.gov for Energy Star guidelines.

Climate Zones

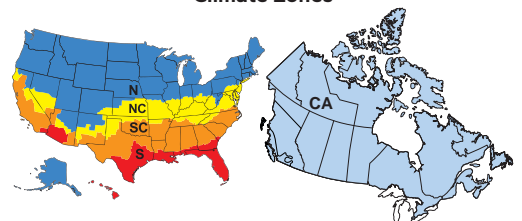



Glazing Thickness	Type of Glazing	NFRC Certified Product #	Glass (mm)			Gap Fill	U-Factor	SHGC	VLT	CR	Shaded Areas Meet ENERGY STAR® Performance Criteria in Zones Shown					
			Ext.	Mid.	Int.						U. S.				Canada	
											Zone				ER	Zone
			Fixed — Triple-Pane High Altitude Glazing and Foam Insulation											N	NC	SC
1-1/4"	(HA) Advanced Low-E IG	PEL-N-257-00328-00001	3	3	3	air	0.18	0.29	0.54	70	N	NC			34	CA
	with grilles-between-the-glass	PEL-N-257-00328-00002					0.18	0.27	0.48	70	N	NC			33	CA
	with applied grilles	PEL-N-257-00328-00005					0.18	0.24	0.43	70	N	NC			31	CA
1-1/4"	(HA) Advanced Low-E IG	PEL-N-257-00331-00001	4	4	4	air	0.20	0.29	0.53	67	N	NC			32	CA
	with grilles-between-the-glass	PEL-N-257-00332-00001					0.20	0.26	0.47	67	N	NC			30	CA
	with applied grilles	PEL-N-257-00331-00002					0.20	0.24	0.42	67	N	NC			29	CA
1-1/4"	(HA) Advanced Low-E IG	PEL-N-257-00337-00001	5	5	5	air	0.22	0.29	0.52	65	N	NC				
	with grilles-between-the-glass	PEL-N-257-00338-00001					0.23	0.26	0.47	65		NC				
	with applied grilles	PEL-N-257-00337-00002					0.22	0.24	0.42	65	N	NC				
1-1/4"	(HA) Advanced Low-E IG	PEL-N-257-00343-00001	6	6	6	air	0.25	0.28	0.51	62		NC				
	with grilles-between-the-glass	PEL-N-257-00344-00001					0.26	0.26	0.46	62						
	with applied grilles	PEL-N-257-00343-00002					0.25	0.23	0.41	62		NC	SC	S		
1-1/4"	(HA) SunDefense IG	PEL-N-257-00349-00001	3	3	3	air	0.18	0.22	0.50	70	N	NC	SC	S	30	CA
	with grilles-between-the-glass	PEL-N-257-00349-00002					0.18	0.20	0.45	70	N	NC	SC	S	29	CA
	with applied grilles	PEL-N-257-00349-00005					0.18	0.18	0.40	70	N	NC	SC	S	28	CA
1-1/4"	(HA) SunDefense IG	PEL-N-257-00352-00001	4	4	4	air	0.20	0.22	0.49	68	N	NC	SC	S	28	CA
	with grilles-between-the-glass	PEL-N-257-00353-00001					0.20	0.20	0.44	68	N	NC	SC	S	26	CA
	with applied grilles	PEL-N-257-00352-00002					0.20	0.18	0.39	68	N	NC	SC	S	25	CA
1-1/4"	(HA) SunDefense IG	PEL-N-257-00358-00001	5	5	5	air	0.22	0.22	0.48	65	N	NC	SC	S		
	with grilles-between-the-glass	PEL-N-257-00359-00001					0.23	0.20	0.43	65		NC	SC	S		
	with applied grilles	PEL-N-257-00358-00002					0.22	0.18	0.39	65	N	NC	SC	S		
1-1/4"	(HA) SunDefense IG	PEL-N-257-00364-00001	6	6	6	air	0.25	0.22	0.47	62		NC	SC	S		
	with grilles-between-the-glass	PEL-N-257-00365-00001					0.26	0.20	0.42	62			SC	S		
	with applied grilles	PEL-N-257-00364-00002					0.25	0.18	0.38	62		NC	SC	S		
1-1/4"	(HA) NaturalSun Low-E IG	PEL-N-257-00307-00001	3	3	3	air	0.19	0.49	0.61	69	N				44	CA
	with grilles-between-the-glass	PEL-N-257-00307-00002					0.19	0.44	0.55	69	N				42	CA
	with applied grilles	PEL-N-257-00307-00005					0.19	0.40	0.49	69	N	NC			39	CA
1-1/4"	(HA) NaturalSun Low-E IG	PEL-N-257-00310-00001	4	4	4	air	0.20	0.47	0.60	67	N				42	CA
	with grilles-between-the-glass	PEL-N-257-00311-00001					0.21	0.43	0.54	67	N				39	CA
	with applied grilles	PEL-N-257-00310-00002					0.20	0.39	0.48	67	N	NC			37	CA
1-1/4"	(HA) NaturalSun Low-E IG	PEL-N-257-00316-00001	5	5	5	air	0.22	0.47	0.59	65	N				40	CA
	with grilles-between-the-glass	PEL-N-257-00317-00001					0.23	0.42	0.53	65	N				35	CA
	with applied grilles	PEL-N-257-00316-00002					0.22	0.38	0.47	65	N	NC			34	CA
1-1/4"	(HA) NaturalSun Low-E IG	PEL-N-257-00322-00001	6	6	6	air	0.25	0.45	0.58	62	N				35	CA
	with grilles-between-the-glass	PEL-N-257-00323-00001					0.26	0.41	0.52	62	N					
	with applied grilles	PEL-N-257-00322-00002					0.25	0.37	0.46	62		NC				

R-Value = 1/U-Factor
 SHGC = Solar Heat Gain Coefficient
 VLT % = Visible Light Transmission
 CR = Condensation Resistance
 ER = Canadian Energy Rating

U.S. Glazing performance values are calculated based on NFRC 100, NFRC 200 and NFRC 500. ENERGY STAR® values are updated to 2023 (version 7) criteria.
 The Canadian values shown are based on the updated ENERGY STAR® 2020 initiative.
 For center-glass values, see the Product Performance section.
 Visit www.energystar.gov for Energy Star guidelines.

Climate Zones

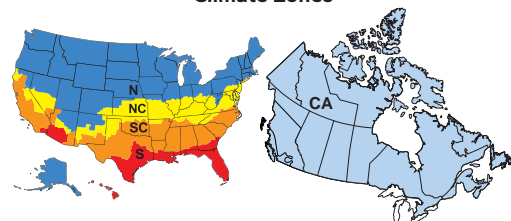



Grilles

Grille Profiles

Grilles-Between-the-Glass

3/4" Contour GBG

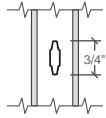

1" Dual-Pane

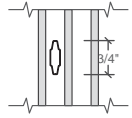

1-1/4" Triple-Pane

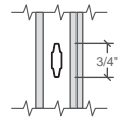

1" Impact-Resistant

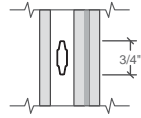

1-1/4" Impact-Resistant

Applied Grilles

1-5/8" Applied SDL

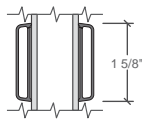

1" Dual-Pane

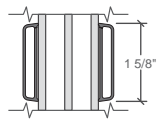

1-1/4" Triple-Pane

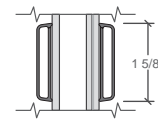

1" Impact-Resistant

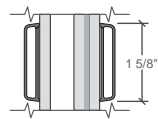

1-1/4" Impact-Resistant

Grille Patterns

Grilles-Between-the-Glass

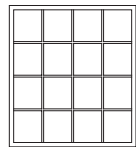

Traditional

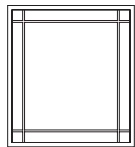

9-Lite Prairie₁

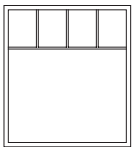

Top Row₂

- (1) Standard corner lite dimension for Prairie patterns = 4" visible glass (VG).
- (2) Standard visible glass to center line of separator bar = 14" or half of total visible glass height, whichever is smaller. Multiple rows are available up to 50% glass size.

Applied Grilles (to simulate multiple unit composites)

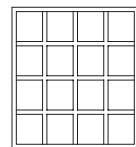

4 x 4

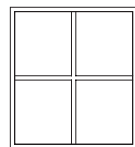

2 x 2

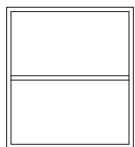

1 x 2

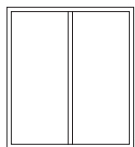

2 x 1

Equally Divided

- Select up to 4 lites wide or high

Unequally Divided

- Custom Specify - select up to 3 lites wide or high

Top Row

- Select desired number of lites wide. Horizontal bar height is variable up to 50% glass size.

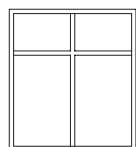

2 x 2

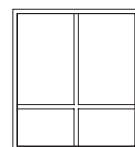

2 x 2

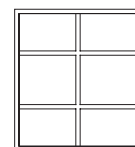

2 x 3

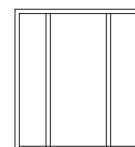

3 x 1

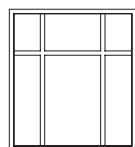

3 x 2

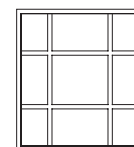

3 x 3

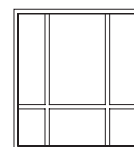

3 x 2

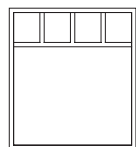

4 x 1

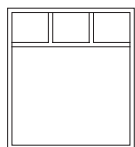

3 x 1

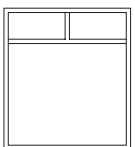

2 x 1

The above are examples only and are not to scale.



Impervia® Fixed Frame Windows

Design Data - Special Sizes and Dimensions

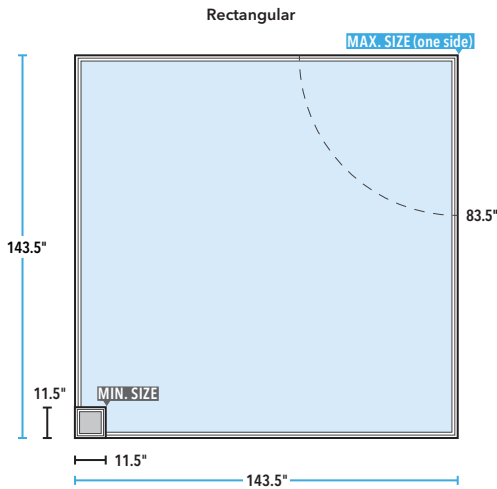

Single unit

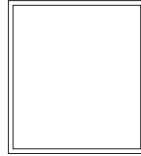

Minimum
11-1/2" W x 11-1/2" H
(292 x 292)

Maximum
11' 11-1/2"
(143-1/2")
(3 645)

In one direction
Short side cannot be > 83.5"
70 Ft² Maximum

General Notes:

- To convert areas to square meters (m²), multiply square feet by 0.0929.
- Rough Opening = Frame Dimension + 1/2".
- Keep frame dimensions to the nearest 1/8" increment

A composite is a window or door consisting of two or more sashes or panels within a single frame utilizing an integral mullion. Integral mullions are not impact certified.

2-Wide Composite with Integral Mullion

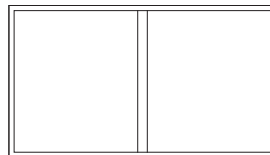

Minimum
1' 11-1/2" W x 11-1/2" H
(23-1/2" x 11-1/2")
(597 x 292)

Maximum
11' 11-1/2" W or 6' 11-1/2" H
(143-1/2" x 83-1/2")
(3 645 x 2 121)

70 Ft² Maximum

3-Wide Composite with Integral Mullion

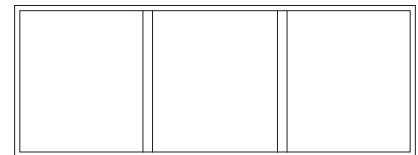

Minimum
2' 11-1/2" W x 11-1/2" H
(35-1/2" x 11-1/2")
(902 x 292)

Maximum
11' 11-1/2" W or 6' 11-1/2" H
(143-1/2" x 83-1/2")
(3 645 x 2 121)

70 Ft² Maximum

Glass Formulas

	Actual Glass		Visible Glass	
	Width	Height	Width	Height
Single units	Frame Width – 2.25"	Frame Height – 2.25"	Frame Width – 3.5"	Frame Height – 3.5"

When ordering and sizing composites, use overall frame/rough opening dimension.

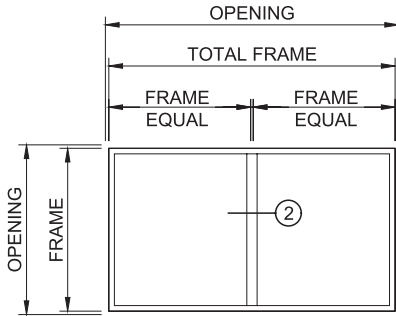

② 2-Wide Fixed Frame with Integral Mullion

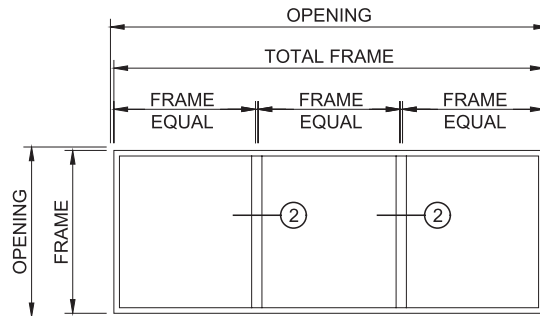

② 3-Wide Fixed Frame with Integral Mullion

Fixed Frame Direct Set Dimensions

Overall Composite ₁	Opening Width		Opening Height		Frame Width		Frame Height	
	Minimum	Maximum	Minimum	Maximum	Minimum	Maximum	Minimum	Maximum
2-Wide	2' (24") (610)	12' (144") (3 658)	1' (12") (305)	7' (84") (2 134)	1' 11-1/2" (23-1/2") (597)	11' 11-1/2" (143-1/2") (3 645)	11-1/2" (292)	6' 11-1/2" (83-1/2") (2 121)
3-Wide	3' (36") (914)	12' (144") (3 658)	1' (12") (305)	7' (84") (2 134)	2' 11-1/2" (35-1/2") (902)	11' 11-1/2" (143-1/2") (3 645)	11-1/2" (292)	6' 11-1/2" (83-1/2") (2 121)

(1) Keep frame dimensions to nearest 1/8" increments.

Maximum composite frame size should be no more than 70 sq. ft.

When ordering and sizing composites, use overall frame/rough opening dimension.

Integral mullions are not impact certified.



Impervia® Fixed Frame Windows

Design Data - Impact-Resistant Laminated Glass

Impact-resistant laminated glass will only be available on single units using Block Frame with a Prep for Screw Through Frame or Installation Clips attachment methods. Composite units do not qualify. See FPAS documents or Pella Installation Instructions for required anchor layout and details.

Impact-Resistant Performance Data

	1-1/4" SGP	1" PVB	1-1/4" PVB
Maximum Performance Grade¹			
Up to 18 sq. ft. of frame	+50 / -55	+50 / -55	+50 / -55
Up to 31 sq. ft. of frame	+50 / -55	+50 / -55	+50 / -55
Up to 48 sq. ft. of frame	+50 / -55	+50 / -55	+50 / -55
Certification			
Hallmark	411-H-1507	411-H-1507	411-H-1507
FPAS / TDI ₂	FL 26584	FL 26584	FL 26584

The use of fixed frame direct set windows is limited by product performance rating, design pressure load chart, installation method and glass thickness or type. Always consult local building code and Florida FPAS for performance and installation requirements.

Impact-Resistant Special Size Frame Dimensions

	Minimum	Maximum PVB	Maximum SGP
Fixed	11-1/2" W x 11-1/2" H (292 x 292)	2' 11-1/2" W x 6' 1-1/2" H (37-1/2" x 73-1/2") (902 x 1 867)	5' 0" W x 10' 0" H (60" x 120") (1 524 x 3 048)

Available within size range shown.
Keep frame dimensions to the nearest 1/8" increment.

All units with Impact-Resistant glazing are certified for wind zone 2, large missile rating C (Non-HVHZ).

(1) Maximum design pressure limited by unit testing or ASTM E 1300-04(H) and ASTM E 1300-04(D)

(2) Some size exclusions may apply.



Detailed Product Description

Frame

- Frame is Duracast® fiberglass composite — five-layer pultruded fiberglass material [with optional foam insulation¹], reinforced with a Pella patented interlocking mat.
- Overall frame depth is 3-1/4".
- Nominal wall thickness of Duracast fiberglass composite members is .070" to 0.135" thick.
- Frame corners are mitered, joined and bonded with corner lock, mechanical fasteners and with injected polyurethane adhesive sealant.
- Jamb contain factory-positioned installation screw locations.
- Optional factory-applied jamb extensions available in 4-9/16" and 6-9/16".

Exterior / Interior

- Duracast fiberglass composite surfaces with powder-coat paint finish.
 - Color is [White] [Brown] [Black] [Tan] [Morning Sky Gray].
 - or -
 - Dual-color option [Brown] [Black] [Tan] [Morning Sky Gray] exterior with White interior.

Glazing System

- Quality float glass complying with ASTM C 1036.
- Glazing Serviceability [Exterior and Interior access required - Wet glaze PUR sealant] [Interior access only required - Dry glaze foam tape]
- Dual-pane 1" insulating glass [[annealed] [tempered]] [obscure₂], [[clear] [Advanced] [SunDefense™] [SunDefense+] [AdvancedComfort] [NaturalSun] [NaturalSun+] Low-E coated, with argon]] [[bronze] [gray] [green] Advanced Low-E [with Argon]] sealed and bonded to frame.
- High altitude glazing available.
- or -
- Triple-Pane 1-1/4" insulating glass [[annealed] [tempered]] [obscure₂] [clear] [[Advanced] [NaturalSun] Low-E coated [with argon]]
- or -
- Open glaze also available – frame, glass stops, glass stop covers only.

Impact-Resistant

- Silicone-glazed 1-1/4" dual-seal impact-resistant insulating glass SGP. [[tempered] [annealed]] exterior light is [[Advanced Low-E] [SunDefense] [clear] [bronze] [gray] [green]]. Laminated clear interior light.
- or -
- Silicone-glazed [1] [1-1/4"] dual-seal impact-resistant insulating glass [PVB]. [[tempered] [annealed]] exterior light is [[Advanced Low-E] [SunDefense] [clear]]. Laminated [clear] interior light, or [[tempered] [annealed]] exterior light is [multi-layer Low-E]. Laminated [[bronze] [gray] [green]] interior light.

Optional Foam Insulation Inserts¹

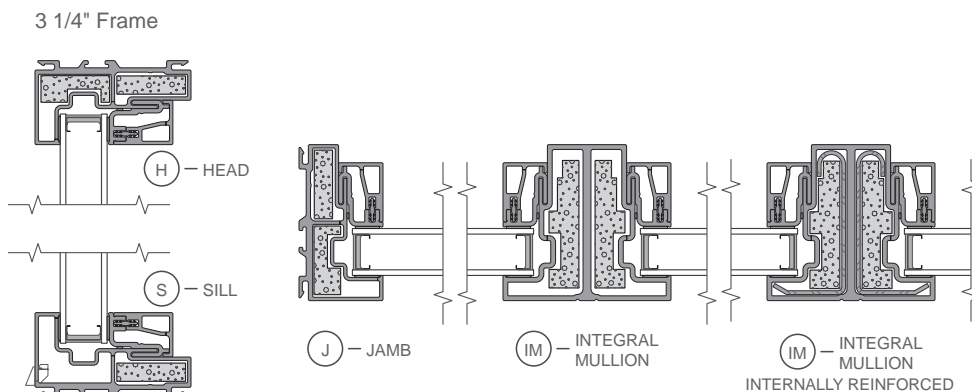

(1) Foam insulation inserts are not available with clear glazing.
 (2) Obscure glazing is not available when AdvancedComfort Low-E coated IG is specified.

Optional Products

Grilles

- Grilles-Between-the-Glass
 - Insulating glass contains 3/4" contoured aluminum grilles permanently installed between two panes of glass.
 - Grilles are factory pre-finished [White] [Brown] [Black] [Tan] [Morning Sky Gray].
- Interior and Exterior Applied grilles
 - 1-5/8" aluminum grilles are applied to the interior and exterior of glass.
 - Grilles are factory pre-finished [White] [Brown] [Black] [Tan] [Morning Sky Gray].



Impervia® Fixed Frame Windows

Unit Sections - Frame Types and Glazing Options

NEW CONSTRUCTION FRAME

Standard Block Frame with Standard Fin

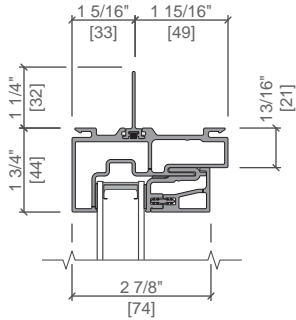

Standard Block Frame with Off Set Fin

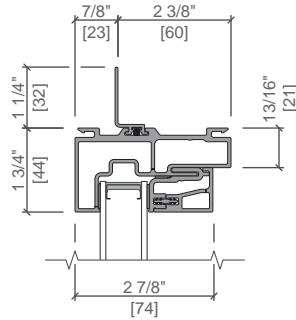

REPLACEMENT FRAME

Standard Block Frame

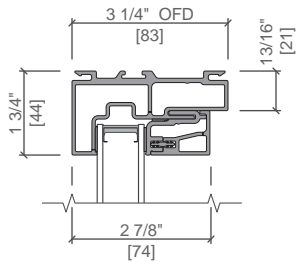

GLAZING OPTIONS

1" Dual IG

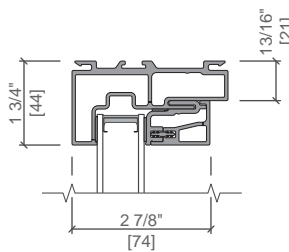

1" Sound IG

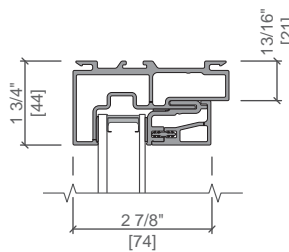

1" Impact-Resistant IG

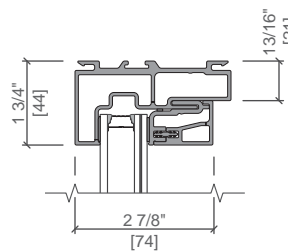

1 1/4" Triple IG

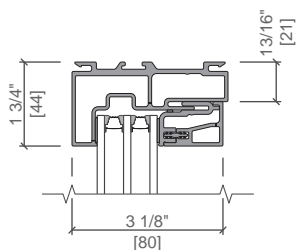

1 1/4" Impact-Resistant IG

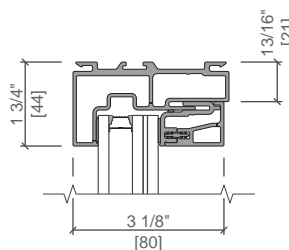

Scale 3" = 1' 0"

All dimensions are approximate.



Impervia® Fixed Frame Windows

Unit Sections - Dual-Pane

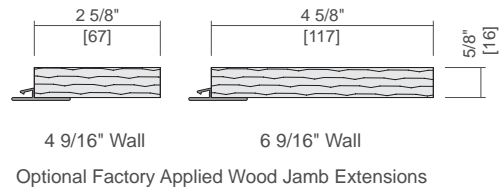
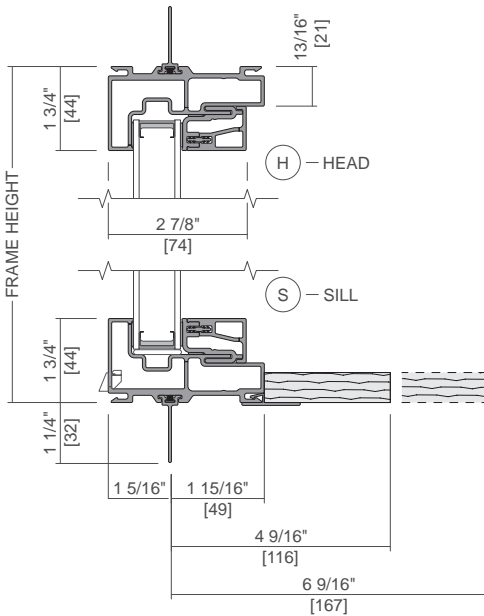
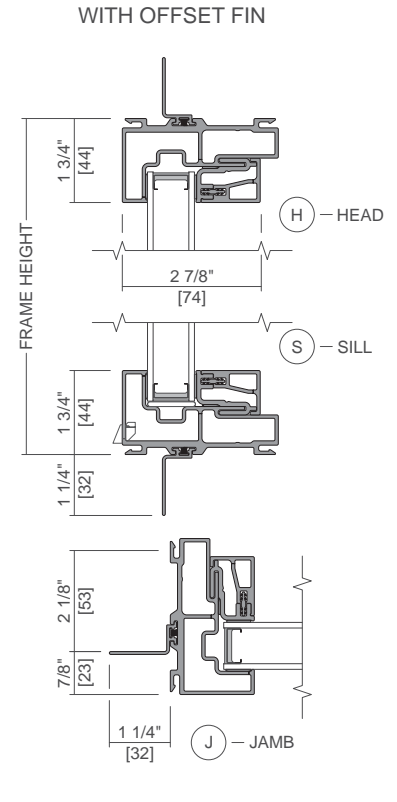
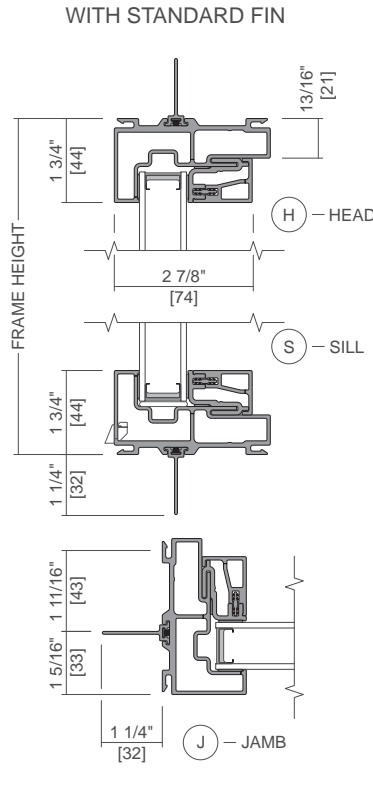
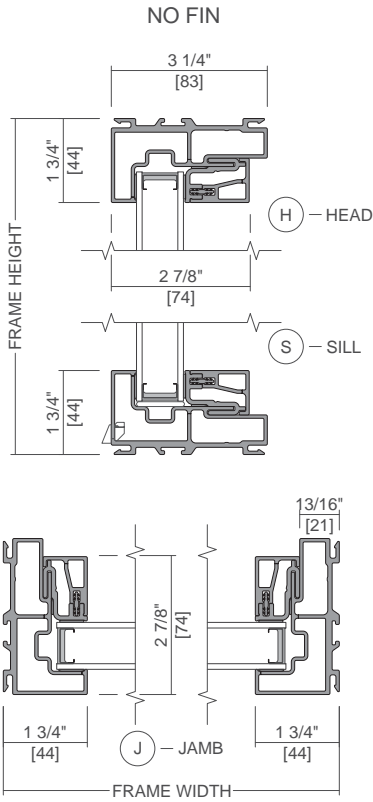
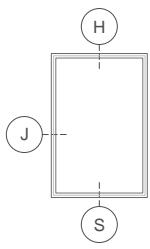

Scale 3" = 1' 0"

All dimensions are approximate.



Impervia® Fixed Frame Windows

Unit Sections - Dual-Pane Composites

TWO WIDE
HORIZONTAL UNIT

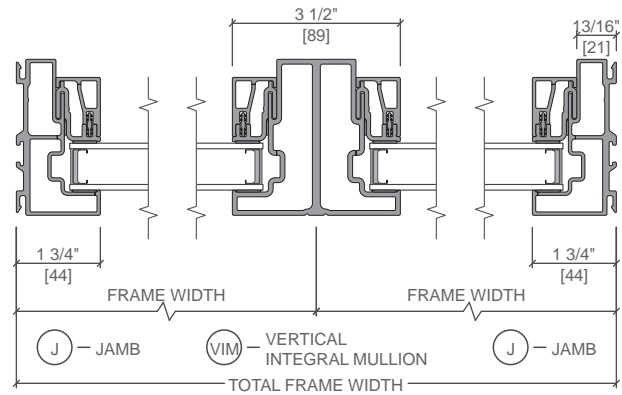
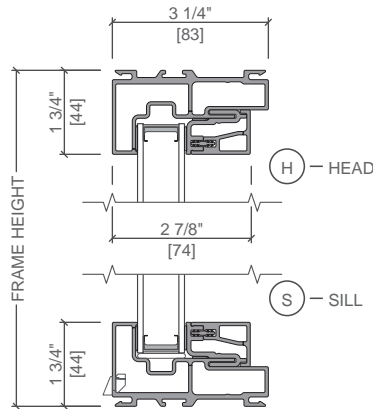
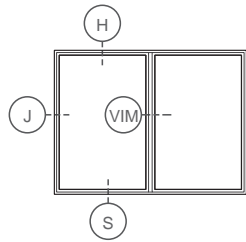

THREE WIDE
HORIZONTAL UNIT

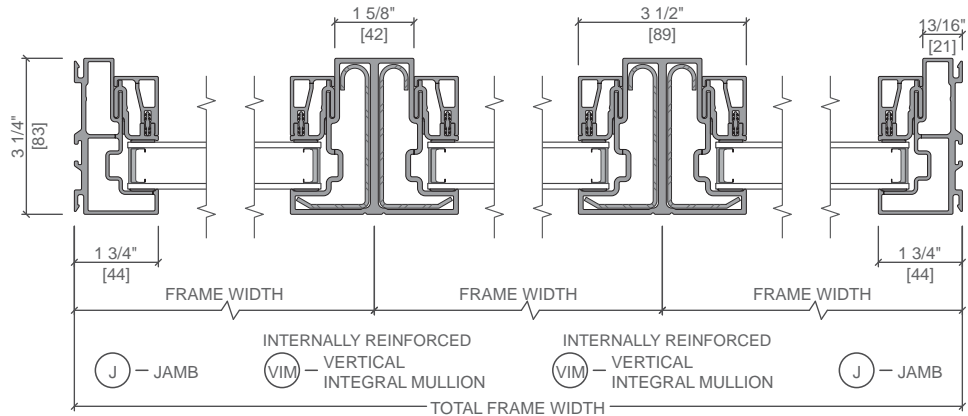
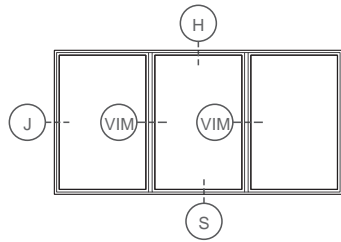

COMBINATION

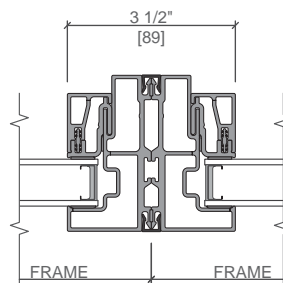

JOINING MULLION
WITH TAPE
(Vertical Only)

Scale 3" = 1' 0"

All dimensions are approximate.

See the Combinations section for mullion applications and structural limitations.

Integral mullions are not impact certified.



Impervia® Fixed Frame Windows

Unit Sections - Triple-Pane

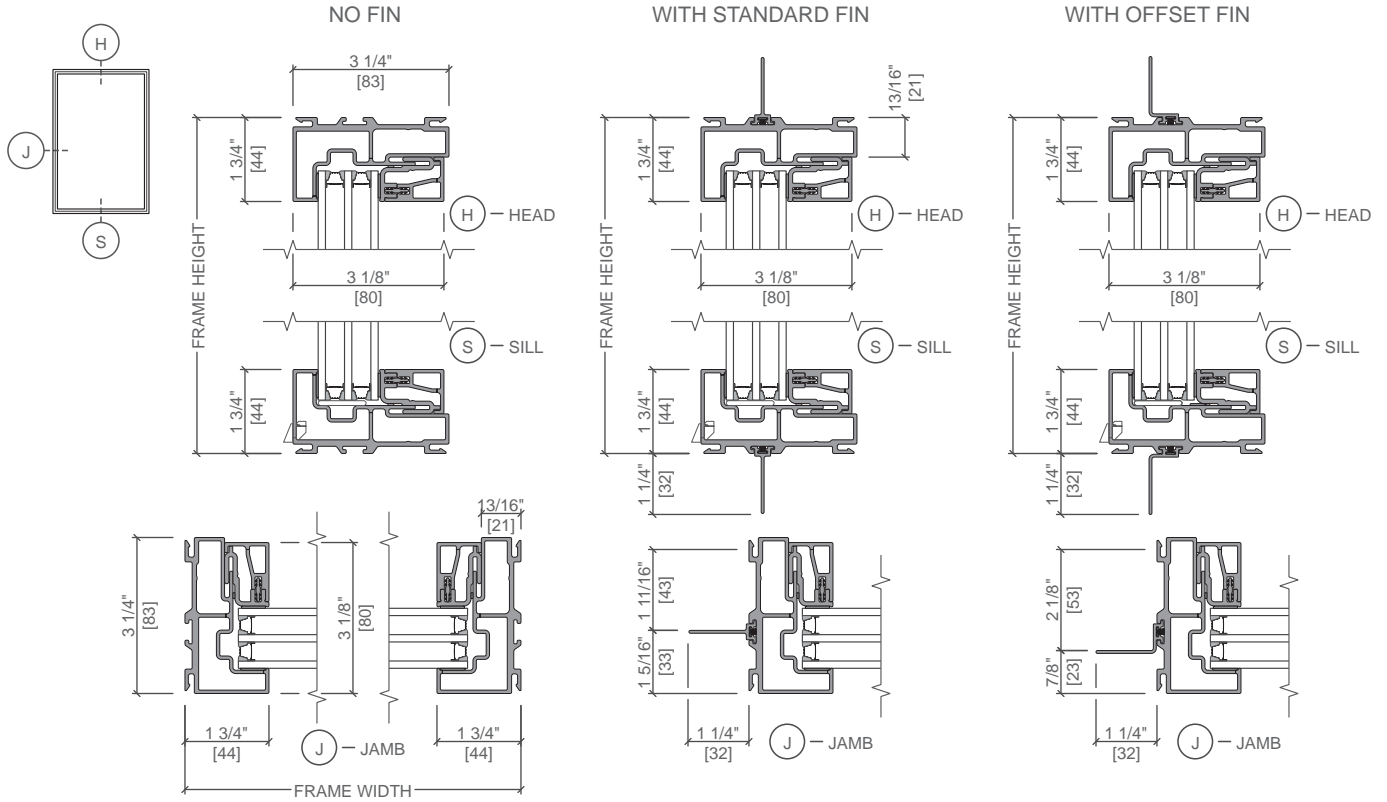

Scale 3" = 1' 0"

All dimensions are approximate.



Impervia® Fixed Frame Windows

Unit Sections - Triple-Pane Composites

TWO WIDE HORIZONTAL UNIT

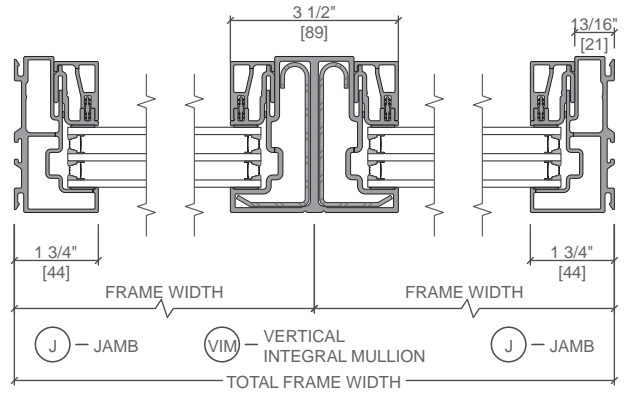
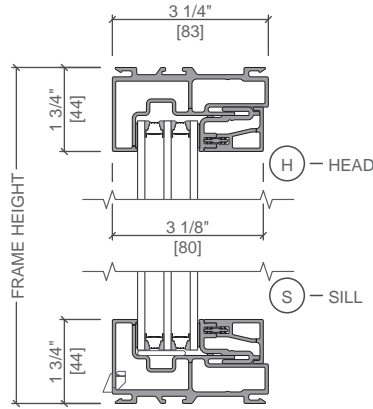
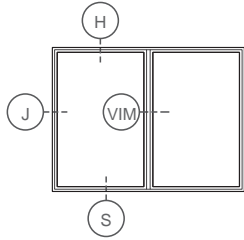

THREE WIDE HORIZONTAL UNIT

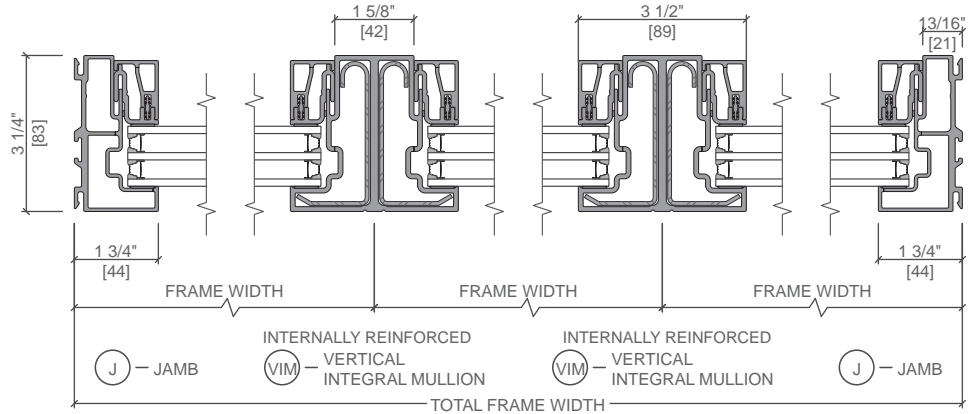
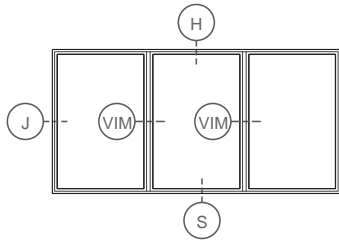

Scale 3" = 1' 0"

All dimensions are approximate.

See the Combinations section for mullion applications and structural limitations.

Integral mullions are not impact certified.



Impervia® Fixed Frame Windows

Unit Sections - Impact-Resistant Laminated Glass

1" IMPACT-RESISTANT IG

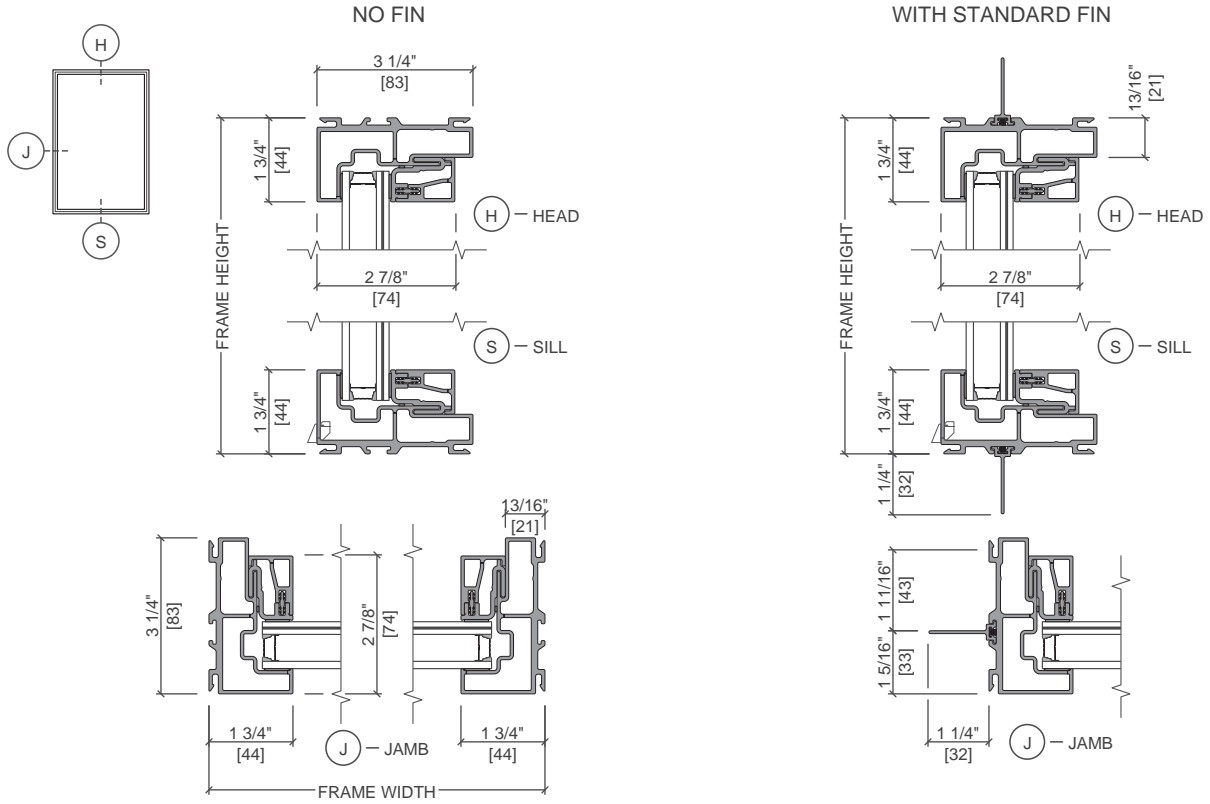

1 1/4" IMPACT-RESISTANT IG

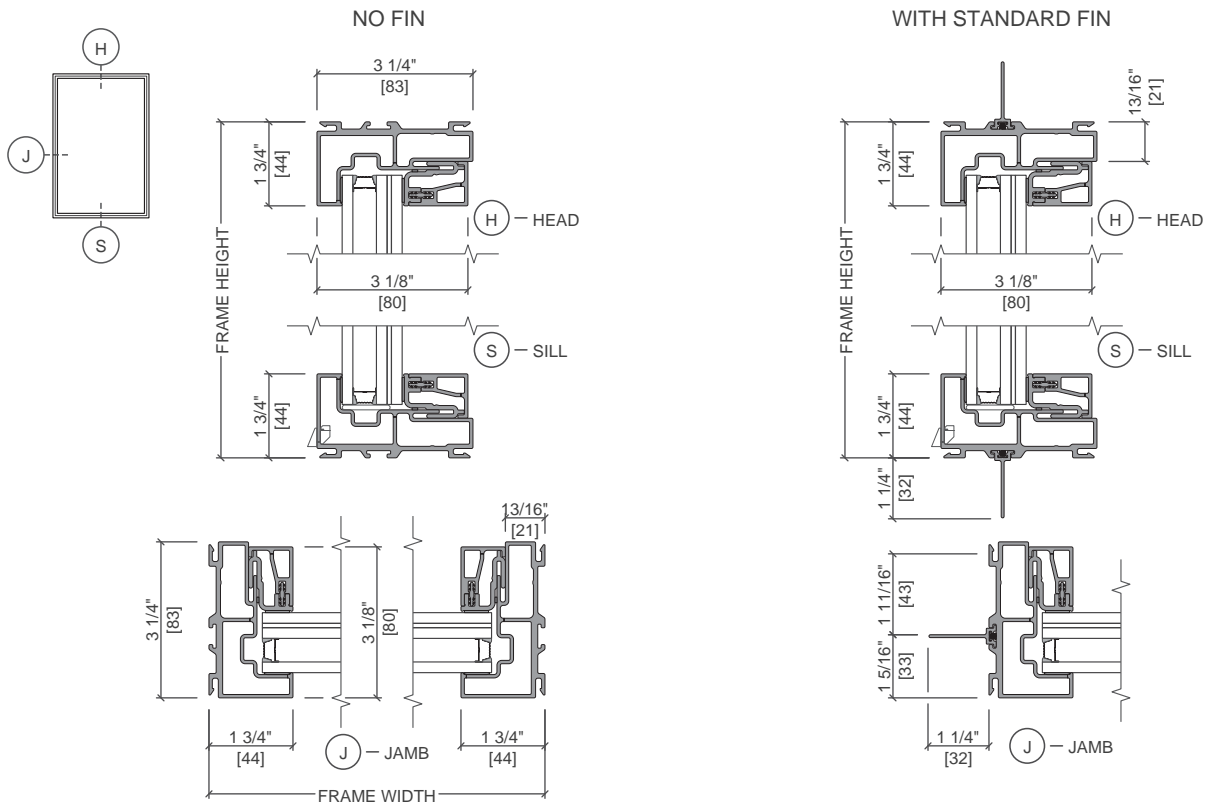

Scale 3" = 1' 0"

All dimensions are approximate.

rev. 10/01/2023