



General Information

Definitions V-CR-2

Design Considerations..... V-CR-2

Composite Configurations V-CR-4

Design Considerations and Examples for Typical Window and Door Combinations..... V-CR-5

Recommendations..... V-CR-6

 Single Unit Opening..... V-CR-6

 Horizontal Window (Two-Way Vertical Joint)..... V-CR-7

 Vertical Window (Two-Way Horizontal Joint)..... V-CR-8

 Three-Way Window V-CR-9

 Four-Way Window V-CR-10

 Sliding Door (Two-Way Joint)..... V-CR-11

Sample Calculations..... V-CR-12

 Door and Window Typical Combinations V-CR-12

 Horizontal and Vertical Typical Combinations..... V-CR-14

Reinforcing Mullion Joint Load Table V-CR-16

The information published in this document is believed to be accurate at the time of publication. However, because we are constantly working to improve our products, specifications are subject to change without notice. Consult your local Pella representative for up-to-date product information.



Definitions

This section explores requirements and limitations related to mulling various combinations of vinyl windows and doors.

Important:

Determining and meeting the structural load requirements and design of the rough opening is the responsibility of the architect or engineer. Window and door frame systems are not designed to support additional elements or components of the building wall system.

Specific accessories and construction details must address the various conditions that are critical for the proper design of a horizontal combination of windows (ribbon windows) and vertical combination (stacked windows) such as:

- Proper flashing
- Control joints to accommodate expansion and contraction
- Intermediate structural support

Encompass by Pella® vinyl window products are intended only for use less than 40 feet above ground level.

| Definitions: | |
|--------------------------------------|---|
| Combination | An assembly formed by two or more separate windows, window composites, or doors whose frames are mullied together using a combination joining mullion or reinforcing mullion. |
| Combination (Joining) Mullion | A horizontal or vertical member formed by joining two or more individual window or door units together without a mullion stiffener. |
| Composite | A window or door consisting of two or more sash in one frame utilizing an integral mullion. |
| Integral Mullion | A horizontal or vertical member which is bounded at either end or both ends by a crossing frame member. |
| Reinforcing Mullion | A horizontal or vertical member with an added continuous mullion stiffener and joining two or more individual windows or doors along the sides of the mullion stiffener. |



The following steps are provided as a guide to assist in properly integrating Pella products and accessories into combination assemblies. Sample calculations based on these steps are on pages 12 through 15.

1. Determine the overall size configuration and nominal unit sizes of the combination. Windows or doors within the combination may be fixed or venting.

2. Determine the required wind load (design pressure).

The design pressure is the wind load pressure that the window assembly is to withstand. The required design pressure is determined by the project engineer or architect however can also be provided by the local code official.

ASCE 7, Minimum Design Loads for Buildings and Other Structures, contains the generally accepted method for determining design pressure for components and cladding based on building size and shape, geographical location, topographical factors, building use and location on the building's surface.

3. Determine if the individual windows composites and/or doors within the assembly meet the required design pressure.

Each Pella window, composite and door is rated to withstand a certain level of wind loading. The design pressure determined in step 2 should also be used to specify window and door performance. The Product Performance section on www.pella.com has more detailed information on the relationship between design pressure and the performance class and grade ratings used to specify window/door performance. See each product section for specific performance class and grade information for each unit used in the combination.

4. Determine if the combination will be factory assembled or non-factory assembled.

Use the reference information in this section to determine if the combination is available factory assembled. Also consider factors such as installation method, handling and accessibility to the opening. Conditions specific to the project may require that a combination be assembled in the opening.

5. Determine the requirement for reinforcing mullions.

Placing windows, composites and doors in an assembly creates joints or mullions that may need reinforcing and/or flashing requirements. In order to ensure that a given combination will withstand the design pressure determined in step 2, use the reinforcing load table on page 16. The reinforcing load table considers structural performance only. Performance class and grade ratings apply to single units, or composites only. See the Size and Performance Data page within each product section for more information. Also consider the dead load when placing windows over doors.

6. Determine the appropriate reinforcing mullion.

The reinforcement mullion load table on page D-16 is intended to aid in the selection of reinforcing members to help the combination resist the forces placed upon it by wind loads and loads caused by other units within the combination. Step 7 of the example on pages 12 and 15 (page numbers may need to change) provide instruction on how to use the table. By entering the table with the joint's mullion length and the widths of the adjacent units, choose the reinforcing mullion option at or below the coordinate given on the table. If a spread mullion is being used for aesthetic reasons, use the table to determine if the spread mullion is sufficient.

7. Determine rough opening and window size data.

This section contains recommendation pages for each assembly type. Use the recommendations in this section to determine rough opening clearance dimensions. Add any applicable mullion dimensions to arrive at the overall opening dimensions.

The combination assembly design example on pages 12 through 15 shows how these steps may be followed to design a combination assembly.



Composite Configurations

Not all composite units are AAMA/WDMA performance certified. See the appropriate design data tables in the window product sections for performance class and grade information. Composites are available in window types and configurations shown below. See the product sections for complete details.

Composite Configurations

Double-Hung

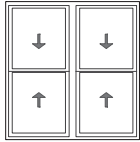

2-Wide Vent

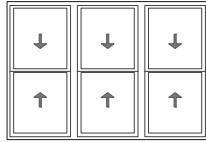

3-Wide Vent

Single-Hung

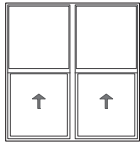

2-Wide Vent

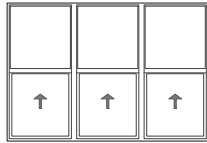

3-Wide Vent



Fixed with Flanker



Transom over 1-Wide

Sliding Window

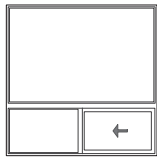

Fixed Over XO or OX

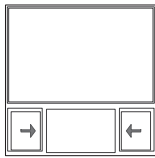

Fixed Over XOX

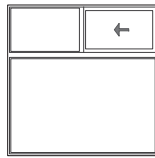

XO or OX Over Fixed



Combinations

Many typical unit combinations are available factory assembled. Go to the Combination Size Data Section, for the complete details. All factory assembled combinations are two-way mullions and have a performance class and grade rating of R20. Pella recommends factory assembly of combinations where ever possible. Combination with two-way mulls may be field assembled. All three-way and four-way mullion joints require reinforcing mullions.

Typical Configurations

Typical Window Combinations

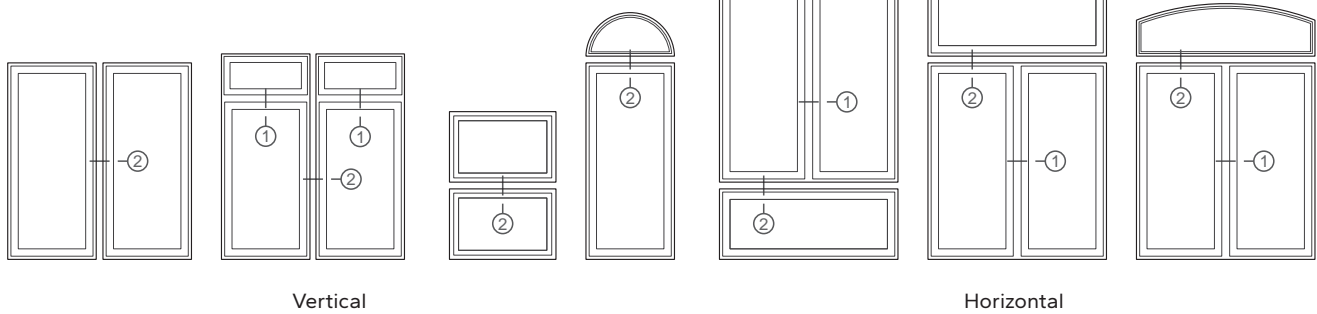

Typical Door Combinations

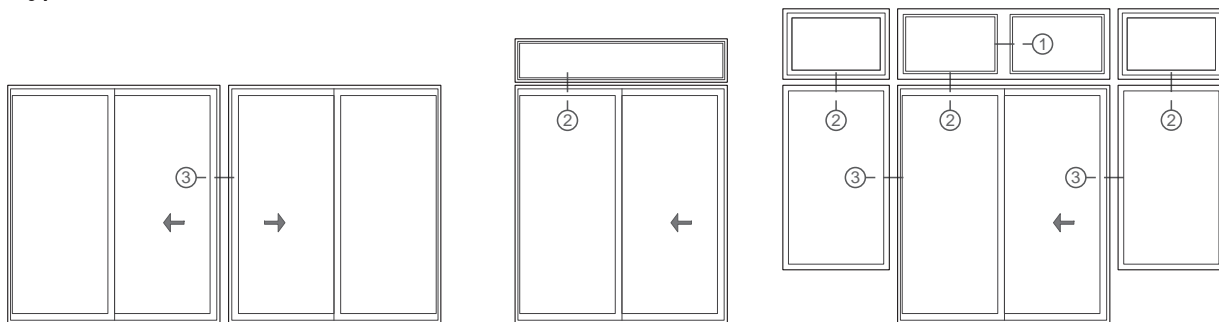

- ① Integral Mullion (composite)
- ② Combination (Joining) Mullion or Reinforcing Mullion
- ③ Reinforcing Mullion required



Encompass by Pella® Combination Recommendations

Typical Sealant Details - Opening Recommendations

Proper sealant placement is critical to window or door performance. See typical exterior and interior perimeter sealant details below.

When apply siding, brick veneer or other exterior finish material, leave adequate space between the unit frame and the exterior finish material for backer rod and sealant.

Special Note—The sealant details shown are standard recommendations from the sealant industry. Contact your sealant supplier for recommendations and instruction for this or any other application.

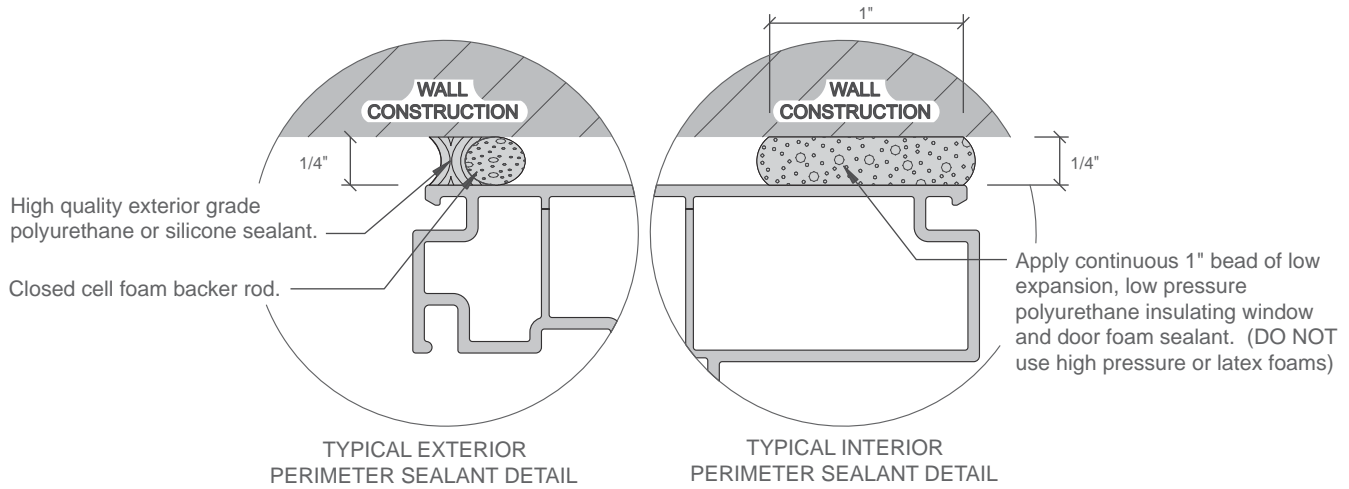

Single Unit Opening Recommendations – Windows

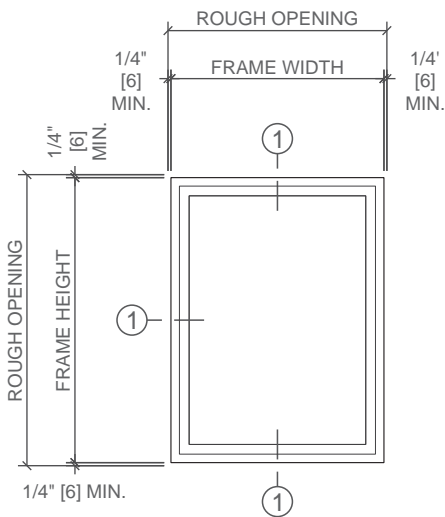

These recommendations apply to typical individual and composite windows.

① Rough openings for typical installations, are to be 1/2" wider than frame width and 1/2" taller than the frame height. For large size units, and/or in masonry construction, the need for additional rough opening clearances should be reviewed.

Determine if unit performance meets design requirements. Unit Performance Class and Grade information is shown in each product section.

See typical exterior and interior perimeter sealant details above. Proper sealant placement is critical to window performance.



Encompass by Pella® Combination Recommendations

Two-Way Vertical Joint Recommendations and Parameters

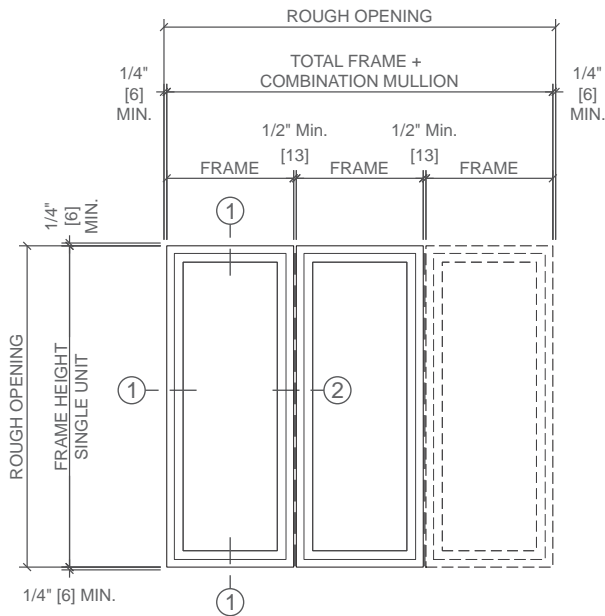

These recommendations apply to a typical horizontal combination of any vent or fixed unit. Each unit may be a single or composite unit.

See the instructions provided with the mullion kit for complete mullion assembly information.

Refer to single-unit opening recommendations in addition to the following:

① Minimum 1/4" clearance on smaller openings. Minimum 1/2" clearance is recommended at each jamb for openings with three windows.

② If Design Pressure exceeds 20 psf, a reinforcing mullion is required. See the mullion load chart on page 16.

Proper sealant placement is critical to window performance. See sealant details on page 6.

Vinyl Vertical Combination (Joining) Mullion Parameters (Windows)

H-Bar Combination (Joining) Mullion - 2-11/16" Frame Depth

Maximum Design Pressure: 20 psf

Horizontal and Vertical combination (joining) mullions may not be used in the same combination.

2-11/16" frame depth only.

Maximum of three (3) windows or composites in one combination

Maximum combination frame height = 71-1/2"

Rough Opening Maximum:

Field Assembled: 50 Sq. Ft.

Factory Assembled: See size charts in combination size data section.

1/2" Combination (Joining) Mullion

Maximum Design Pressure: 20 psf

Horizontal and Vertical combination (joining) mullions may not be used in the same combination.

Units being mullied must be the same frame depth.

Maximum of three (3) windows or composites in one combination

Maximum combination frame height = 96"

All mullions 53-1/2" or longer must be reinforced with a minimum 1/4" x 3" 6061-T6 aluminum flat bar reinforcement.

Rough Opening Maximum:

Field Assembled: 54 Sq. Ft.

Factory Assembled: See size charts in combination size data section.

All units must have interior and exterior accessory groove and the same frame depth.

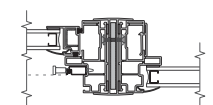

H-Bar Mullion with Aluminum Flatbar

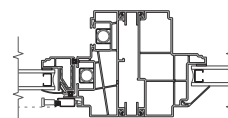

1/2" Mullion Cover

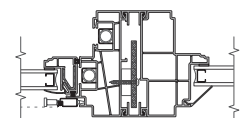

1/2" Mullion Cover with Aluminum Flatbar



Encompass by Pella® Combination Recommendations

Two-Way Horizontal Joint Recommendations and Parameters

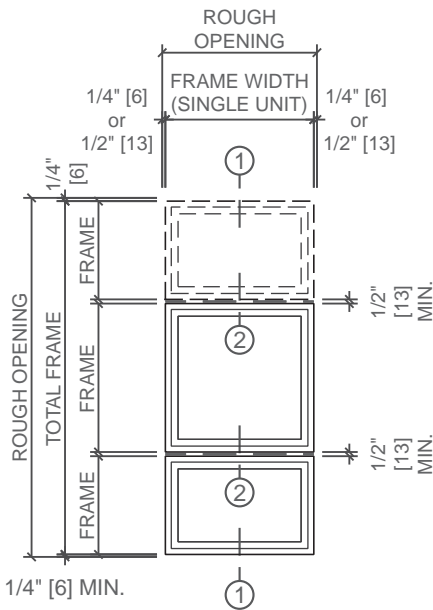

These recommendations apply to typical vertical stacking of vent or fixed units of the same width to a maximum height of 8' 11-1/2" without intermediate support.

Each unit may be a single or composite unit.

See the instructions provided with the mullion kit for complete mullion assembly information.

Refer to single-unit opening recommendations in addition to the following:

- ① Minimum 1/4" clearance on small openings. 1/2" clearance is recommended at opening with three (3) windows.
- ② Stacked units to be mullied together using the combination (joining) mullion prior to placing the windows in the rough opening. If Design Pressure exceeds 20 psf, a reinforcing mullion is required (See mullion load chart on page 16).

Proper sealant placement is critical to window performance.

See sealant details on page 6.

Vinyl Horizontal Combination (Joining) Mullion Parameters (Windows)

H-Bar Combination (Joining) Mullion - 2-11/16" Frame Depth

Maximum Design Pressure: 20 psf

Horizontal and Vertical combination (joining) mullions may not be used in the same combination.

2-11/16" frame depth only.

Maximum of three (3) windows or composites in one combination

Maximum combination frame height = 107-1/2"

Maximum mullion length = 95-1/2"

Rough Opening Maximum:

Field Assembled: 50 Sq. Ft.

Factory Assembled: See size charts in combination size data section.

Single-Hung only: Maximum single unit width = 35-1/2"

1/2" Combination (Joining) Mullion

Maximum Design Pressure: 20 psf

Horizontal and Vertical combination (joining) mullions may not be used in the same combination.

Units being mullied must be the same frame depth.

Maximum of three (3) windows or composites in one combination

Maximum combination frame height = 107-1/2"

Maximum mullion length = 96"

Rough Opening Maximum:

Field Assembled: 50 Sq. Ft.

Factory Assembled: See size charts in combination size data section.

All mullions 53-1/2" or longer must be reinforced with a minimum 1/4" x 3" 6061-T6 aluminum flat bar reinforcement.

All units must have interior and exterior accessory groove.

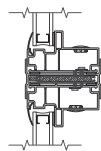

H-Bar Combination (joining) Mullion with Aluminum Flat bar

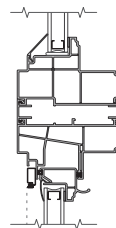

1/2" Combination (joining) Mullion Cover



1/2" Combination (joining) Mullion Cover with Aluminum Flat bar



3-Way Window Recommendations and Parameters

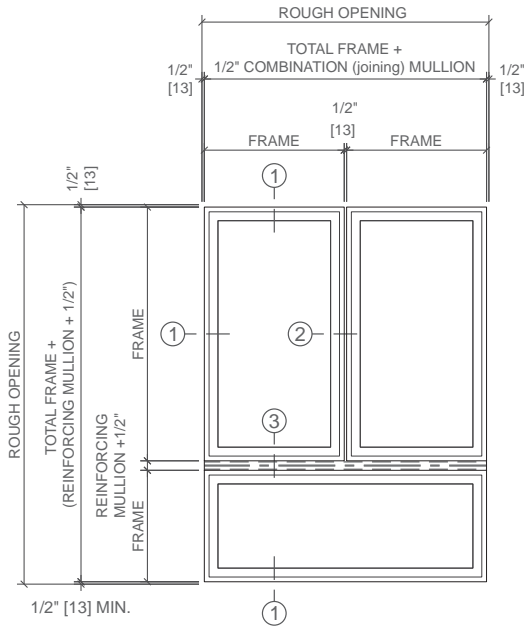

These recommendations apply to a typical grouping of any two vent or fixed units over one fixed unit that forms a three-way mullion intersection.

Refer to single-unit opening recommendations in addition to the following:

- ① 1/2" clearance is recommended at head, jambs and sill.
- ② 1/2" combination (joining) mullion. If design pressure exceeds 20 psf, a reinforcing mullion is required. See mullion load chart on page 16.
- ③ Reinforcing mullion is required. (See mullion load chart on page 16).

See page 7 for vertical 1/2" combination (joining) mullion parameters.

Proper sealant placement is critical to window performance.

See sealant details on page 6.



4-Way Window Joint Recommendations and Parameters

4-Way combinations may be configured in one of the following ways:

- a) Two combination (joining) mullions and one reinforcing mullion.
- b) Three reinforcing mullions.

These recommendations apply to a typical grouping of any combination of window units that form a four-way mullion intersection.

Refer to single-unit opening recommendations in addition to the following:

- ① 1/2" clearance is recommended at head, jambs and sill.
- ② 1/2" combination (joining) mullion. If design pressure exceeds 20 psf, a reinforcing mullion is required. See mullion load chart on page 16.
- ③ All four-way mullion intersections require reinforcing mullion in one direction (either vertically or horizontally, see mullion load chart on page 16).

See page 7 for vertical combination (joining) mullion parameters and page 8 for horizontal combination (joining) mullion parameters.

Proper sealant placement is critical to window performance. See sealant details on page 6.

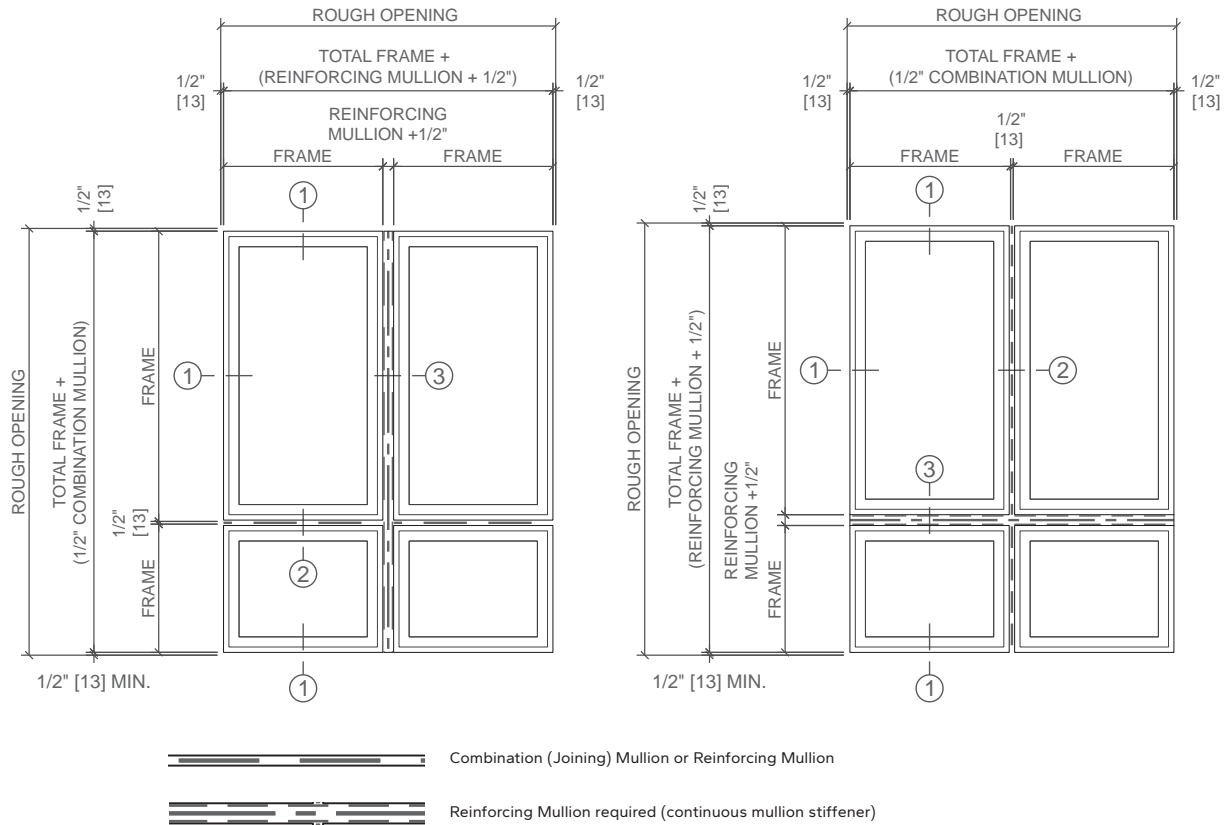



Encompass by Pella® Combination Recommendations

Sliding Door 2-Way Horizontal Joint Recommendations and Parameters

These recommendations apply to a typical combination of any vent or fixed unit.

- ① Minimum 1/4" clearance at jambs and 1/2" at head. Minimum 1/2" clearance is recommended at each jamb for openings with three units.
- ② If Design Pressure exceeds 20 psf, a reinforcing mullion is required. See the mullion load chart on page 16.

Proper sealant placement is critical to window performance. See sealant details on page 6.

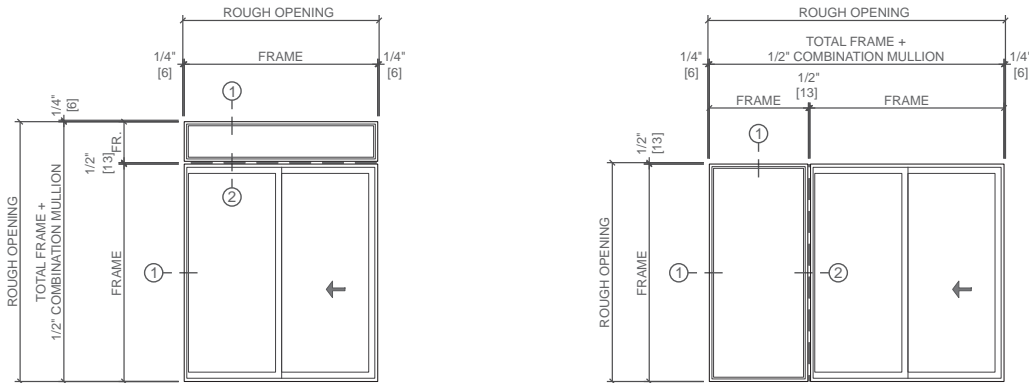

Vinyl Combination (Joining) Mullion Parameters (Doors)

1/2" Horizontal Combination (Joining) Mullion

Maximum Design Pressure: 20 psf
 Horizontal and Vertical combination (joining) mullions may not be used in the same combination.
 Units being mullied must be the same frame depth.
 Mullions must be reinforced a minimum 1/4" x 3" 6061-T6 aluminum flat bar reinforcement.
Rough Opening Maximum:
 Field Assembled: 50 Sq. Ft.
 Factory Assembled: See size charts in combination size data section.
 All units must have interior and exterior accessory groove.

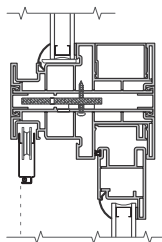

1/2" Combination (joining)
 Mullion Cover
 with Aluminum Flatbar
 @ Transom

1/2" Vertical Combination (Joining) Mullion

Maximum Design Pressure: 20 psf
 Horizontal and Vertical combination (joining) mullions may not be used in the same combination.
 Units being mullied must be the same frame depth.
 Mullions must be reinforced a minimum 1/4" x 3" 6061-T6 aluminum flat bar reinforcement.
Rough Opening Maximum:
 Field Assembled: 50 Sq. Ft.
 Factory Assembled: See size charts in combination size data section.
 Sidelights may not be mullied to the lock side door jamb.
 All units must have interior and exterior accessory groove.

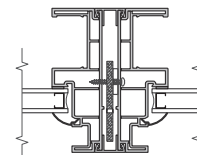

1/2" Combination (joining)
 Mullion Cover
 with Aluminum Flatbar
 @ Sidelight



Encompass by Pella® Combination Recommendations

Door and Window Typical Combinations - Sample Calculations

Sample Calculations: (Based on steps 1-7 on pages 2 and 3)

1. Determine the overall size configuration and nominal unit sizes of the combination:

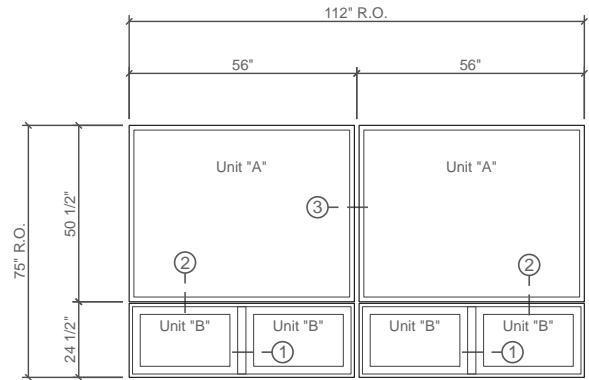

- ① Integral Mullion
- ② Mullion type to be determined
- ③ Mullion type to be determined

2. Determine the required windload (design pressure):

Project description:

Location: Pella, IA

Based on in ASCE 7-16, Minimum Design Loads for Buildings and Other Structures

Wind speed = 109 mph, Exposure C

Design Pressure: 20 psf

3. Determine performance of window/door size and performance (nominal sizing):

NOTE: Window and door sizes may need to be adjusted in step 9 to allow for mullion widths.

Individual Window Performance: Unit A (See chart 1-Wide Fixed below)

Project design pressure: 20 psf

Required window/door performance class and grade rating: R20

Applicable Product – Fixed Window

Individual window size and performance:

4'8" x 4'3" – Performance Class and Grade = F-R25 (Go to next larger unit in size table)

Individual Window Performance: Unit B (See chart 2-Wide Vent Composites with Integral Mullion below)

Project design pressure: 20 psf

Required window/door performance class and grade rating: R20

Applicable Product – 2-Wide Awning Window Composite with Integral Mullion.

4'8" x 2'0" – Performance Class and Grade = AP-R35 (Go to next larger unit in size table)

Result: Selected windows meet design pressure requirements.

1-Wide Fixed (Unit A)

| Call Out | Frame | | Visible Glass Ft ² | Frame Area Ft ² | Performance Class & Grade |
|----------|----------------|-----------------|-------------------------------|----------------------------|---------------------------|
| | Width (Inches) | Height (Inches) | | | |
| 2-0/4-0 | 23-1/2 | 47-1/2 | 5.5 | 7.8 | F-R25 |
| 2-0/4-6 | 23-1/2 | 53-1/2 | 6.3 | 8.7 | F-R25 |
| 2-0/5-0 | 23-1/2 | 59-1/2 | 7.1 | 9.7 | F-R25 |
| 3-0/4-0 | 35-1/2 | 47-1/2 | 9.1 | 11.7 | F-R25 |
| 3-0/4-6 | 35-1/2 | 53-1/2 | 10.4 | 13.2 | F-R25 |
| 3-0/5-0 | 35-1/2 | 59-1/2 | 11.7 | 14.7 | F-R25 |
| 4-0/4-0 | 47-1/2 | 47-1/2 | 12.7 | 15.7 | F-R25 |
| 4-0/4-6 | 47-1/2 | 53-1/2 | 14.4 | 17.6 | F-R25 |
| 4-0/5-0 | 47-1/2 | 59-1/2 | 16.2 | 19.6 | F-R25 |
| 5-0/4-0 | 59-1/2 | 47-1/2 | 16.2 | 19.6 | F-R25 |
| 5-0/4-6 | 59-1/2 | 53-1/2 | 18.5 | 22.1 | F-R25 |
| 5-0/5-0 | 59-1/2 | 59-1/2 | 20.8 | 24.6 | F-R25 |

2-Wide Vent Composites with Integral Mullion (Unit B)

| Call Out | Frame | | Vent Area Ft ² | Visible Glass Ft ² | Frame Area Ft ² | Performance Class & Grade ₁ |
|----------|----------------|-----------------|---------------------------|-------------------------------|----------------------------|--|
| | Width (Inches) | Height (Inches) | | | | |
| 4-0/1-6 | 47-1/2 | 17-1/2 | 3.3 | 3.0 | 5.8 | AP-R35 |
| 4-0/2-0 | 47-1/2 | 23-1/2 | 4.9 | 4.7 | 7.8 | AP-R35 |
| 4-0/2-6 | 47-1/2 | 29-1/2 | 6.6 | 6.4 | 9.7 | AP-R35 |
| 4-0/3-0 | 47-1/2 | 35-1/2 | 8.3 | 8.2 | 11.7 | AP-R35 |
| 6-0/1-6 | 47-1/2 | 17-1/2 | 5.3 | 4.8 | 5.8 | AP-R35 |
| 6-0/2-0 | 47-1/2 | 23-1/2 | 7.9 | 7.5 | 7.8 | AP-R35 |
| 6-0/2-6 | 47-1/2 | 29-1/2 | 10.6 | 10.2 | 9.7 | AP-R35 |
| 6-0/3-0 | 47-1/2 | 35-1/2 | 13.2 | 12.9 | 11.7 | AP-R35 |
| 8-0/1-6 | 95-1/2 | 17-1/2 | 7.2 | 6.5 | 11.6 | AP-R35 |
| 8-0/2-0 | 95-1/2 | 23-1/2 | 10.9 | 10.2 | 15.6 | AP-R35 |
| 8-0/2-6 | 95-1/2 | 29-1/2 | 14.5 | 13.9 | 19.6 | AP-R35 |
| 8-0/3-0 | 95-1/2 | 35-1/2 | 18.2 | 17.7 | 23.5 | AP-R35 |

Continued on next page



Encompass by Pella® Combination Recommendations

Door and Window Typical Combinations - Sample Calculations

4. Determine if the combination will be factory assembled or non-factory assembled.

For this example, portions of the combination may be factory assembled and some are non-factory assembled.

5. Determine mullion types and reinforcement requirements:

Windload (lateral loading) YES If yes, joint type: Joint ① = two-way joint

Joint ② = four-way joint

6. Determine the appropriate reinforcing mullion: (See pages 2 through 6 in this section for notes and parameters)

Determine applicable combinations.

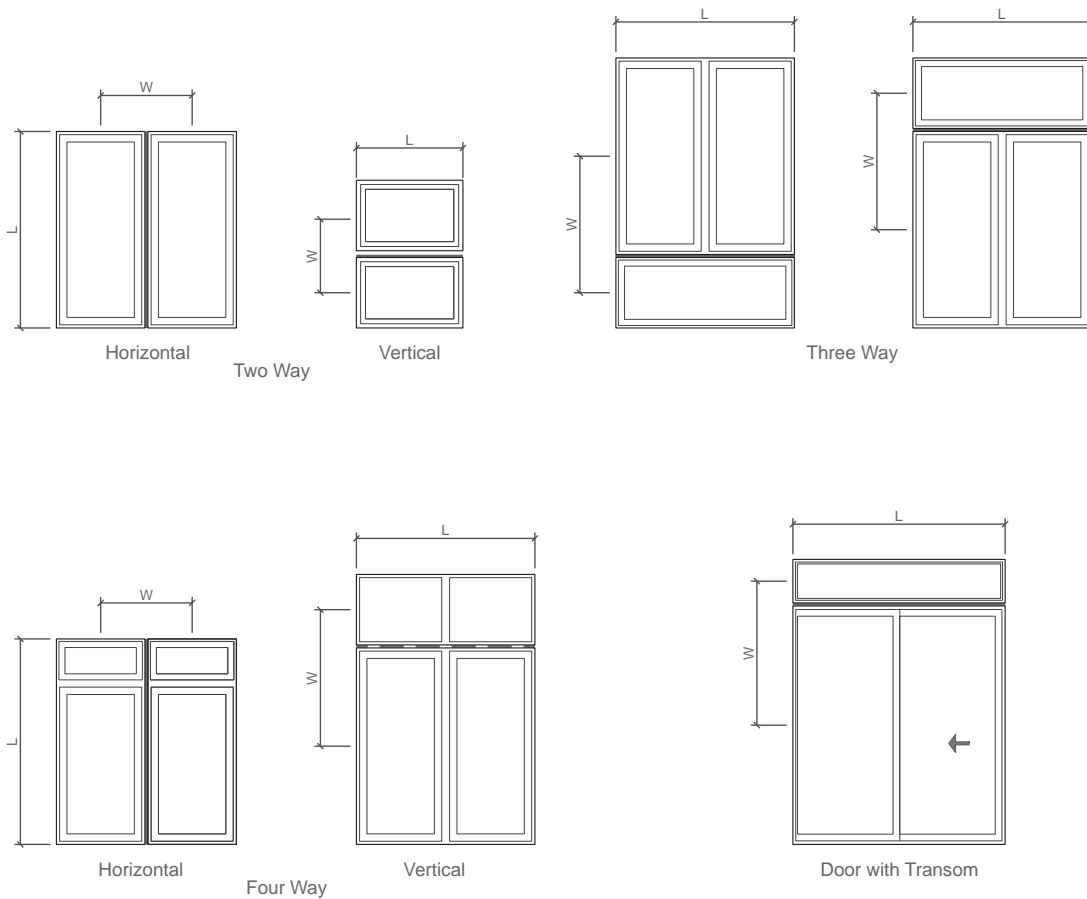

Continued on next page



Encompass by Pella® Combination Recommendations

Sample Calculations

Horizontal Mullion ②:

Option A: Because the Design Pressure is 20 psf or less, a Standard Combination (joining) Mullion may be used for joint ②. May be factory assembled combination or field assembled. See the Combination Size Data section to determine if the combination is available factory assembled. Factory assembled is recommend. (See page 8 for horizontal mullion parameters).

Option B: Determine reinforcing mullion for joint ②

Note: If the Standard Combination (joining) Mullion is not desired due to weight and/or handling concerns, this example shows the steps to follow to determine an appropriate field reinforcing million.

A. Determine L (Mullion length in inches) (Opening width x .5)

B. Determine W (Windload width in inches)

- a.) 1/2 the distance from the mullion to the member below = 12
- b.) 1/2 the distance from the mullion to the member above = 25-1/2

C. Determine minimum reinforcing mullion required (reference table below)

(Complete reinforcing mullion table is located on page 16)

Step 1 Enter the graph at the point of the mullion length (L).

Step 2 Move to the loading width (W).

Step 3 Move right to the column with the design pressure.

Joint ②

56"
37-1/2"

Use 60"
Use 55"
Use 20 psf

Reinforcing mullion results:

Joint ②: A = 2-2X4 wood studs.

| | | Design Pressure (PSF) | | | | |
|--------|--------|-----------------------|----|----|----|----|
| L (in) | W (in) | 20 | 25 | 30 | 35 | 40 |
| 48 | 80 | A | A | A | A | A |
| 48 | 90 | A | A | A | A | A |
| 48 | 100 | A | A | A | A | A |
| 60 | 55 | A | A | A | A | A |
| 60 | 60 | A | A | A | A | A |
| 60 | 65 | A | A | A | A | A |
| 60 | 70 | A | A | A | A | B |

Vertical Mullion ③:

Determine reinforcing mullion for joint ③

A. Determine L (Mullion length in inches) (Rough Opening Height)

B. Determine W (Windload width in inches)

- a.) 1/2 the distance from the mullion to the member left = 28
- b.) 1/2 the distance from the mullion to the member right = 28.

C. Determine minimum reinforcing mullion required (reference table below)

(Complete reinforcing mullion table is located on page D-16)

Step 1 Enter the graph at the point of the mullion length (L).

Step 2 Move to the loading width (W).

Step 3 Move right to the column with the design pressure.

Joint ③

75"
56"

Use 84"
Use 60"
Use 20 psf

Reinforcing mullion results:

Joint ③: B = (2)-18 ga 1-3/8" x 3-5/8" Steel Studs

| | | Design Pressure (PSF) | | | | |
|--------|--------|-----------------------|----|----|----|----|
| L (in) | W (in) | 20 | 25 | 30 | 35 | 40 |
| 84 | 40 | A | A | B | B | B |
| 84 | 45 | A | A | B | B | B |
| 84 | 50 | A | B | B | B | B |
| 84 | 55 | A | B | B | B | B |
| 84 | 60 | B | B | B | B | B |
| 84 | 65 | B | B | B | B | B |
| 84 | 70 | B | B | B | B | B |



Encompass by Pella® Combination Recommendations

Sample Calculations

7. Determine actual rough opening and window size data:

Width (Option A and Option B):

| | |
|--|--------------|
| Rough Opening Width | 112" |
| Deduct jamb clearance (1/2" X 2) | -1" |
| Deduct vertical reinforcing mullion width | -2-3/4" |
| Deduct clearance at reinforcing mullion (1/4" X 2) | <u>-1/2"</u> |
| Total window frame width | 107-3/4" |
| Total window frame width ÷ 2 | 53-7/8" |

Height (Option A):

| | |
|---|--------------|
| Rough Opening Height | 75" |
| Deduct head and sill clearance (1/2" X 2) | -1" |
| Deduct combination (joining) mullion | <u>-1/2"</u> |
| Total window frame height | 73-1/2" |

(use 50" for top unit and 23-1/2" for lower unit)

Height (Option B):

| | |
|--|--------------|
| Rough Opening Height | 75" |
| Deduct head and sill clearance (1/2" X 2) | -1" |
| Deduct horizontal reinforcing mullion width | -3" |
| Deduct clearance at reinforcing mullion (1/4" X 2) | <u>-1/2"</u> |
| Total window frame height | 70-1/2" |

(use 47" for top unit and 23-1/2" for lower unit)

Final Layout and Detail:

Option A

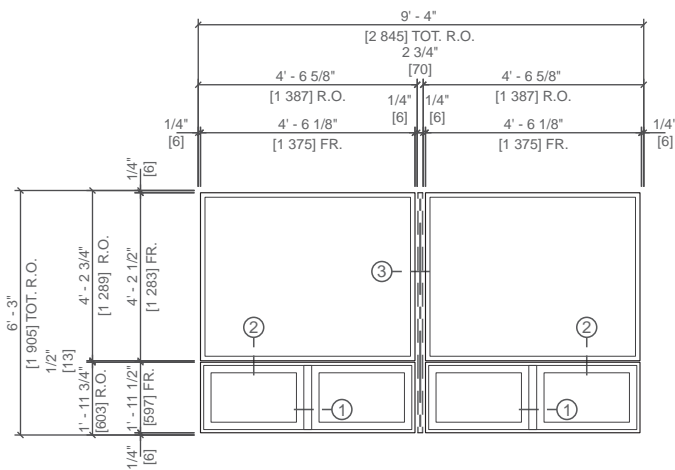

Option B

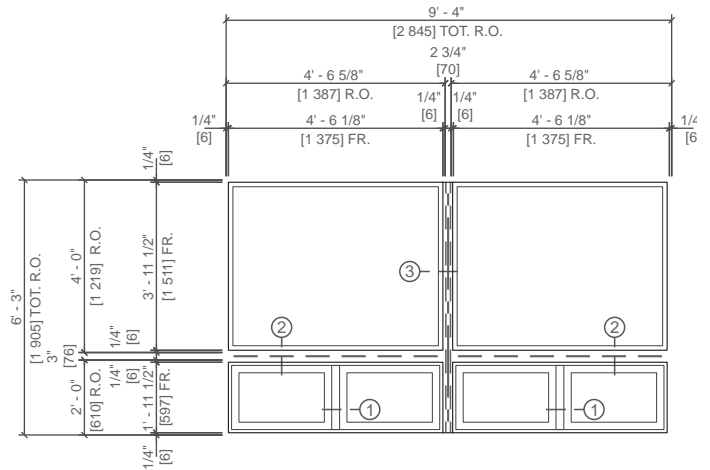

- ① Integral Mullion (composite)
- ② Combination (Joining) Mullion factory assembled recommended) or field assembled
- ③ Reinforcing Mullion required (continuous)

- ① Integral Mullion (composite)
- ② Reinforcing Mullion
- ③ Reinforcing Mullion required (continuous)

NOTE: To allow for use of standard unit sizes, rough opening or mullion dimensions may need to change. If the rough opening dimension increases, recheck the reinforcing mullion.



Encompass by Pella® Combination Recommendations

Joint Load Table for Windows and Doors - Field Installed Only

| Design Pressure (PSF) | | | | | | | | | |
|-----------------------|--------|----|----|----|----|----|-----|-----|--|
| L (in) | W (in) | 20 | 25 | 30 | 35 | 40 | 45 | 50 | |
| 36 | 54 | B | B | B | B | B | B | B | |
| 36 | 60 | B | B | B | B | B | B | B | |
| 36 | 66 | B | B | B | B | B | B | B | |
| 36 | 72 | B | B | B | B | B | B | C | |
| 36 | 80 | B | B | B | B | B | C | C | |
| 36 | 84 | B | B | B | B | B | C | C | |
| 36 | 96 | B | B | B | B | C | C | C | |
| 48 | 30 | B | B | B | B | B | B | B | |
| 48 | 36 | B | B | B | B | B | B | B | |
| 48 | 42 | B | B | B | B | B | B | C | |
| 48 | 48 | B | B | B | B | C | C | C | |
| 48 | 54 | B | B | B | B | C | C | C | |
| 48 | 60 | B | B | B | C | C | C | C | |
| 48 | 66 | B | B | C | C | C | C | C | |
| 48 | 72 | B | B | C | C | C | C | C | |
| 48 | 80 | B | C | C | C | C | C | E | |
| 48 | 84 | B | C | C | C | C | C | E | |
| 48 | 96 | C | C | C | C | E | E | F | |
| 60 | 24 | B | B | B | B | B | B | B | |
| 60 | 30 | B | B | B | B | B | C | C | |
| 60 | 36 | B | B | B | C | C | C | C | |
| 60 | 42 | B | B | C | C | C | C | C | |
| 60 | 48 | B | B | C | C | C | C | C | |
| 60 | 54 | B | C | C | C | C | C | E | |
| 60 | 60 | B | C | C | C | C | E | E | |
| 60 | 66 | C | C | C | C | E | E | F | |
| 60 | 72 | C | C | C | E | E | F | F | |
| 60 | 80 | C | C | C | E | F | F | F | |
| 60 | 84 | C | C | E | E | F | F | F | |
| 60 | 96 | C | C | E | F | F | F | F | |
| 72 | 24 | B | B | B | B | C | C | C | |
| 72 | 30 | B | B | C | C | C | C | C | |
| 72 | 36 | B | C | C | C | C | C | E | |
| 72 | 42 | B | C | C | C | C | E | F | |
| 72 | 48 | C | C | C | C | E | F | F | |
| 72 | 54 | C | C | C | E | F | F | F | |
| 72 | 60 | C | C | E | F | F | F | F | |
| 72 | 66 | C | C | E | F | F | F | F | |
| 72 | 72 | C | E | F | F | F | F | F | |
| 72 | 80 | C | E | F | F | F | F | F | |
| 72 | 84 | C | F | F | F | F | F | K | |
| 72 | 96 | E | F | F | F | F | K | K | |
| 84 | 24 | B | C | C | C | E | E | E | |
| 84 | 30 | C | C | C | C | E | E | E | |
| 84 | 36 | C | C | C | E | E | F | F | |
| 84 | 42 | C | C | E | E | F | F | F | |
| 84 | 48 | C | E | E | F | F | F | F | |
| 84 | 54 | C | E | F | F | F | F | F | |
| 84 | 60 | E | E | F | F | F | F | F | |
| 84 | 66 | E | F | F | F | F | F | K | |
| 84 | 72 | E | F | F | F | F | K | K | |
| 84 | 80 | F | F | F | F | K | K | K | |
| 84 | 84 | F | F | F | F | K | K | K | |
| 96 | 24 | C | C | C | E | E | E | F | |
| 96 | 30 | C | C | E | E | F | F | F | |
| 96 | 36 | C | E | E | F | F | F | F | |
| 96 | 42 | E | E | F | F | F | F | F | |
| 96 | 48 | E | F | F | F | F | F | K | |
| 96 | 54 | E | F | F | F | F | K | K | |
| 96 | 60 | F | F | F | F | K | K | K | |
| 96 | 66 | F | F | F | F | K | K | K | |
| 96 | 72 | F | F | F | K | K | K | N/A | |
| 108 | 24 | C | E | E | E | F | F | F | |
| 108 | 30 | E | E | E | F | F | F | F | |
| 108 | 36 | E | E | F | F | F | F | H | |
| 108 | 42 | E | F | F | F | F | K | K | |
| 108 | 48 | F | F | F | F | K | K | K | |
| 108 | 54 | F | F | F | K | K | K | K | |
| 108 | 60 | F | F | H | K | K | K | N/A | |
| 108 | 66 | F | F | K | K | K | N/A | N/A | |

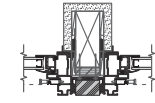

B - 2 x 4 Nominal Wood

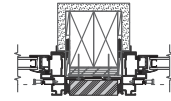

C - (2)- 2 x 4 Nominal Wood

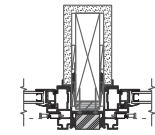

E - 2 x 6 Nominal Wood

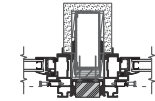

F - 20 ga 1-3/8" x 3-5/8" Steel Stud

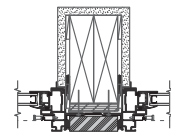

H - (2)- 2 x 6 Nominal Wood

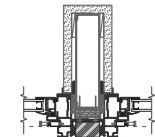

K - 20 ga 1-3/8" x 6" Steel Stud

- All reinforcing mullions must be properly secured at ends. Wall framing around window opening must be adequate to withstand wind loads transferred from window combinations and reinforcing mullions.
- Do not use these accessories or mullions for structural vertical loading. Reinforcing mullions are for wind loading only.
- Design charts are not valid for locations where impact forces from airborne debris must be considered.
- If mullion length or load factor exceed chart values, please contact your local Pella sales representative.