

IMPORTANT SAFETY AND PRODUCT INFORMATION – DOORS

Safety Alert Symbol Reference: These symbols are intended to alert you to potential injury hazards and information. Obey all safety messages.

**COULD
Result in:**



**COULD
Result in:**



**COULD
Result in:**



**COULD
Result in:**



To ensure safety and security and help prevent property damage, including possible damage to your door, close and lock windows and doors any time they are not being used for venting on a nice day, and particularly during high winds or rain.



Many doors in older homes are painted with lead-based paint. Removal of old doors may disturb this paint. Proper precautions must be taken to minimize exposure to dust and debris. Consult state or local authorities and/or go to www.epa.gov/lead for more information.

NOTICE Pella products must be stored in an upright, level position not exposed to weather. The storage must be ventilated and provide protection from direct sunlight and excessive temperature.

IMPORTANT NOTICE Because all construction must anticipate some water infiltration, it is important that the wall system be designed and constructed to properly manage moisture. Pella Corporation is not responsible for claims or damages caused by anticipated and unanticipated water infiltration; deficiencies in building design, construction and maintenance; failure to install Pella products in accordance with Pella's installation instructions; or the use of Pella products in wall systems which do not allow for proper management of moisture within the wall systems. The determination of the suitability of all building components, including the use of Pella products, as well as the design and installation of flashing and sealing systems are the responsibility of the Buyer or User, the architect, contractor, installer, or other construction professional and are not the responsibility of Pella.

Pella products should not be used in barrier wall systems which do not allow for proper management of moisture within the wall systems, such as barrier Exterior Insulation and Finish Systems (EIFS) (also known as synthetic stucco) or other non-water managed systems. Except in the states of California, New Mexico, Arizona, Nevada, Utah and Colorado, Pella makes no warranty of any kind on and assumes no responsibility for Pella windows and doors installed in barrier wall systems. In the states listed above, the installation of Pella Products in barrier wall or similar systems must be in accordance with Pella's installation instructions. Product modifications that are not approved by Pella Corporation will void the warranty.

CARE AND MAINTENANCE: Refer to the Pella Owner's Manual. Visit www.pella.com or your local retailer for more information.

CLEANING INSTRUCTIONS: Refer to the Pella Owner's Manual for comprehensive maintenance and cleaning information. Visit www.pella.com or your local retailer for more information.

NOTICE DO NOT apply any other types of film to the glass. Doing so could void product warranty.

NOTICE DO NOT use abrasives. DO NOT scrape or use tools that might damage the surface.

NOTICE DO NOT use inappropriate solvents or brickwash or cleaning chemicals. If you do, permanent damage can result and the product failure, loss or damage would not be covered by the Limited Warranty.

FINISHING INSTRUCTIONS (WOOD PATIO DOORS AND FIBERGLASS ENTRY DOORS): Paint or finish immediately after installation.

If products cannot be finished immediately, cover with clear plastic to protect from dirt, damage and moisture. Remove any construction residue before finishing. Sand all wood surfaces lightly with 180 grit or finer sandpaper. DO NOT use steel wool. BE CAREFUL NOT TO SCRATCH THE GLASS. Remove sanding dust. Pella products must be finished according to these instructions; failure to follow these instructions voids the Limited Warranty. Finishing panel edges is optional for Patio Doors.

NOTICE To maintain proper product performance do not paint, finish or remove the weatherstripping, mohair dust pads, gaskets or vinyl parts. Air and water leakage will result if these parts are removed. After finishing, allow venting Doors and doors to dry completely before closing them. If paint, stain or finish gets on the weatherstripping, wipe it off immediately with a damp cloth.

Panel Cleaning and Prep Instructions for Unfinished or Primed Panels: Dry wipe dust from doors gently. Examine door for possible smudges or fingerprints made from normal handling or construction. To remove smudges, lightly wipe surface with warm water. DO NOT sand surface of fiberglass panel. Scuff sand with light grade sand paper or abrasive pad (220 grit or higher). Rinse surface with mineral spirits for fiberglass panels and warm water for steel panels. Let door and sidelight surfaces dry completely before applying finish. Finish the door panels as soon as possible after installation.

STAINING FIBERGLASS PANELS OR UNFINISHED INTERIOR FRAME MEMBERS: Fiberglass door and sidelight panels may be stained with a gel stain if a wood look is desired. Pella offers stain kits in a variety of colors. Apply and finish per the stain kit manufacturer's instruction. Ensure that all exposed panel edges are finished to minimize the chance of damage.

Unprimed interior frame parts may be stained with wood stains and should be finished with a minimum of two coats of a clear polyurethane finish. DO NOT bridge the top coat between the outer edge of the glazing frame and the door panel.

Note: The fiberglass base color tone will vary. This variance is normal and will not impact the stain color of the door.

PAINTING INSTRUCTIONS: Wood door frame exteriors, premium steel door panels and sidelights are factory primed. Wood doors require painting immediately after installation. The factory applied primer is not intended for long term exterior exposure. Sand all un-primed interior wood surfaces lightly with 180 grit or finer sandpaper before priming and painting. Fiberglass door and sidelight panels do not require priming. Use two coats of a 100% latex paint that has a good blocking resistance. On units with glass, do not bridge paint between the outer edges of the glazing frame and the door panel. On fiberglass products, brush the paint in the same direction as the simulated wood grain. For entry doors, ensure that all exposed panel edges are finished to minimize the chance of panel damage. Finishing panel edges is optional for Patio Doors.

Pella Corporation is not responsible for interior paint and stain finish imperfections for any product that is not factory-applied by Pella Corporation. For additional information on finishing see the Pella Owner's Manual or go to www.pella.com.

NOTICE The use of unapproved finishes, solvents or cleaning chemicals may cause adverse reactions with door materials. Pella will not be responsible for problems caused by the use of unapproved materials. If in doubt, contact your local retailer or representative.

EXTERIOR FINISH OF EXISTING FRAME (POCKET REPLACEMENT): It is the responsibility of the homeowner, contractor or installer to ensure any exposed unfinished wood is covered or finished. Possible methods include, however are not limited to, covering with aluminum coil stock or painting.





FULL FRAME OR PANEL REMOVAL WHEN PREPARING TO INSTALL A NEW SLIDING DOOR







Many doors in older homes are painted with lead-based paint. Removal of old doors may disturb this paint. Proper precautions must be taken to minimize exposure to dust and debris. Consult state or local authorities for more information and/or go to www.epa.gov/lead for more information.

TOOLS REQUIRED:

- Utility knife 
- Phillips and Standard screwdrivers 

- Pry bar 
- Reciprocating saw 

- Hammer 
- Putty knife 

- Heat gun 
- Deglazing wheel 

- Angle grinder 

REMEMBER TO USE APPROPRIATE PERSONAL PROTECTIVE EQUIPMENT.

Apply adhesive film or duct tape to the glass to prevent breakage.

ALUMINUM PANEL AND/OR FRAME REMOVAL

- Score the paint or varnish between the interior trim and the wall or between the drywall return and the door frame to minimize damage. (Frame removal only).
- Remove the interior trim.
- Score the sealant or paint between the exterior siding or brick and the door frame.
- Remove the screen and vent panel from the old door. If it is not removable, see steps G-I.
- Remove the division bar by removing the screws at the ends or cutting it with a reciprocating saw.
- Remove the fixed panel. Remove any screws holding the fixed panel. Slide it and lift it out of the frame.

If the panels are not removable or the glass is sealed to the frame:

- Remove the glazing bead using a putty knife or small pry bar.
- For single pane doors with divided lights (grids). Use an angle grinder with a cut-off wheel to cut the end of the bars where they intersect with the sash or frame. This will allow the door glass to be removed more quickly.
- Heat the glazing seal using an electric heat gun.
- While applying heat, press a de-glazing wheel between the glass and panel or frame. Continue around the perimeter of the panel. Apply light, constant pressure to separate the glass from the panel or frame. Recycle or dispose of the glass properly.

Note: Wear appropriate personal protective equipment and keep the heat source away from flammable materials.

Stop here for pocket replacement, complete steps K-L for full frame replacement (Not applicable for flush flange pocket replacement).

- Cut through the frame using a reciprocating saw.
- Pry the frame away from the brick or siding. Use a block of wood under the pry bar to protect interior or exterior finishes. Dispose or recycle of the frame materials properly.

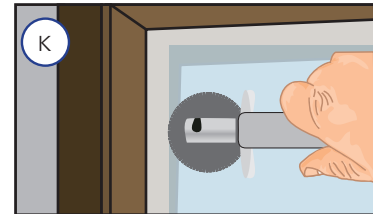
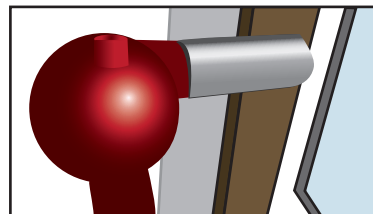
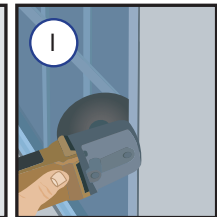
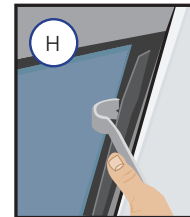
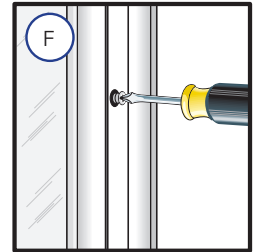
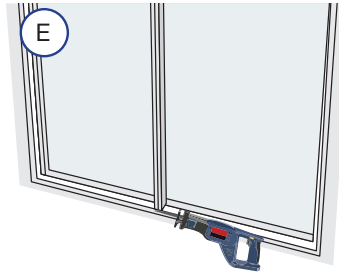
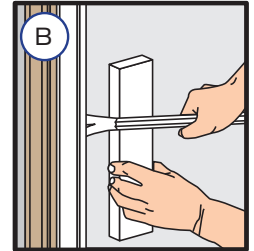

BRICKMOULD FRAME REMOVAL

- Score paint or varnish between the interior trim and the wall with a sharp utility knife.

Note: This will minimize the damage to the interior wall and trim.

- Remove the interior trim. Remove the interior trim from all the four sides of the door including the stool at the bottom of the door. If the interior trim is being reused, pull the nails out through the back side of the board with nipper pliers.

- Cut the exterior sealant line between the exterior brickmould or trim and the exterior siding or wall cladding.

- Remove the exterior brickmould or flat trim.

Remove hinge and strike screws.

Note: DO NOT disturb existing head flashings.



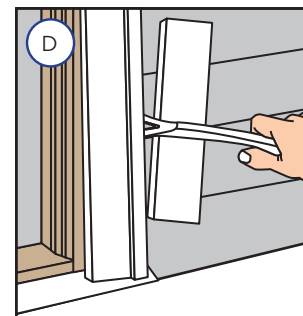
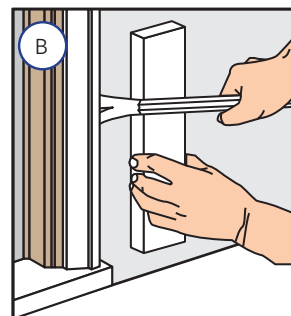
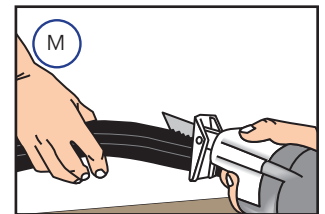
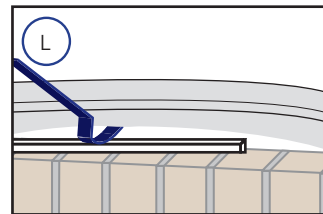

- Remove the door frame.



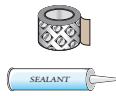

PREPARING FOR SLIDING DOOR INSTALLATION WITH FLUSH FLANGE OR ENDURA CLAD EXTERIOR TRIM FOR REPLACEMENT

YOU WILL NEED TO SUPPLY:











- Moisture resistant shims/spacers (12 to 20) 
- Fasteners (see anchor instructions and tables at the end of this booklet) 
- Closed cell foam backer rod/sealant backer (21 to 30 ft.) 
- Pella® SmartFlash™ foil backed butyl window and door flashing tape or equivalent
- Pella Window and Door Installation Sealant or equivalent high quality, multi-purpose sealant. 
- Low Expansion, low pressure polyurethane insulating window and door foam sealant. DO NOT use high pressure or latex foams 
- Sill pan (optional) 6-5/8" x (Rough Opening Width +2)
- Pella aluminum sill support or wood blocking
- Interior trim and/or jamb extensions (15 to 40 ft.)

Installation Clip Option:

- 6" installation clips (710L) 
- #8 x 1-1/2" corrosion resistant screws or 3/16" x 1-1/2" masonry screws

Clip 710L

TOOLS REQUIRED:

- Tape measure 
- Level 
- Square 
- Hammer 
- Stapler 
- Sealant Gun 
- Scissors or utility knife 
- Tin Snips 
- Screwdrivers (#2 Phillips with 8" shaft and small flat blade) 
- Drill 
- Drill Bits 13/64", 5/32", 1/8" and masonry bit for concrete applications 

WARNING Installation will require (2) or more persons for safety reasons.

Store doors in upright position, out of direct sunlight.

ROUGH OPENING VERIFICATION

A. Confirm the opening is plumb and level.

Note: It is critical the bottom is level and it does not slope to the interior or exterior.

B. Remove dirt, oil or debris from the opening and surrounding wall surfaces.

C. Confirm the door will fit the opening. Measure all four sides of the opening to make sure it is 1/2" to 3/4" larger than the door in both width and 1/2" larger in height. Measure the width and height in several places to ensure the header or studs are not bowed.

Note: 1-1/2" or more of solid wood blocking is required around the perimeter of the opening. Fix any problems with the rough opening before proceeding.

PREPARE THE DOOR FOR INSTALLATION

A. Remove plastic wrap and cardboard packaging from the door. On laminate units, remove protective film from parts. DO NOT open the door until it is securely fastened. DO NOT cut the strap that goes from the lock holes to the sill of the door (if applicable).

B. Inspect the product for any damage such as cracks, dents or scratches. DO NOT install damaged products.

C. For Knock-Down (KD) Doors: Complete field assembly of the frame in accordance with the KD assembly instructions.

D. All Doors: Remove the vent panel prior to installation (if applicable). Slide the vent panel about halfway open. Lift the panel up and tilt the bottom of the panel away from the door frame. Then lower the panel out of the top track. Carefully set the panel aside.

Pella® Reserve and Lifestyle Series Sliding Doors: Remove the shipping spacers off the top and bottom of the vent panel.

Pella® Impervia: Remove the shipping spacers from the bottom of the vent panel.

Pella® 150 Series and Encompass by Pella®: If reversing the door slide direction, refer to the instructions later in this booklet.

E. Units with EnduraClad Exterior Trim without fins or pre-punched holes: Install clips or pre-drill holes for frame screws. Refer to the anchor pages at the end of this booklet.

F. Units with Flush Flange: Apply Flush Flange accessory kit (if applicable) or inspect the flanges or flange to frame seal for damage. Repair or replace damage as necessary.

Additional preparation may be required for Performance Upgrade, impact-resistant products, or to comply with local building code requirements.

G. Read the entire instruction before proceeding.

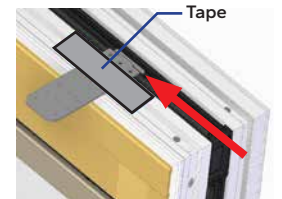
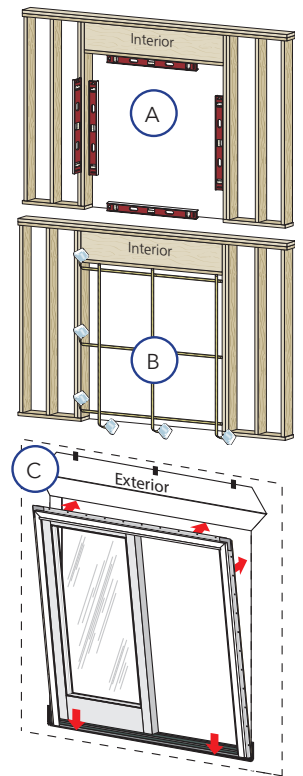

These instructions were developed and tested for use with wall systems designed to manage water. These instructions are not to be used with any other construction methods or door frame types. Installation instructions for use with other construction methods or frame types may be obtained from Pella® Corporation, your local Pella retailer or www.installpella.com. Building designs, construction methods, building materials, and site conditions unique to your project may require an installation method different from these instructions and/or additional care. Determining the appropriate installation method is the responsibility of you, your architect, or construction professional.



BY PURCHASING, INSTALLING OR USING PELLA PRODUCTS (INCLUDES PELLA GOODS AND PELLA SERVICES), YOU AGREED TO THE TERMS OF THE LIMITED WARRANTY AND YOU AND PELLA FURTHER AGREE TO ARBITRATE DISPUTES ARISING OUT OF OR RELATING TO PELLA PRODUCTS, AND YOU WAIVE ANY RIGHT TO PARTICIPATE IN A CLASS ACTION RELATED TO PELLA PRODUCTS unless you notify Pella of your decision to opt out of the Arbitration Agreement no later than ninety (90) calendar days from the date you purchased or otherwise took ownership of Your Pella Goods. Opting out of the Arbitration Agreement will not affect the coverage provided by any applicable limited warranty pertaining to Your Pella Products. For opt out information and additional details please read the Limited Warranty and Arbitration Agreement for your Pella Products at www.Pella.com/arbitration.



FULL FRAME REPLACEMENT WITH ENDURACLAD BRICKMOULD

FULL FRAME REPLACEMENT OF WOOD BRICKMOULD DOORS WITH NEW PELLA® ENDURACLAD® EXTERIOR TRIM

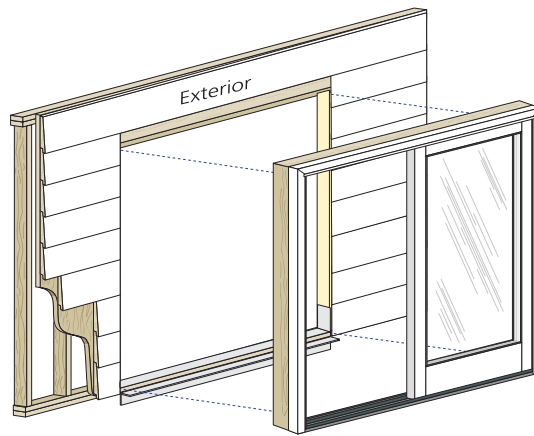
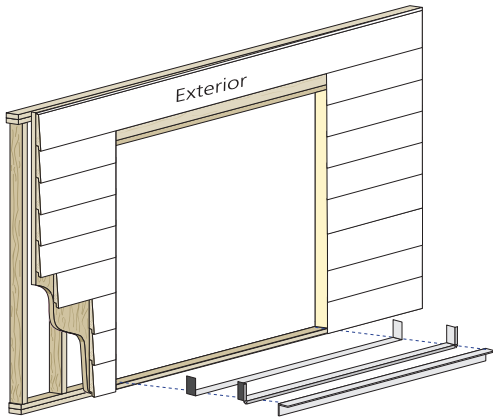

1 PREPARE THE OPENING

Refer to the brickmould frame removal instructions at the beginning of this booklet.

- A. **Measure the width and height of the brick/siding opening and the rough opening.** The new brickmould must be 1/2" to 3/4" smaller than the brick/siding opening. The new window frame must be 1/2" to 3/4" smaller than the rough opening in width and at least 3/8" smaller in height.
- B. **Repair the wall surface around the opening** (if necessary) by installing new blocking flush with the surface of the existing sheathing. Repair the existing building wrap with by cutting it flush with the rough opening and covering any gaps with flashing tape.

Applications with Building Wrap

- C. **Install head flashing** by applying sealant to the back of the upturned leg and inserting the upturned leg behind the building wrap as shown.

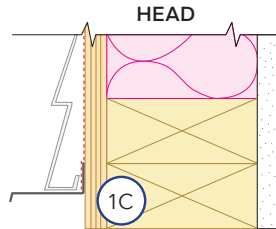

Applications without Building Wrap (steps D and E).

- D. **Cut a piece of flashing tape** equal to the width of the rough opening.
- E. **Apply the tape across the top of the rough opening** so it extends onto the surface of the wall at least 1". Place the tape below any existing head flashing.
- F. **Cut 2 pieces of flashing tape** 12" longer than opening width.
- G. **Apply sill flashing tape #1** at the sill extending 1" to the exterior and 6" up each jamb.
- H. **Cut 1" wide tabs at each corner** by tearing the foil 1/2" each way from corner.
- I. **Apply sill flashing tape #2** overlapping tape #1 by 1" minimum.

Note: Press all tape down firmly.

- J. **Attach a Pella aluminum sill support** or wood blocking flush with the opening sill to support the exterior edge of the door frame if existing materials will not provide support. Skip this step for doors with sill nailing fins.

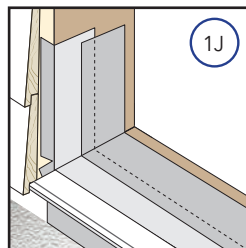
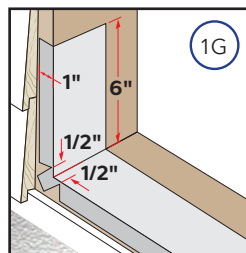
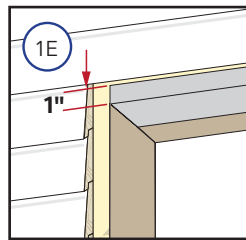
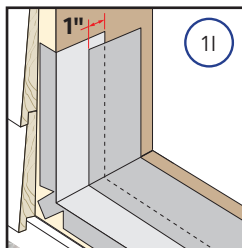

2 SET AND FASTEN THE DOOR

- A. **Place three 3/8" beads of sealant across the opening sill.** Place the interior-most bead 1/2" from where the interior of the door sill will remain after installation. Continue this bead up the sill pan lip, if applicable. **Place a second bead** beginning from the interior bead 1/2" from each side, out to the exterior of the framing and along the opening. Leave 2" voids 4" from the corner and at the center. **Place a third bead** where the exterior of the door sill will remain after installation.

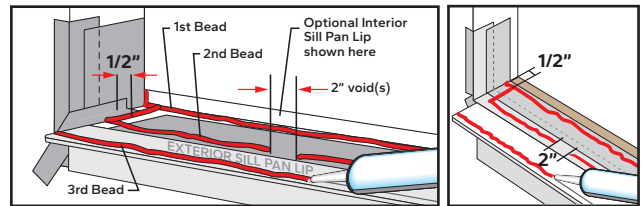

- B. **Place a continuous 3/8" bead of sealant** on the weather barrier (or sheathing if weather barrier is not present) along the jambs and head, approximately 1/2" from the rough opening edge.

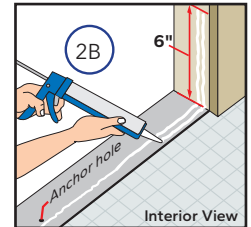

- C. **Insert the door from the exterior of the building** DO NOT slide the bottom of the door into the opening. Sliding will damage the sealant lines. Place the bottom of the door at the bottom of the opening with the door centered between the sides of the opening to allow for shimming, then tilt the top into position.

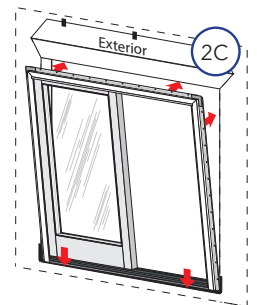

- D. **Check the door placement** by measuring from the interior surface of the door frame or jamb extension to the interior surface of the hole for consistency.
- E. **Pre-drill and drive two screws one near the top of each side** of the door through the frame or clip. (See anchor instructions at the end of this booklet for screw or clip spacing.)



FULL FRAME REPLACEMENT WITH ENDURACLAD BRICKMOULD

FULL FRAME REPLACEMENT OF WOOD BRICKMOULD DOORS WITH NEW PELLA® ENDURACLAD® EXTERIOR TRIM



2 SET AND FASTEN THE DOOR CONTINUED

- F. **Plumb and square the door.** Place shims at each anchor location, lock strike, and head hardware. Keep shims 1/2" short of door frame depth. Insert additional shims starting 6" from the bottom as needed to keep jambs straight and panel reveals even on all four sides.

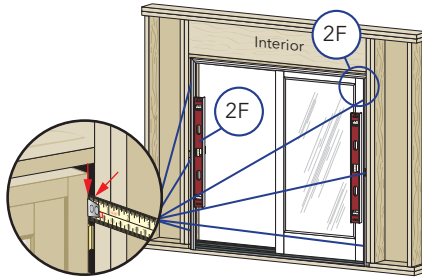

NOTICE Additional shims are required at screw locations for Performance Upgrade, Impact-resistant units, and combinations. See the anchor instructions at the end of this booklet.

Note: For Knock Down doors, install fixed panel. Refer to provided KD assembly instructions.

- G. **Finish anchoring door.** Add screws through lock strikes and hardware (if applicable). Add additional screws through the frame and anchor installation clips as required. Shim at each location that a screw is driven through the frame. (Refer to the anchor instructions at the end of this booklet.)
- H. **Install the sliding panel.** From the exterior, tilt the top of the panel and insert it into the top track. Move the bottom of the panel toward the door frame and set it on the bottom track. Be careful not to pinch your fingers between the two panels. DO NOT close the sliding panel until the hardware is installed. The door may lock when closed.
- I. **Check door operation.**

Note: Adjust shims to correct any issues with plumb, square, operation or reveal.

- J. **Install panel retainers (if applicable) or re-install if the vent panel was removed during installation** Refer to the instructions included in the panel retainer hardware package.

WARNING Panel Retainer **MUST** be installed to reduce risk of serious injury or death from a falling door panel. If panel retainer is lost or damaged, **DO NOT INSTALL DOOR.** Contact your Local Pella Retailer or Pella Customer Service (877) 473-5527 for replacement.

Install bumpers (if applicable). Refer to the anchor instructions at the end of this booklet.

- K. **Install the handles.** Refer to the instruction in the hardware box.

2 SET AND FASTEN THE DOOR CONTINUED

- L. **Adjust the panel height to 1/4" clearance from bottom of panel to sill track** by removing the hole cover (if applicable) and using a #2 Phillips screwdriver to turn the roller adjustment screw clockwise (raise) or counterclockwise (lower).

Note: Reinstall the hole cover (if applicable) once adjustments are complete.

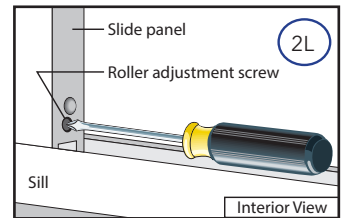

NOTICE Check vent panel to frame and vent panel to fixed panel reveal.

NOTICE For doors with heavy impact-resistant or triple-pane glass use a small pry bar to raise the panel while turning the adjustment screw. This will prevent the threads from being stripped (applies to all methods).

- M. **Pella Reserve and Lifestyle Series:** Adjust the Vent Lock Tip (if applicable). Refer to the anchor instructions at the end of this booklet.
- N. **Encompass by Pella® and Pella® 150 Series doors:** Install the keeper and adjust the lock hook (if necessary). Refer to the anchor instructions at the end of this booklet.
- O. **Check door operation** by opening and closing the door.

3 APPLY SEALANTS

- A. **Install interior sealant.** Refer to the interior sealant instructions at the end of this booklet. Use additional sealant around clips to prevent air and water infiltration (if applicable).
- B. **Install exterior sealant between the edge of the brickmould and the finished wall material or flashing.** Refer to the exterior sealant instructions at the end of this booklet.



ANCHOR INSTRUCTIONS - FLUSH FLANGE AND ENDURA CLAD® EXTERIOR TRIM

INSTALLATION METHODS FOR PELLA® RESERVE AND PELLA® LIFESTYLE SERIES SLIDING PATIO DOORS

Note: Standard performance only. Additional anchoring may be required for Performance Upgrade or to comply with local building code requirements.

Location	Anchor Type		Instructions	Drawing	
	Wood	Masonry			
Head	Vent Lock Strike	#10 x 2-1/2" (provided)	Pilot drill using 5/32" bit and drive (1) screw through Vent Lock Strike.	B	
	Fixed Panel Bracket		Pilot drill using 5/32" bit and drive (1) screw through Fixed Panel Bracket.	C	
	Frame Screws	#10 x 2-1/2" PH	Pilot drill using 5/32" bit and drive screws 6" from corner.	C.1	
	Interlocker Frame Screws*		OX or XO and Performance Upgrade or over 95.25" x 95.5" only: Add screws 5" on either side of Vent Lock Strike and Fixed Panel Bracket screws.		
	Installation Clips		(2) #6 x 1-1/4"		Slide clip into slot from end and adhere to frame with tape 6" from corner.
Jamb	Lock Strike (OX or XO)	#8 x 3" (provided)	3/16" x 3"	Complete per each strike. Pilot drill using 1/8" bit and install (2) installation screws diagonally. Install cover after screws.	E
	Lock Strike (OXO or OXXO)	#8 x 2-1/2" (provided)	N/A	Install (2) short screws diagonally. Install cover after screws.	E.1
	Frame Screws	#10 x 2-1/2" PH	1/4" x 2-1/2"	Pilot drill using 5/32" bit and drive screws 6" from corner and 20" on center.	C
	Installation Clips	(2) #6 x 1-1/4"	3/16" x 1-1/2"	Slide clip into slot from end and adhere to frame with tape 6" from corner and 20" on center.	D
Sill	Frame Screws*	#8 x 3" FH or #10 x 2-1/2" FH	1/4" x 2-1/2"	Performance Upgrade or over 95.25" x 95.5" only: Use factory pre-drilled holes (if applicable). Pilot drill with 1/8" bit and apply sealant before driving screws. Not required if Standard Performance OX or XO and 95.25" x 95.5" or under.	F

Use corrosion resistant fasteners compatible with construction materials. Shim as required at anchor locations.

For light gauge steel framing, use #10 self-tapping screws with minimum 3 thread embedment.

*Additional anchors required for Performance Upgrade or frame sizes exceeding 95.25" x 95.5".

Units with Pella EnduraClad exterior trim without fins or pre-punched holes must be anchored with frame screws or installation clips.

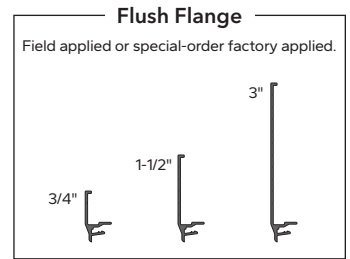
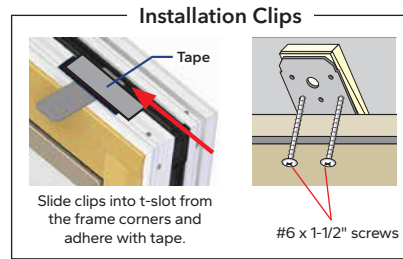
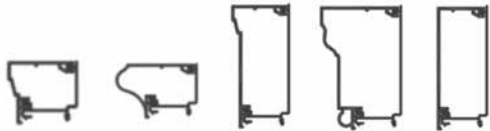

Elevation View

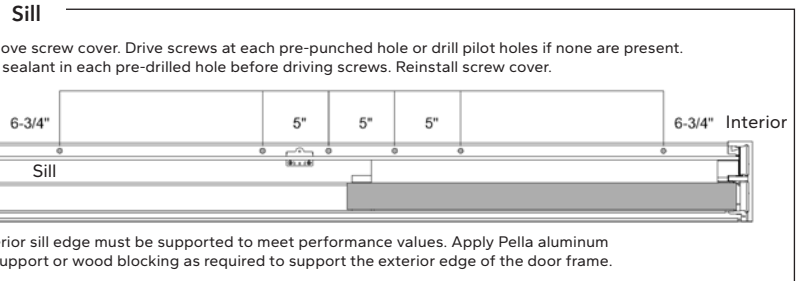
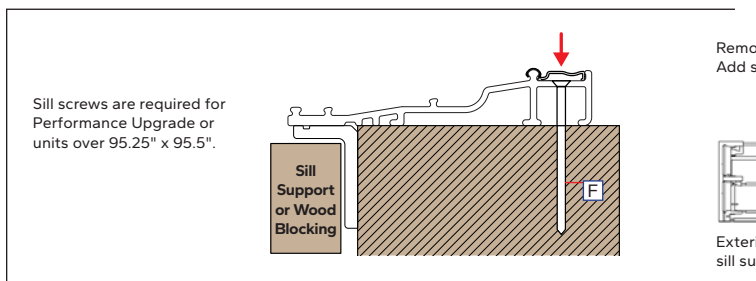
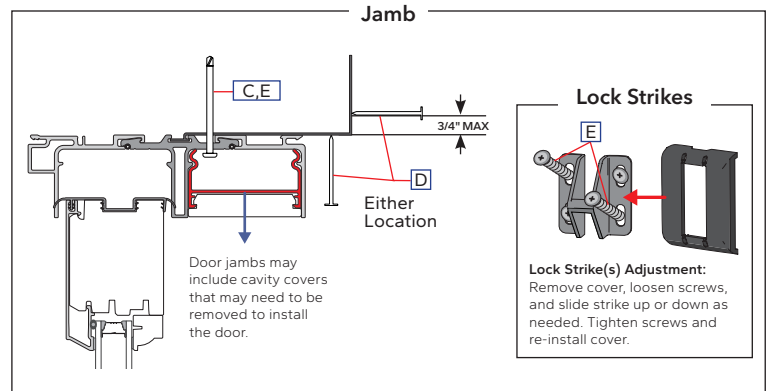
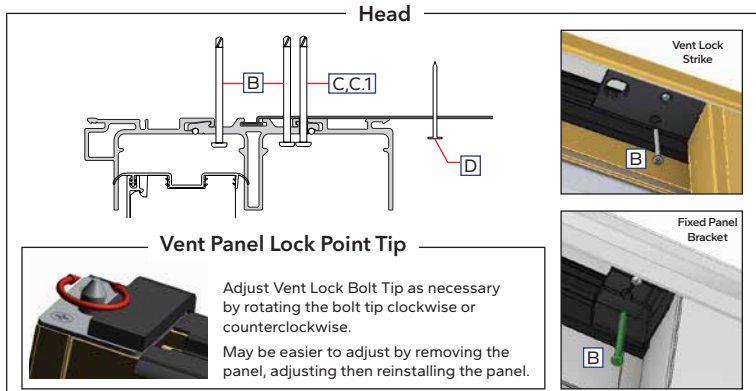
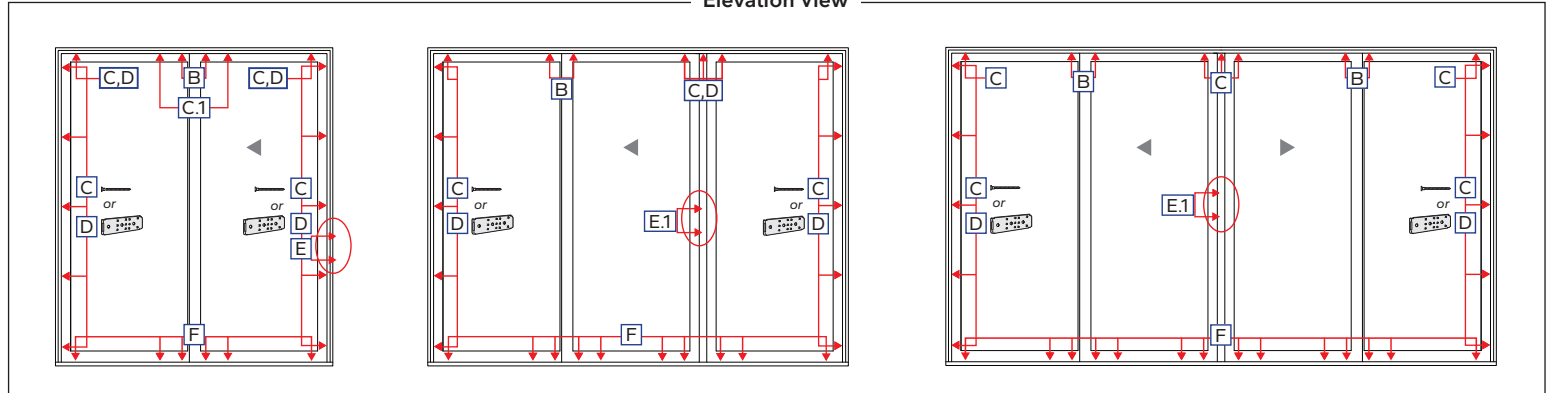



INTERIOR AND EXTERIOR SEALANT

Interior Sealant Instructions



CAUTION Continuous backer rod (as necessary) and a high quality, low-odor interior sealant such as Pella Window and Door Installation Sealant (or equivalent) is recommended for commercial or high performance installations to create the continuous interior seal. Follow the directions on the cartridge. For standard performance or products with factory applied jamb extensions, use low pressure polyurethane insulating foams. Follow the directions on the can. Do not use high pressure or latex foams. Fiberglass batt or similar insulation is not recommended as it can absorb water and does not act as an air seal.

- A. **Insert the nozzle or straw** between the rough opening and door frame from the interior. Use a pliers (if necessary) to compress the end of a straw tube to allow it to fit in tight openings.
- B. **Place a 1" deep bead of foam approximately 1" from the interior of the frame** to allow for expansion. DO NOT fill the entire depth of the rough opening cavity.

Note: Apply foam between the frame and rough opening, NOT between jamb extensions and the rough opening.

- C. **Re-Check door operation** and remove remaining shipping spacers after foam installation. Excess foam may be removed with a serrated knife after it cures.
- D. **To ensure a continuous interior seal**, apply sealant over or around any shims or clips interrupting the foam seal.
- E. **Place a continuous bead of sealant across the inner sill at the intersection of the door sill and subfloor.** Continue the sealant 6" up each jamb.

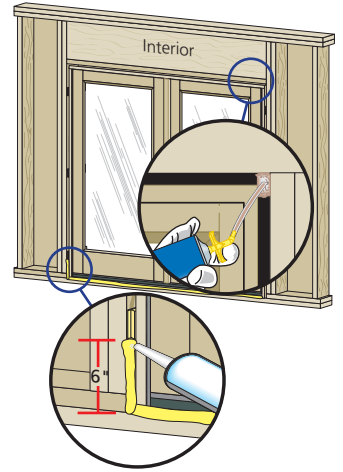

Exterior Sealant Instructions



CAUTION Use a high quality, multi-purpose exterior sealant such as Pella Door and Door Installation Sealant. Follow the directions on the cartridge.

Flush Flange Doors:

- A. **Place a corner bead of sealant** on the edge of the flush flange on the top and sides.

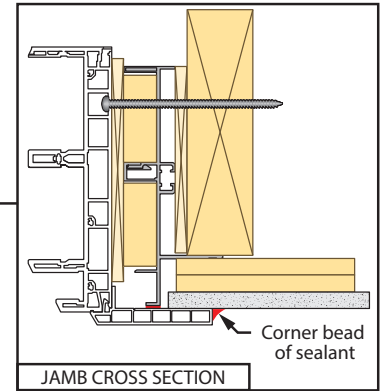
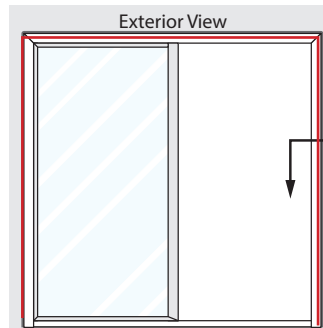

Flush Flange Doors

- B. **For a door without the flush flange at the sill**, install a corner cap at the bottom of each jamb flush flange. Remove the release paper from the adhesive strips on the back of the corner cap, and press the corner cap onto the bottom of the jamb flush flange.

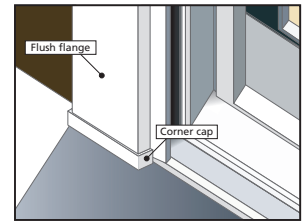
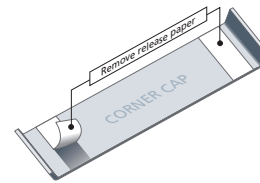

Enduraclad Exterior Trim Doors:

- A. **Insert backer rod 3/8" deep** in the space around the door. Backer rod adds shape and controls the depth of the sealant line.
- B. **Apply a continuous bead of sealant to the entire perimeter of the door.**
- C. **Shape, tool and clean excess sealant.** When finished, the sealant should be the shape of an hourglass.

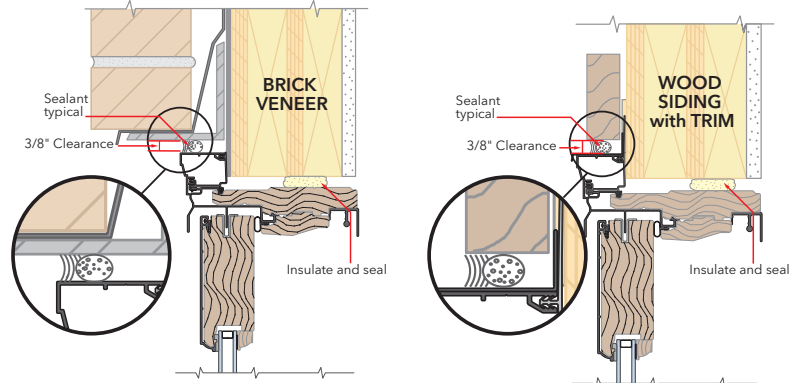



OPTIONAL SILL PAN INSTRUCTIONS

A. Cut the sill pan to the width of the rough opening plus 2".

NOTE: The 2" added onto the rough opening width is for a 1" bend on each end.

B. Make a 1" cut in each fold at both end of the sill pan.

NOTE: These cuts will allow the edges of the sill pan to be bent.

C. Cut 1" off each end of the interior sill pan lip.

D. Bend each end of the center panel up.

E. Install the sill pan by sliding into place until the exterior sill pan lip is flush with the exterior of the rough opening.

F. Apply sill flashing tape. Cut a piece of flashing tape 2" longer than the opening width. Apply at the bottom of the opening, covering the exterior sill pan lip as shown.

NOTE: If applicable, apply spray adhesive to building felt prior to applying the flashing tape.

G. Cut a piece of flashing tape to the width of the opening. Install tape to the sill pan and overlap the flashing tape from step 1F by 1". If needed add a second or third piece of flashing tape until the sill pan is covered to the interior sill pan lip.

NOTE: The purpose of this tape is to seal the sill screws when installing the door.

H. Cut two 9" pieces of flashing tape with a 1" x 3" tab at the bottom, on opposite corners as shown.

I. Apply the tabbed 9" pieces of flashing tape. The tape is applied so 2" will cover the inside of the rough opening and lap over the side flange of the sill pan. The 1" x 3" tab laps over the bottom flashing tape as shown.

J. Cut two 6" pieces of flashing tape and apply to each side of the rough opening, overlapping the first piece by 1" and lapping the bottom over the side flange of the sill pan as shown.

K. Cut two pieces of flashing tape 1-1/2" x 6" and apply to the bottom corners of the opening by beginning in the corner of the sill pan, with 3/4" of the tape applied to the sill pan and 3/4" of the tape applied to the side flange. The remainder of the tape is to be at a 45 degree angle onto the exterior.

L. Attach the aluminum sill support or wood blocking to the exterior of the box plate to support the edge of the door sill. Place the sill support flush with the subfloor.

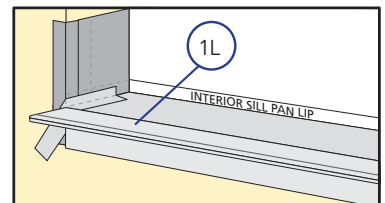
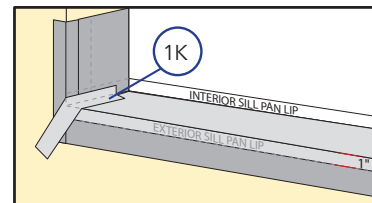
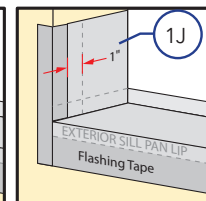
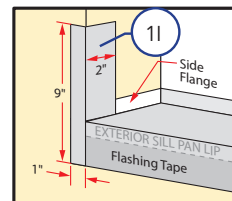
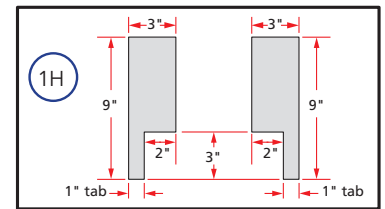
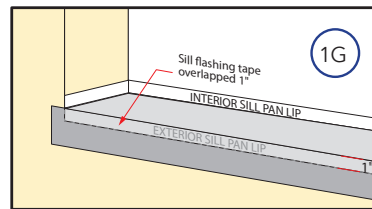
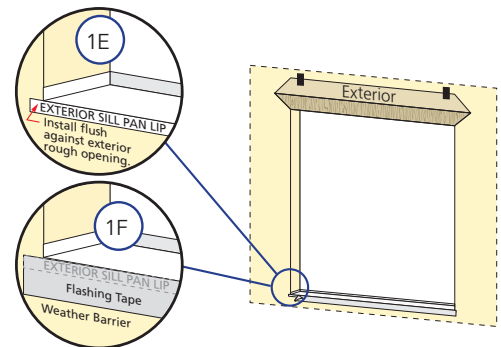
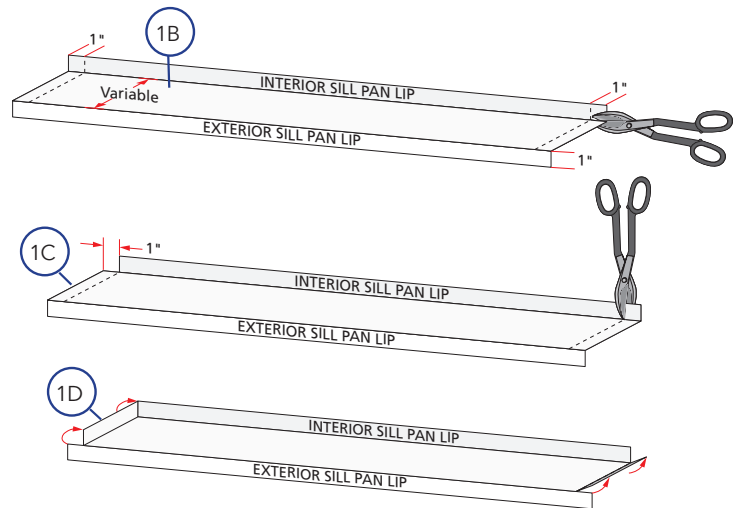

Concrete Slab (without sill pan) Instructions

NOTE: Thoroughly clean the slab where sealants will be installed. Instead of installing flashing tape across the bottom of the rough opening, complete the following:

- Install flashing tape at the bottom 6" of the rough opening jambs.
- Cut (2) 9" pieces of flashing tape as shown in step 1H above.
- Install them overlapping the flashing tape installed in step A by 1".
- Place a 3/8" bead of sealant where the bottom edge of the flashing tape meet the concrete slab.
- When folding building wrap in at the jambs, cut at a 30 degree angle as illustrated.

Follow the applicable installation method pages to complete the installation except seal the door sill directly to the slab.

