

VINYL WINDOWS AND DOORS

Manufactured by Pella Corporation

VINYL 1" STRUCTURAL TUBE MULLION ASSEMBLY INSTRUCTIONS











Be sure to thoroughly read and understand all the steps before beginning the mullion assembly process.

YOU WILL NEED TO SUPPLY:

- Foil backed butyl window and door flashing tape or equivalent
- High quality, multi-purpose sealant
- Isopropyl Alcohol
- 1/4" Masonry Screws or #10 Wood Screws
- #10 Self-Tapping Pan Head Screws



TOOLS REQUIRED:

- Tape measure 
- Hammer 
- Sealant gun 
- Drill with 3/16" & 1/4" & 1/4" Counter-Sink drill bits 
- 1/4" wide chisel 
- Utility knife 
- Tin Snips 
- Straight edge Level 
- Marker (fine point) or pencil 
- Combination square 
- Rubber mallet 

REMEMBER TO USE APPROPRIATE PERSONAL PROTECTIVE EQUIPMENT.

AT LEAST TWO PEOPLE ARE REQUIRED TO SAFELY PERFORM THIS PROCEDURE.

FIELD MULLION RULES:

1. DO NOT use more than three 1" mullions in one combination.
2. Horizontal and Vertical 1" mullions are not permitted in the same combination.
3. Mullered product combination cannot exceed 96 ft² for 1" mullion system.
4. The length of any mullion may not exceed 108" for 1" mullion system.
5. Any window greater than 25 ft² may not be mullered horizontally above a fixed 1-wide product.
6. 1" mullion requires 90° frame angle adjacent to mullion ends.
7. 1" structural mullion allowed on block frame and 5/8" flange frames only.

FIXED UNDER MULLION RULES:

These rules apply AFTER all standard mullion rules are applied:

1. Any window < 20 ft² may be mullered horizontally above a fixed 1-wide product.
2. Any window < 40 ft² may be mullered horizontally above a fixed 2 or 3-wide product.
3. Max bottom unit FW must be < 48" for 1-wide bottom fixed, and < 96" for 2 or 3-wide bottom units.

1 PREPARE THE WINDOWS:

- A. **Prepare the rough opening** in accordance with the product installation instructions. Flashing materials, weather resistive barriers and sill pans (if used) must be installed prior to installing the tube mullion.
- B. **Measure and mark the locations for the tube mullion(s).**

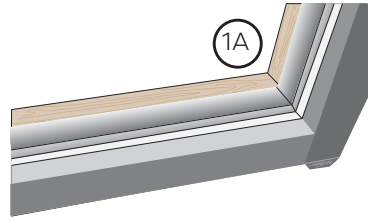

Example: For a 2-wide combination with equal width windows or doors; measure the width of the rough opening and mark the center of the opening. Confirm each window unit will fit between the 1" wide tube mullion and the edge of the rough opening with approximately 1/4" minimum of clearance on each side.

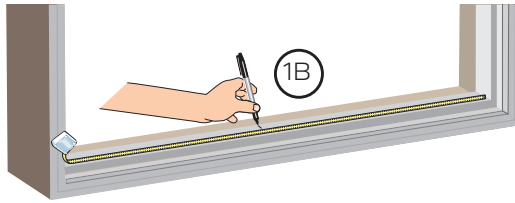

2 TUBE MULLION ASSEMBLY AND INSTALLATION:

Check local building code installation and anchoring requirements prior to mullion preparations.

- A. **Cut tube mullion to Length, if necessary.** Length = Opening width or height - 1/2".
- B. **Pre-Drill end anchor holes, two on each side based on appropriate configuration.** Use 1/4" drill bit to drill the holes in the end anchors for masonry applications and 3/16" drill bit to drill holes for wood applications based on the installation configuration end anchor needs, (Standard or offset end anchor). Counter-sink holes as necessary.

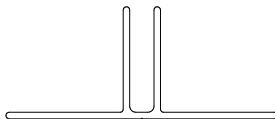
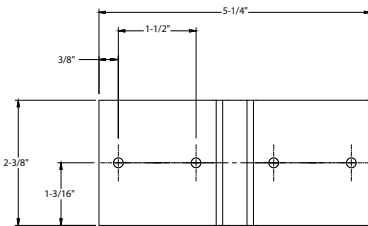

Standard End Anchor Configuration

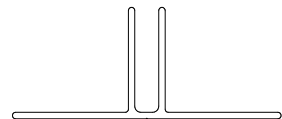
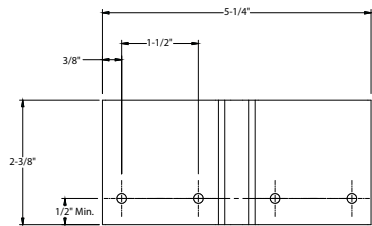

Optional Offset End Anchor Configuration

2 TUBE MULLION ASSEMBLY AND INSTALLATION (CONTINUED):

- C. Insert tube mullion end anchors into each end of the tube mullion(s).

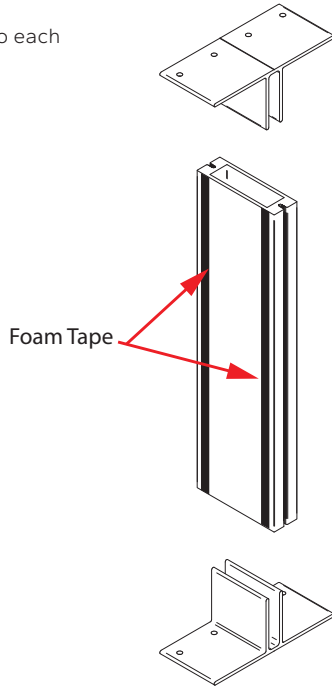

- D. Place the tube mullion(s) in the opening.

Windows and doors with frontal flanges or block/box frames: Align the exterior surface of the tube mullion where the exterior surface of the window will be located.

Place the center of the tube in line with the marks from step 1B.

Check the tube mullion for plumb and square in both directions.



2 TUBE MULLION ASSEMBLY AND INSTALLATION (CONTINUED):

- E. **Install anchor screws.** Install two (2) screws on each side of the end anchor (4 per anchor).

For anchoring into concrete use 1/4" masonry screws with sufficient length to achieve a 1-3/4" minimum embedment with 2" minimum edge distance. Locate anchors as shown.

For anchoring into wood framing use #10 wood screw with sufficient length to achieve a 1-3/8" minimum embedment. Locate anchors as shown.

- F. **Attach end anchors to tube mullion using #10 x 1/2" TEK Self drilling screws** (included in mull kit). Offset the screws to eliminate interference.

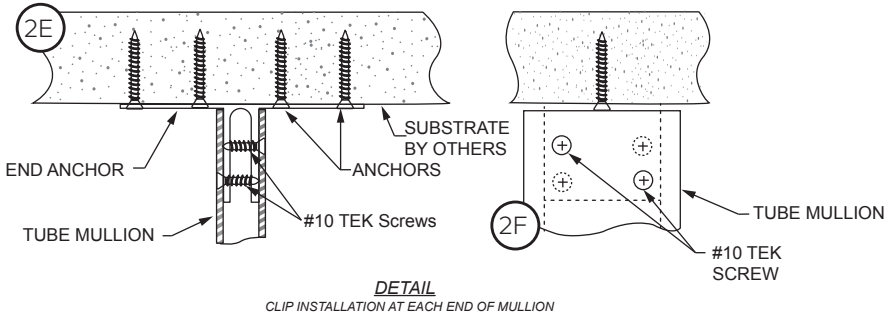

- G. **Seal around each end of tube mullion(s).**

Vertical Mulls: Seal completely around each end of the tube mullion(s). At the lower end of the vertical mull, seal the end anchor by placing sealant around the perimeter of the end anchor.

Horizontal mulls: Seal the interior and exterior surfaces of the tube mull ends, leaving a 1-1/2" gap along the top and bottom surfaces toward the exterior.

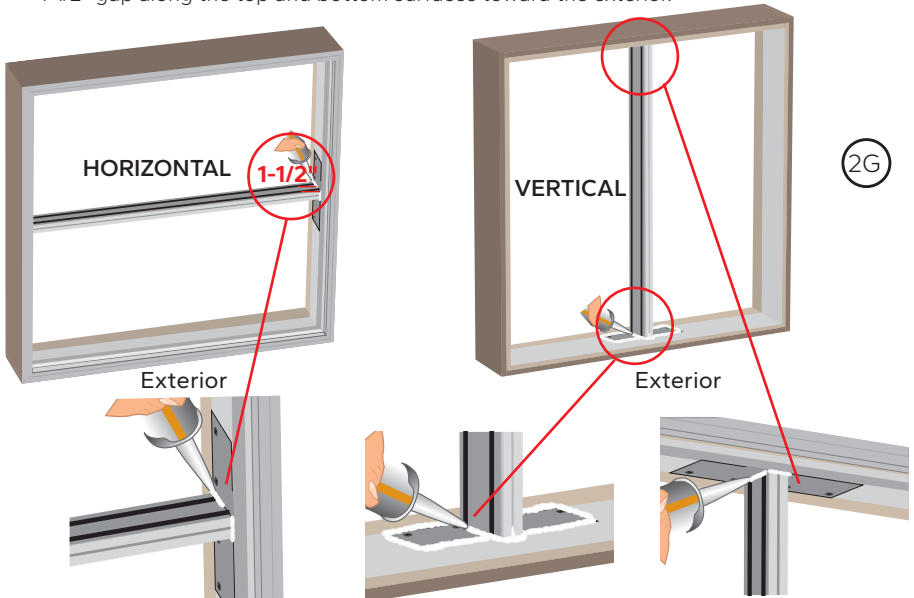

3 WINDOW INSTALLATION:

- A. **Install windows according to their installation instructions.** If using windows with frontal/flush flanges, DO NOT cover exterior groove of the tube mullion with flanges. Trim flanges if necessary.
- B. **Windows need to be tilted** into opening to ensure contact with foam sealing tape on the tube mullion. DO NOT slide window in; place window frame against foam tape first, then tilt opposite side of frame into position.
- C. **Attach windows to the tube mullion using #10 self-tapping pan head screws** (not provided). Use screw of appropriate length for the type of window frame being installed. Pre-drill through the window frame for anchoring screws. Refer to the window anchoring instructions for screw and shim spacing and locations. Finish securing the window in the opening.

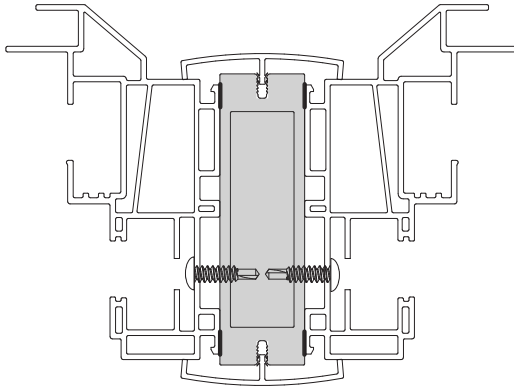

HORIZONTAL MULLION COVERS ONLY:

- D. **Drill a 3/16" diameter weep hole on each end of horizontal mullion cover(s).** Locate weep holes 3" from each end and 5/8"-3/4" from the top of the cover.

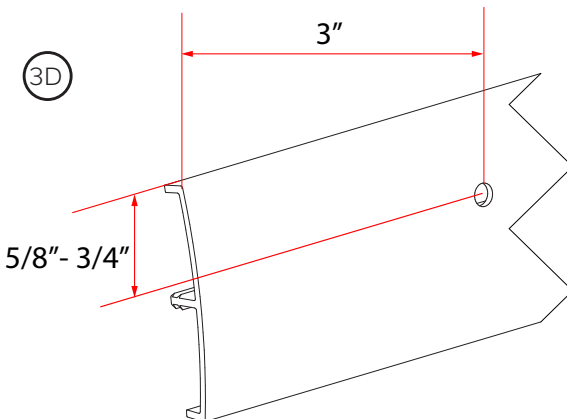

3 WINDOW INSTALLATION (CONTINUED):

- E. **On each end, place a 6" bead of sealant in the groove** in the exterior of the tube mullion. Tie sealant in with perimeter sealant application. Install exterior mullion cover (cut to length if necessary). Starting at one end, use a rubber mallet to drive the cover into the groove.

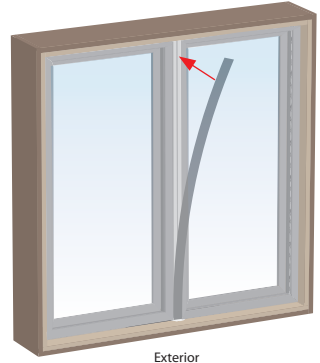
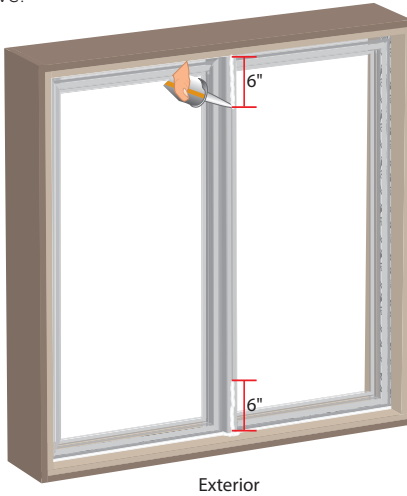

Exterior

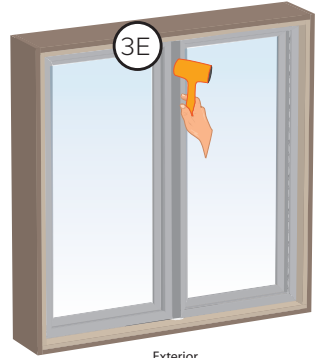

Exterior

NOTE: Make sure weep holes in horizontal mullion covers are not blocked by sealant.

- F. **Place sealant at both ends** of the horizontal covers and at the top end of vertical covers, making sure to connect the sealant with the exterior perimeter sealant. **DO NOT** seal the bottom end of vertical covers.

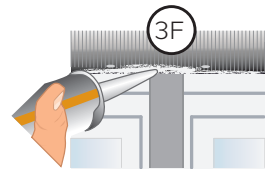

- G. **Install interior mullion cover** (cut to length if necessary). Starting at one end, use a rubber mallet to drive the cover into the groove.

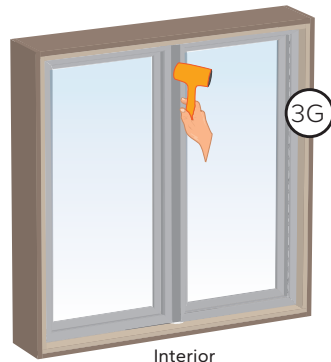

Interior