



IMPORTANT SAFETY AND PRODUCT INFORMATION – DOORS

Safety Alert Symbol Reference: These symbols are intended to alert you to potential injury hazards and information. Obey all safety messages.

COULD
Result in:



COULD
Result in:



COULD
Result in:



COULD
Result in:



WARNING To ensure safety and security and help prevent property damage, including possible damage to your window or door, close and lock windows and doors any time they are not being used for venting on a nice day, and particularly during high winds or rain. Ensure all windows and doors are properly fastened to the wall structure according to the product anchor instructions. It is the responsibility of the Buyer or User, the architect, contractor, installer, or other construction professional to ensure the appropriate windows and doors are chosen for the project and the wall construction is designed to resist all loads in accordance with local building code requirements.



CAUTION Many doors in older homes are painted with lead-based paint. Removal of old doors may disturb this paint. Proper precautions must be taken to minimize exposure to dust and debris. Consult state or local authorities and/or go to www.epa.gov/lead for more information.



NOTICE Pella products must be stored in an upright, level position not exposed to weather. The storage must be ventilated and provide protection from direct sunlight and excessive temperature.



IMPORTANT NOTICE Because all construction must anticipate some water infiltration, it is important that the wall system be designed and constructed to properly manage moisture. Pella Corporation is not responsible for claims or damages caused by anticipated and unanticipated water infiltration; deficiencies in building design, construction and maintenance; failure to install Pella products in accordance with Pella's installation instructions; or the use of Pella products in wall systems which do not allow for proper management of moisture within the wall systems. The determination of the suitability of all building components, including the use of Pella products, as well as the design and installation of flashing and sealing systems are the responsibility of the Buyer or User, the architect, contractor, installer, or other construction professional and are not the responsibility of Pella.

Pella products should not be used in barrier wall systems which do not allow for proper management of moisture within the wall systems, such as barrier Exterior Insulation and Finish Systems (EIFS) (also known as synthetic stucco) or other non-water managed systems. Except in the states of California, New Mexico, Arizona, Nevada, Utah and Colorado, Pella makes no warranty of any kind on and assumes no responsibility for Pella windows and doors installed in barrier wall systems. In the states listed above, the installation of Pella Products in barrier wall or similar systems must be in accordance with Pella's installation instructions. Product modifications that are not approved by Pella Corporation will void the warranty.

CARE AND MAINTENANCE: Refer to the Pella Owner's Manual. Visit www.pella.com or your local seller for more information.

CLEANING INSTRUCTIONS: Refer to the Pella Owner's Manual for comprehensive maintenance and cleaning information. Visit www.pella.com or your local seller for more information.



NOTICE DO NOT apply any other types of film to the glass. Doing so could void product warranty.



NOTICE DO NOT use abrasives. DO NOT scrape or use tools that might damage the surface.



NOTICE DO NOT use inappropriate solvents or brickwash or cleaning chemicals. If you do, permanent damage can result and the product failure, loss or damage would not be covered by the Limited Warranty.

FINISHING INSTRUCTIONS (WOOD PATIO DOORS): Paint or finish immediately after installation.

If products cannot be finished immediately, cover with clear plastic to protect from dirt, damage and moisture. Remove any construction residue before finishing. Sand all wood surfaces lightly with 180 grit or finer sandpaper. DO NOT use steel wool. BE CAREFUL NOT TO SCRATCH THE GLASS. Remove sanding dust. Pella products must be finished according to these instructions; failure to follow these instructions voids the Limited Warranty. Finishing panel edges is optional for Patio Doors.



NOTICE To maintain proper product performance do not paint, finish or remove the weatherstripping, mohair dust pads, gaskets or vinyl parts. Air and water leakage will result if these parts are removed. After finishing, allow venting Doors and doors to dry completely before closing them. If paint, stain or finish gets on the weatherstripping, wipe it off immediately with a damp cloth.

PANEL CLEANING AND PREP INSTRUCTIONS FOR UNFINISHED OR PRIMED PANELS: Dry wipe dust from doors gently. Examine door for possible smudges or fingerprints made from normal handling or construction. To remove smudges, lightly wipe surface with warm water. Let door and sidelight surfaces dry completely before applying finish. Finish the door panels as soon as possible after installation.

UNFINISHED INTERIOR FRAME MEMBERS: Unprimed interior frame parts may be stained with wood stains and should be finished with a minimum of two coats of a clear polyurethane finish.

PAINTING INSTRUCTIONS: Wood door frame exteriors are factory primed. Wood doors require painting immediately after installation. The factory applied primer is not intended for long term exterior exposure. Sand all un-primed interior wood surfaces lightly with 180 grit or finer sandpaper before priming and painting. Use two coats of a 100% latex paint that has a good blocking resistance. Finishing panel edges is optional for Patio Doors.

Pella Corporation is not responsible for interior paint and stain finish imperfections for any product that is not factory-applied by Pella Corporation. For additional information on finishing see the Pella Owner's Manual or go to www.pella.com.







NOTICE The use of unapproved finishes, solvents or cleaning chemicals may cause adverse reactions with door materials. Pella will not be responsible for problems caused by the use of unapproved materials. If in doubt, contact your local retailer or representative.

EXTERIOR FINISH OF EXISTING FRAME (POCKET REPLACEMENT): It is the responsibility of the homeowner, contractor or installer to ensure any exposed unfinished wood is covered or finished. Possible methods include, however are not limited to, covering with aluminum coil stock or painting.



PREPARING FOR BLOCK FRAME SLIDING DOOR INSTALLATION

YOU WILL NEED TO SUPPLY:

- Moisture resistant shims/spacers 
- Fasteners (see block frame anchor instructions and tables at the end of this booklet)
- Closed cell foam backer rod/sealant backer 
- Pella® SmartFlash™ foil backed butyl window and door flashing tape or equivalent 
- Low expansion, low pressure polyurethane insulating window and door foam sealant DO NOT use high pressure or latex foams. 
- Pella Window and Door Installation Sealant or equivalent high quality, multi-purpose sealant 









INSTALLATION CLIP OPTION

(Pella® Reserve, Pella® Lifestyle Series and Pella® Impervia only):

- 6" installation clips (710L)
- #8 x 1-1/2" corrosion resistant screws or 3/16" x 1-1/2" masonry screws



TOOLS REQUIRED:

- Tape measure 
- Level 
- Square 
- Hammer 
- Scissors or utility knife 
- Small flat blade screwdriver 
- Sealant Gun 
- Screw Gun with a Phillips Driver bit
- 1/8" Allen wrench 
- Drill 
- Drill bits 1/8", 5/32", 3/8", and masonry drill bits for masonry applications
- Fine tooth chop saw
- Large hook tool

Other construction materials may be required. Read and understand the instructions and inspect the wall conditions before you begin.

WARNING Installation will require (2) or more persons for safety reasons.

PREPARE THE DOOR FOR INSTALLATION

- Remove plastic wrap** and cardboard packaging from the door. For Pella® 250 Series doors with laminate film, remove protective film from all parts.
- Inspect the product for any damage** such as cracks, dents or scratches. DO NOT install damaged products.
- For Knock-Down (KD) Doors:** Complete field assembly of the frame in accordance with the KD assembly instructions.
- All Doors:** Remove the vent panel prior to installation (if applicable). Slide the vent panel about halfway open. Lift the panel up and tilt the bottom of the panel away from the door frame. Then lower the panel out of the top track. Carefully set the panel aside.

Pella® Reserve and Lifestyle Series Sliding Doors: Remove the shipping spacers off the top and bottom of the vent panel.

Pella® Impervia: Remove the shipping spacers from the bottom of the vent panel.

Pella® 250 Series: Remove the jamb pocket covers/caps and head cover/cap. For laminate units, remove the laminate protective film. Pre-drill anchor holes.

Pella® 150 Series and Encompass by Pella®: If reversing the door slide direction, refer to the instructions later in this booklet.

- Units with EnduraClad Exterior Trim without fin or pre-punched holes:** Install clips or pre-drill holes for frame screws.

Installation clip option (Reserve, Lifestyle Series, and Impervia): Installation clips can often be used in place of frame screws. Slide clips into the t-slot groove at the upper frame corners and secure clips to the frame with tape.

Refer to the anchor pages at the end of this booklet. Additional preparation may be required for Performance Upgrade, impact-resistant products, or to comply with local building code requirements.

- Read the entire instruction before proceeding.**

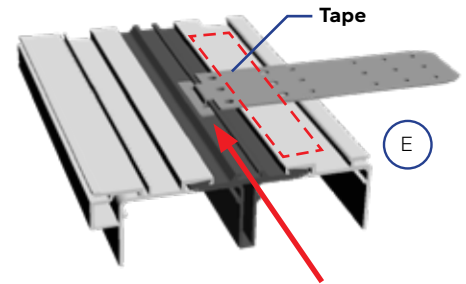
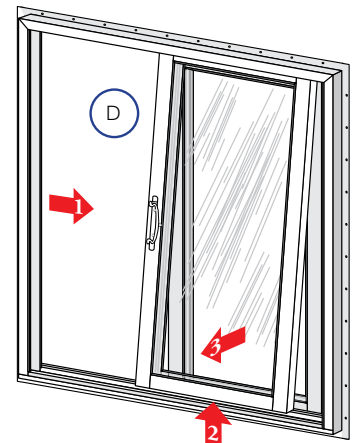

Installation Clip option

These instructions were developed and tested for use with wall systems designed to manage water. **These instructions are not to be used with any other construction methods or doorframe types.** Installation instructions for use with other construction methods or frame types may be obtained from Pella® Corporation, your local Pella retailer or www.installpella.com. Building designs, construction methods, building materials, and site conditions unique to your project may require an installation method different from these instructions and/or additional care. Determining the appropriate installation method is the responsibility of you, your architect, or construction professional.



BY PURCHASING, INSTALLING OR USING PELLA PRODUCTS (INCLUDES PELLA GOODS AND PELLA SERVICES), YOU AGREED TO THE TERMS OF THE LIMITED WARRANTY AND YOU AND PELLA FURTHER AGREE TO ARBITRATE DISPUTES ARISING OUT OF OR RELATING TO PELLA PRODUCTS, AND YOU WAIVE ANY RIGHT TO PARTICIPATE IN A CLASS ACTION RELATED TO PELLA PRODUCTS unless you notify Pella of your decision to opt out of the Arbitration Agreement no later than ninety (90) calendar days from the date you purchased or otherwise took ownership of Your Pella Goods. Opting out of the Arbitration Agreement will not affect the coverage provided by any applicable limited warranty pertaining to Your Pella Products. For opt out information and additional details please read the Limited Warranty and Arbitration Agreement for your Pella Products at www.Pella.com/arbitration.



NEW CONSTRUCTION INSTALLATION IN MASONRY CONSTRUCTION FOR BLOCK FRAME SLIDING DOORS (OR THE INSTALLATION OF NEW BLOCK FRAME DOORS INTO MASONRY OPENINGS)

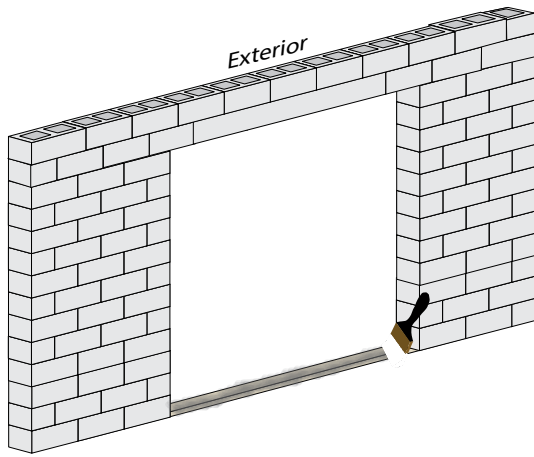

1 PREPARE THE OPENING

REMEMBER TO USE APPROPRIATE PERSONAL PROTECTIVE EQUIPMENT.

A. **Clean the opening.** Ensure it is dry and free from dirt, oil and debris.

If using an optional sill pan, refer to the sill pan instruction page at the end of this booklet.

B. **Apply water resistant coating** to the masonry. Extend the coating into the opening on all four sides. The water resistant coating may be a self-adhered sheet membrane (SASM) or a liquid applied flashing. Ensure continuity between the water resistant coating in the opening and the rest of the wall surface. SASM's must be overlapped in a water shed fashion. Apply all water resistant coatings according to the manufacturer's directions.

NOTICE Allow liquid flashing to dry according to the manufacturer's recommendations.

C. **Measure the width and height of the opening.** The new door must be 1/2" to 3/4" smaller in width and 3/8" to 1/2" small in height than this measurement.

D. **Confirm the opening is plumb, level and square.** Dry fit the door and remove it from the opening.

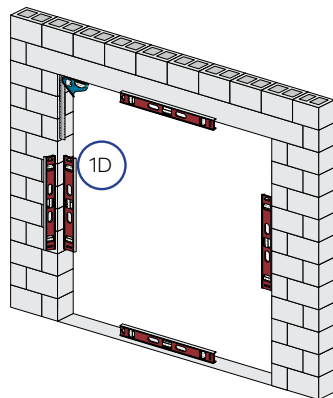
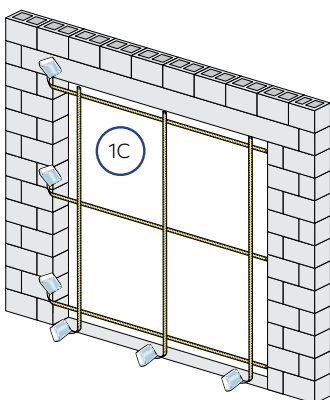
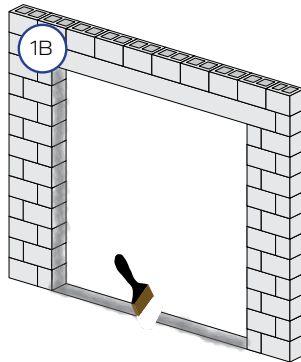

E. **Measure and mark the opening** where the interior of the new door will be placed. Consider the size of wall cavity (if applicable) and 3/4" minimum overlap onto the brick veneer or finished wall materials for exterior perimeter sealant.

2 SET AND FASTEN THE DOOR

A. **Attach a Pella aluminum sill support** or wood blocking flush with the opening sill if a concrete slab will not provide support for the exterior edge of the frame.

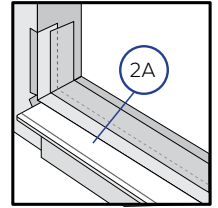

For 150 Series / Encompass doors without sill nail fins, skip to step C.

B. **Place three 3/8" beads of sealant across the opening sill.** Place the interior-most bead 1/2" from where the interior of the door sill will remain after installation. Continue this bead up the sill pan lip, if applicable. **Place a second bead beginning from the interior bead 1/2" from each side,** out to the exterior of the framing and along the opening. Leave 2" voids 4" from the corner and at the center. Place a third bead where the exterior of the door sill will remain after installation.

Proceed to step 2G.

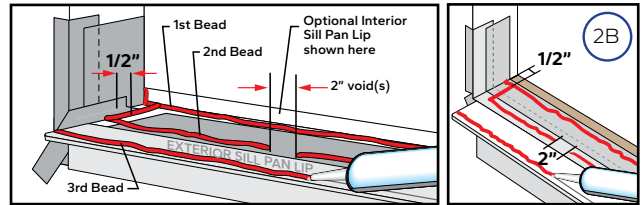

NOTICE Ensure the sealant is compatible with the water-resistant coating.

150 Series / Encompass Doors without sill nail fins use steps C-F:

C. **Remove the sill track** by beginning at one end and carefully pulling it up. This will expose the slide panel pocket.

Note: A hooked tool like an Allen wrench will easily get the track started.

D. **Drill 3/16" holes through the sill every 18",** starting from each corner and 1-3/16" from the interior. Counter-drill with a 3/8" bit through the first wall of the door frame only. Use a drill guide set 1/4" from the end of the bit to prevent drilling through the second wall.

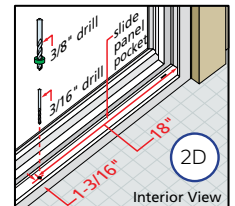

E. **Dry fit the door.** Make sure that the door is plumb, square and level. Mark and drill anchor locations. Mark the interior of the door frame at the sill to show a boundary for sealant placement. Carefully remove and set the door aside.

F. **Apply 2 continuous 1/4" to 3/8" diameter beads of sealant** across the sill of the opening and 6" up the jambs, towards the interior side of the door (between the anchor holes and interior edge of door). DO NOT apply sealant between the anchor holes and the exterior side of the sill plate or floor.

NOTICE Failure to properly seal the sill attachment screws and sill plate may allow water to penetrate the interior of the home.

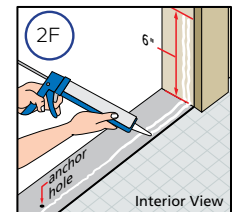

G. **Center the bottom of the door in the opening** and tilt the door into position. Do not slide the door into the opening. Sliding will damage the sealant lines.

Check the jambs for plumb and confirm there is room for shimming between the jambs and opening on each side.



NEW CONSTRUCTION INSTALLATION IN MASONRY CONSTRUCTION FOR BLOCK FRAME SLIDING DOORS (OR THE INSTALLATION OF NEW BLOCK FRAME DOORS INTO MASONRY OPENINGS)

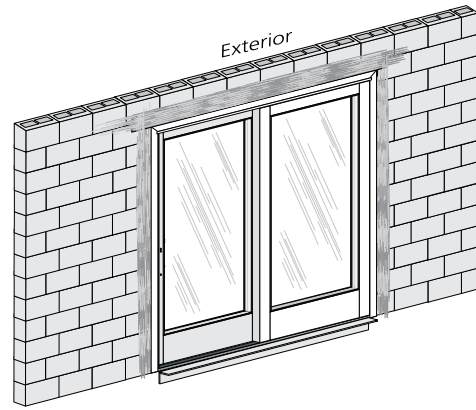
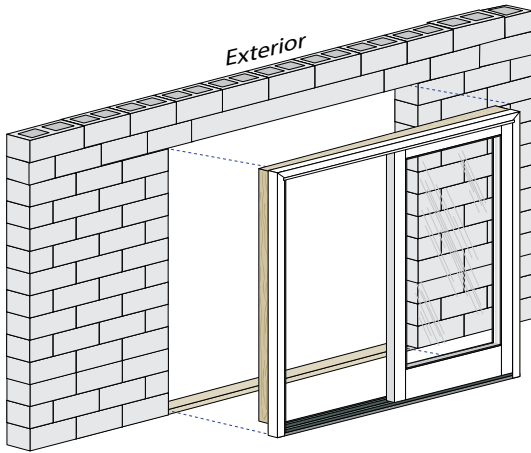

2 SET AND FASTEN THE DOOR CONTINUED

- H. Walk across the sill to compress the sealant and confirm the frame is firmly on the opening sill.
- I. Pre-drill and drive two screws one near the bottom of each side of the door through the frame or clip. (See anchor instructions at the end of this booklet for screw or clip spacing.)
- J. Plumb and square the door. Place shims near the top corners, as necessary. Shims must be flat and support the frame to the exterior the full wall depth. On the interior, stop shims 1/2" short to allow for a continuous interior sealant, or seal across shims after trimming flush to the frame.
- K. Drive two fasteners, one near the top corner on each side.
- L. Check the door placement by measuring from the interior surface of the door frame or jamb extension to the interior surface of the wall for consistency.

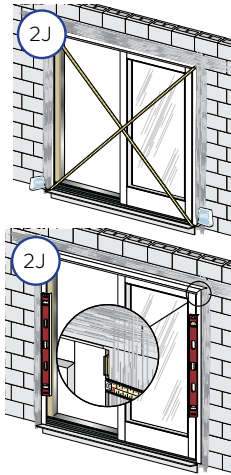

Note: For 250 Series and knock down doors, insert fixed panel. Refer to KD assembly instructions (if applicable). Do not fasten 250 fixed panel until after vent panel is operational.

- M. Anchor the frame. Refer to the anchor page(s). Add additional screws through the frame or attach installation clips as required.

NOTICE Shims are required at each screw location. Refer to the applicable anchor instruction page(s) near the end of this booklet.

- N. Install the sliding panel. From the exterior, tilt the top of the panel and insert it into the top track. Move the bottom of the panel toward the door frame and set it on the bottom track. Be careful not to pinch your fingers between the two panels. DO NOT close the sliding panel until the hardware is installed. The door may lock when closed.

- O. Check door operation.

Reserve and Lifestyle Series Doors: Adjust Vent Lock Tip (if applicable).

Impervia Doors: If Vent Lock does not lock, loosen screws and adjust strike plate locations and re-tighten screws.

NOTICE Adjust shims to correct any issues with plumb, square, operation or reveal.

- P. Adjust the panel height to 1/4" clearance from bottom of panel to sill track by removing the hole cover (if applicable) and using a #2 Phillips screwdriver to turn the roller adjustment screw clockwise (raise) or counterclockwise (lower).

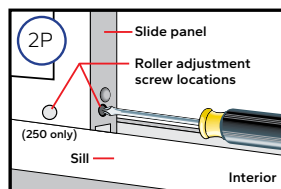

Note: Reinstall the hole cover (if applicable) once adjustments are complete.

2 SET AND FASTEN THE DOOR CONTINUED

NOTICE Check vent panel to frame and vent panel to fixed panel reveal.

NOTICE For doors with heavy laminate or triple-pane glass use a small pry bar to raise the panel while turning the adjustment screw. This will prevent the threads from being stripped (applies to all methods).

- Q. Install the bumpers (if applicable). Refer to the anchor instructions at the end of this booklet.
 - R. Install the handles. Refer to the instruction in the hardware box.
 - S. Install the strikes/keepers. Refer to the provided instruction or to the anchor page(s) and adjust as required to ensure handle locks and operates correctly.
- 250 Series Doors:** Install the keeper after the sliding panel is confirmed to operate and lock. Then fasten the fixed panel to the door frame.

IMPORTANT Install the vent lock strike plate. Refer to the Secure Vent Lock Strike Plate installation document located in the hardware box.

- T. Install vent panel retainers (if applicable) or reinstall if the vent panel was removed during installation. Refer to the instructions included in the panel retainer hardware package.

WARNING Panel Retainer **MUST** be installed to reduce risk of serious injury or death from a falling door panel. If panel retainer is lost or damaged, DO NOT INSTALL DOOR. Contact your Local Pella Seller or Pella Customer Service (877) 473-5527 for replacement.

3 SEAL THE DOOR

- A. Install interior sealant. Refer to the interior sealant instructions at the end of this booklet. Use additional sealant around clips to prevent air and water infiltration.
- B. Attach sill support or wood blocking. If support was not attached before setting the door and the concrete does not provide support for the exterior of the door sill.
- C. Install exterior sealant (after wall cladding and head flashing is installed) between the door frame and the finished wall material. Refer to the exterior sealant instructions at the end of this booklet.

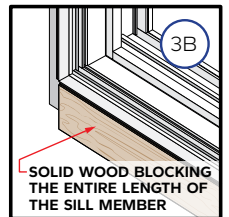

Note: If interior or exterior sealants contact the water-resistant coating, ensure capability.



ANCHOR INSTRUCTIONS - BLOCK FRAME INSTALLATION METHODS FOR CLAD EXTERIOR PELLA® RESERVE AND PELLA® LIFESTYLE SERIES SLIDING PATIO DOORS

Note: Standard performance only. Additional anchoring may be required for Performance Upgrade or to comply with local building code requirements.

Location	Anchor Type		Instructions	Drawing	
	Wood	Masonry			
Head	Vent Lock Strike	#10 x 2-1/2" (provided)	Pilot drill using 5/32" bit and drive (1) screw through Vent Lock Strike.	B	
	Fixed Panel Bracket		Pilot drill using 5/32" bit and drive (1) screw through Fixed Panel Bracket.		
	Frame Screws	#10 x 2-1/2" PH	Pilot drill using 5/32" bit and drive screws 6" from corner.	C	
	Interlocker Frame Screws*		OX or XO and Performance Upgrade or over 95.25" x 95.5" only: Add screws 5" on either side of Vent Lock Strike and Fixed Panel Bracket screws.	C.1	
	Joiner Frame Screws		OXO or OXXO only: Pilot drill using 5/32" bit and drive screws at midpoint of joiner (OXXO) or through joiner part (OXO) and 5" either side of joiner midpoint.	C.2	
Installation Clips	(2) #6 x 1-1/4"	3/16" x 1-1/2"	Slide clip into slot from end and adhere to frame with tape 6" from corner.	D	
Jamb	Lock Strike (OX or XO)	#8 x 3" (provided)	3/16" x 3"	Complete per each strike. Pilot drill using 5/32" bit and install (2) installation screws diagonally. Install cover after screws.	E
	Lock Strike (OXO or OXXO)	#8 x 2-1/2" (provided)	N/A	Install (2) short screws diagonally. Install cover after screws.	E.1
	Frame Screws	#10 x 2-1/2" PH	1/4" x 2-1/2"	Pilot drill using 5/32" bit and drive screws 6" from corner and 20" on center.	C
	Installation Clips	(2) #6 x 1-1/4"	3/16" x 1-1/2"	Slide clip into slot from end and adhere to frame with tape 6" from corner and 20" on center.	D
Sill	Frame Screws*	#8 x 3" FH or #10 x 2-1/2" FH	1/4" x 2-1/2"	Performance Upgrade or over 95.25" x 95.5" only: Use factory pre-drilled holes (if applicable). Pilot drill with 1/8" bit and apply sealant before driving screws. Not required if Standard Performance OX or XO and 95.25" x 95.5" or under.	F

Use corrosion resistant fasteners compatible with construction materials. Shim as required at anchor locations.

For light gauge steel framing, use #10 self-tapping screws with minimum 3 thread embedment.

*Additional anchors required for Performance Upgrade or frame sizes exceeding 95.25" x 95.5".

*For Performance Upgrade, install the Performance Upgrade Interlocker. Refer to provided instructions.

Units with Pella EnduraClad exterior trim without fins or pre-punched holes must be anchored with frame screws or installation clips.

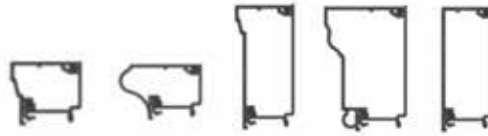

Elevation View

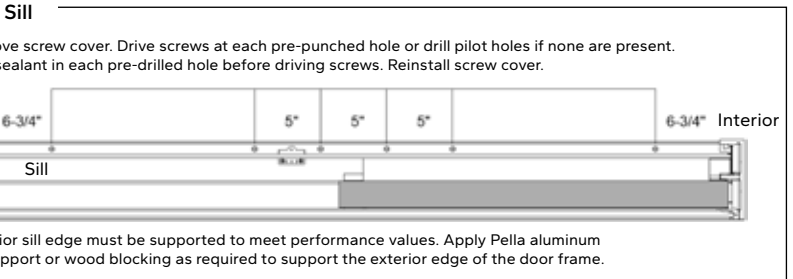
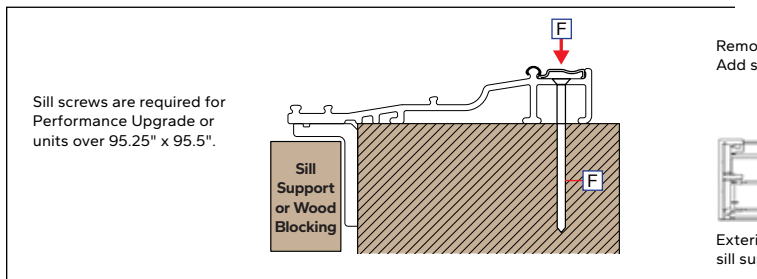
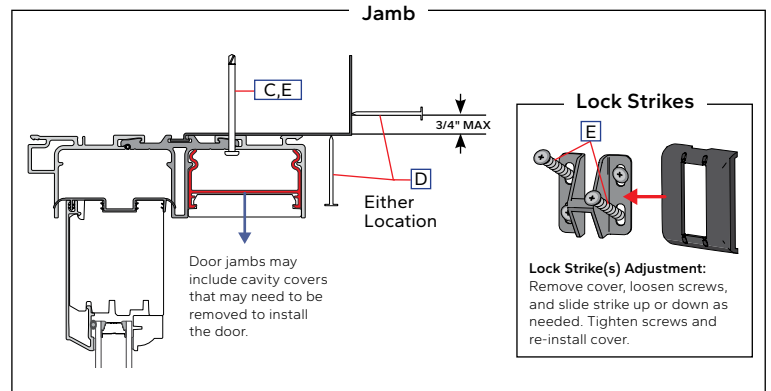
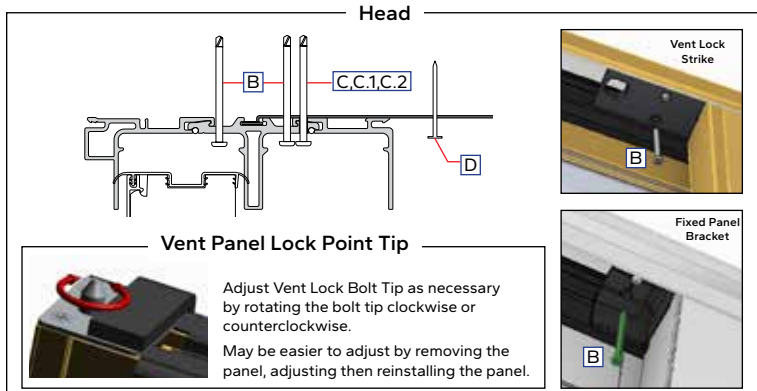
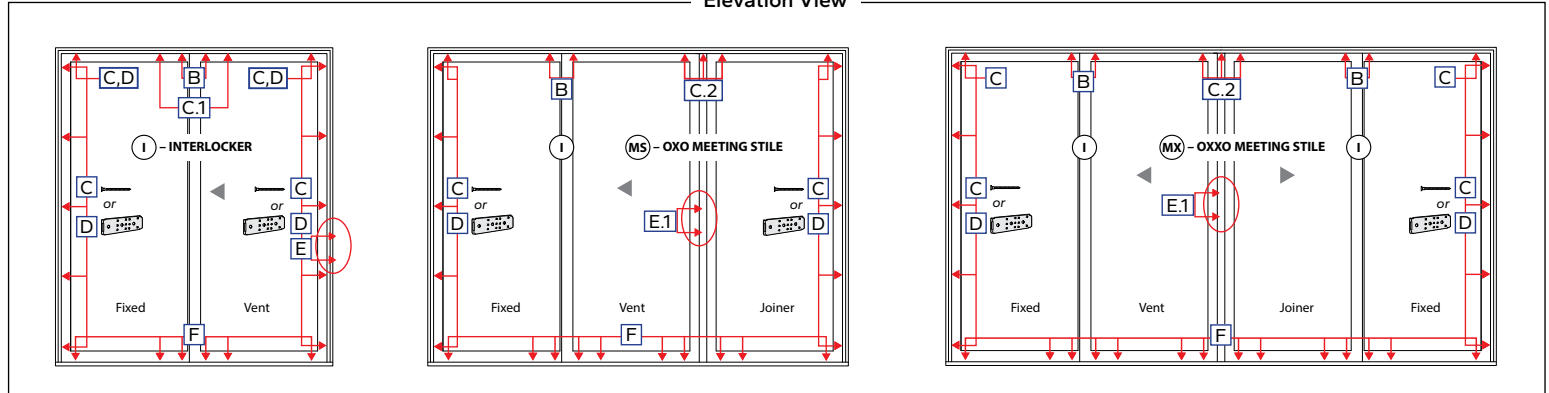
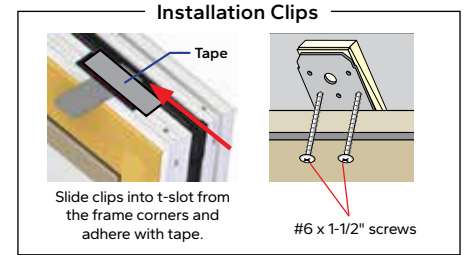



ANCHOR INSTRUCTIONS – BLOCK FRAME INSTALLATION METHODS FOR PELLA® 150 SERIES AND ENCOMPASS BY PELLA® SLIDING PATIO DOORS

Note: Standard performance only. Additional anchoring may be required for performance upgrade, impact-resistant products or to comply with local building code requirements.

Product	Location	Anchor Type		Instructions	Illustration
		Wood	Masonry		
Pella® 150 Series and Encompass by Pella	Head / Jamb / Sill Frame Screws	#10 x 2" Corrosion Resistant (provided)	N/A	Pre-drill through both walls with 5/32" pilot hole. Drill through the first wall only with a 3/8" bit. Then drive screws. Refer to the illustrations for location and spacing. Screws through the sill require sealant and self-sealing washer.	A, B
	Head and Sill – Interlockers only	#10 x 2" Corrosion Resistant (provided)	N/A	Pre-drill through both walls with 5/32" pilot hole. Drill through the first wall only with a 3/8" bit. Then drive screws. Refer to the illustrations for location and spacing. Screws through the sill require sealant and self-sealing washer.	A, B
	Jamb	Strike / Lock / Keeper	#6 x 1/2" starter screw and 3" screws (provided)	1/4" x 3-1/2" Masonry Screw	Refer to installing the keeper instructions and illustrations below.

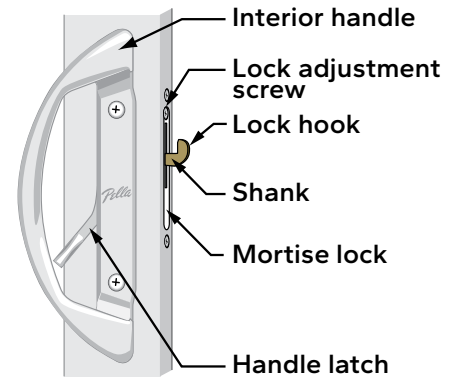
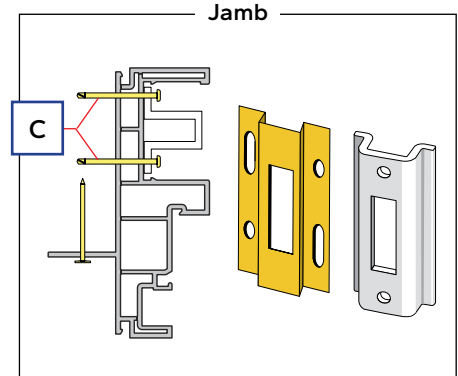
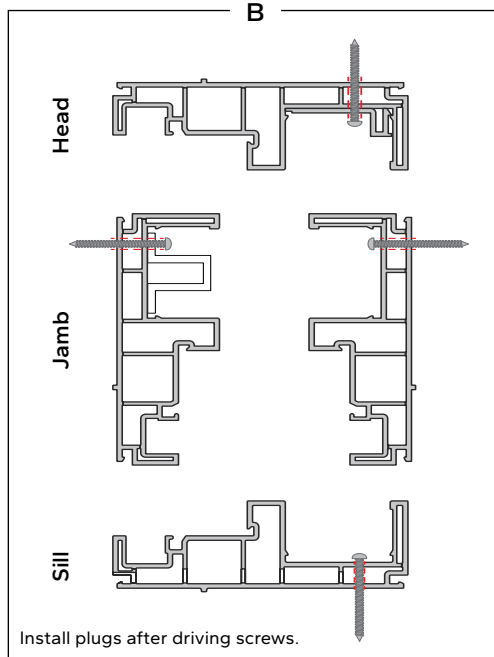
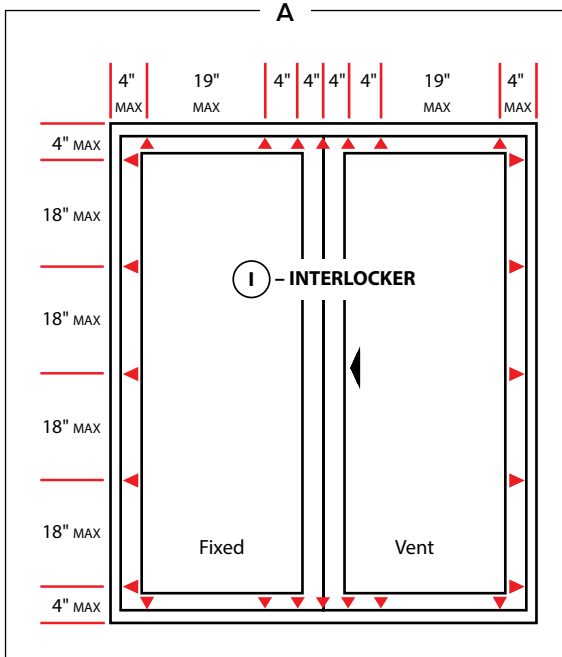

KEEPER INSTALLATION FOR ENCOMPASS BY PELLA® AND PELLA® 150 SERIES:

- Identify the keeper** in the hardware package and perform the keeper attachment steps based on which keeper is in the package. Determine the keeper location by opening the panel a few inches and extending the lock hook. With a pencil, mark the location on the jamb directly across from the top of the shank.
- Place the keeper with 4 screw holes** on the jamb so the top of the slot is aligned with the pencil mark. Attach by inserting a #6 x 1/2" starter screw into one of the slotted keeper holes.
- Place the keeper with 2 screw holes** on the jamb by "snapping" it into the frame jamb at the desired location. The keeper may be moved up or down to align with the pencil mark. The keeper will stay in position until attached with screws.
- Insert a shim** between the frame jamb and the rough opening at the keeper location.
- Adjust the lock hook** by turning the door lock adjustment screw clockwise to loosen or counter-clockwise to tighten until the mortise lock is aligned properly, the door locks easily, and there is less than 1/16" movement when the door is locked.
- Install the keeper** by inserting 3" long screws (provided) through the keeper holes, the shim and into the rough opening frame members. Remove the starter screw from the 4 screw hole keeper and replace it with a 3" long screw.

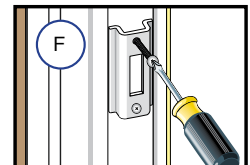
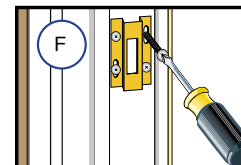
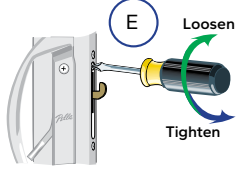
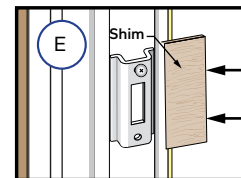
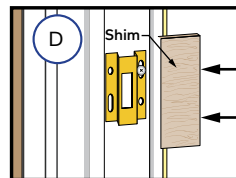
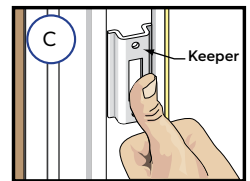
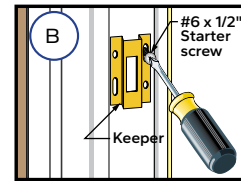
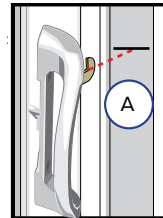



ANCHOR INSTRUCTIONS – BLOCK FRAME INSTALLATION METHODS FOR PELLA® 250 SERIES SLIDING PATIO DOORS

Note: Standard performance only. Additional anchoring may be required for performance upgrade, impact-resistant products or to comply with local building code requirements.

Location		Anchor Type		Instructions	Drawing
		Wood	Masonry		
Head and Jamb Frame Screws		#10 x 3" Pan Head (provided)	3/16" x 3"	Locate screws 3" from corners and 16" on center. Shim at each screw. Use the score line in the frame as a guide, pilot drill with a 1/8" bit into the opening then drill a 3/8" hole through the first wall only and drive screws. Place caps or plugs (provided) over screw holes (optional).	B
Head Secure Vent Lock Strike				Refer to the provided Secure Vent Lock Strike installation instruction located in the hardware box.	B.1
Jamb	Lock Strike / Keeper (OX, XO, OOX, or XOO)	#10 x 1-3/4" (provided)	N/A	Refer to provided instructions. Shim between the frame and the opening and drive three screws through the keeper and into the opening.	C
	Astragal / Meeting Stile Keeper (OXO or OXXO)			Refer to provided instructions.	C.1
	Fixed Panel Frame Screws			#8 x 1" Flat Head (provided)	Place screws evenly spaced into the fixed jamb frame leg where the weatherstrip is located.
Head / Sill	OOX/XOO Fixed Panel Screws	#8 x 3/4" (provided)		Place screws 1/2" from the edge of the panels at the interlocker ends through the head and sill frame legs where the weatherstrip is located.	E
Sill	Frame Screws (optional)	#10 x 3" Pan Head	3/16" x 3"	Optional to maintain sill embedment into sealant, pre-drill with 1/8" bit, add sealant, and drive screws. Remove roller track, install screws, reinstall track, seat with block and rubber mallet.	F

Use corrosion resistant fasteners compatible with construction materials.

For light gauge steel framing, use #10 self-tapping screws with minimum 3 thread embedment.

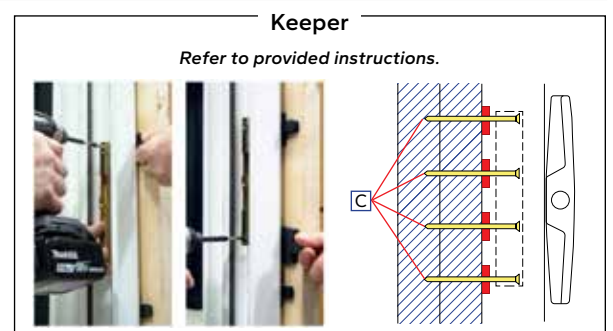
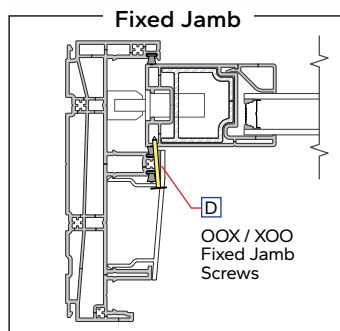
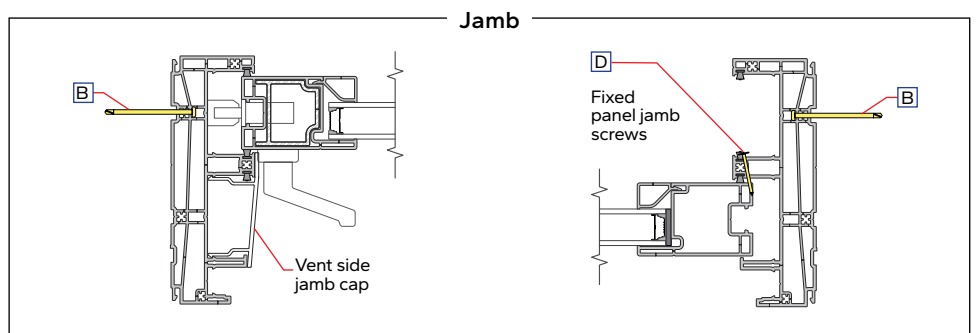
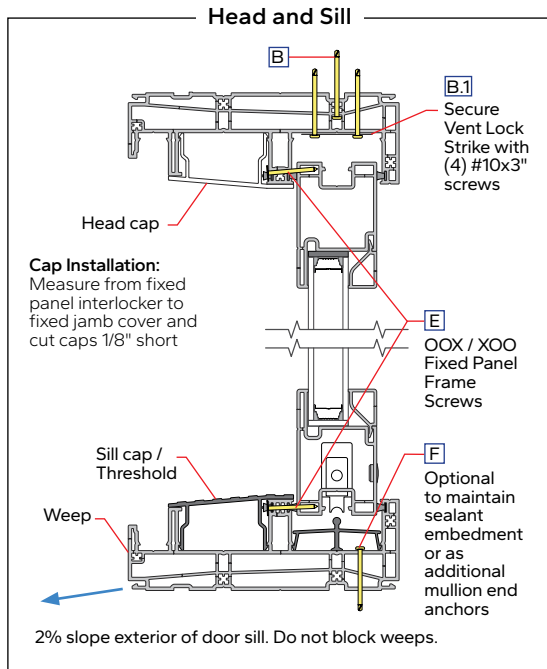
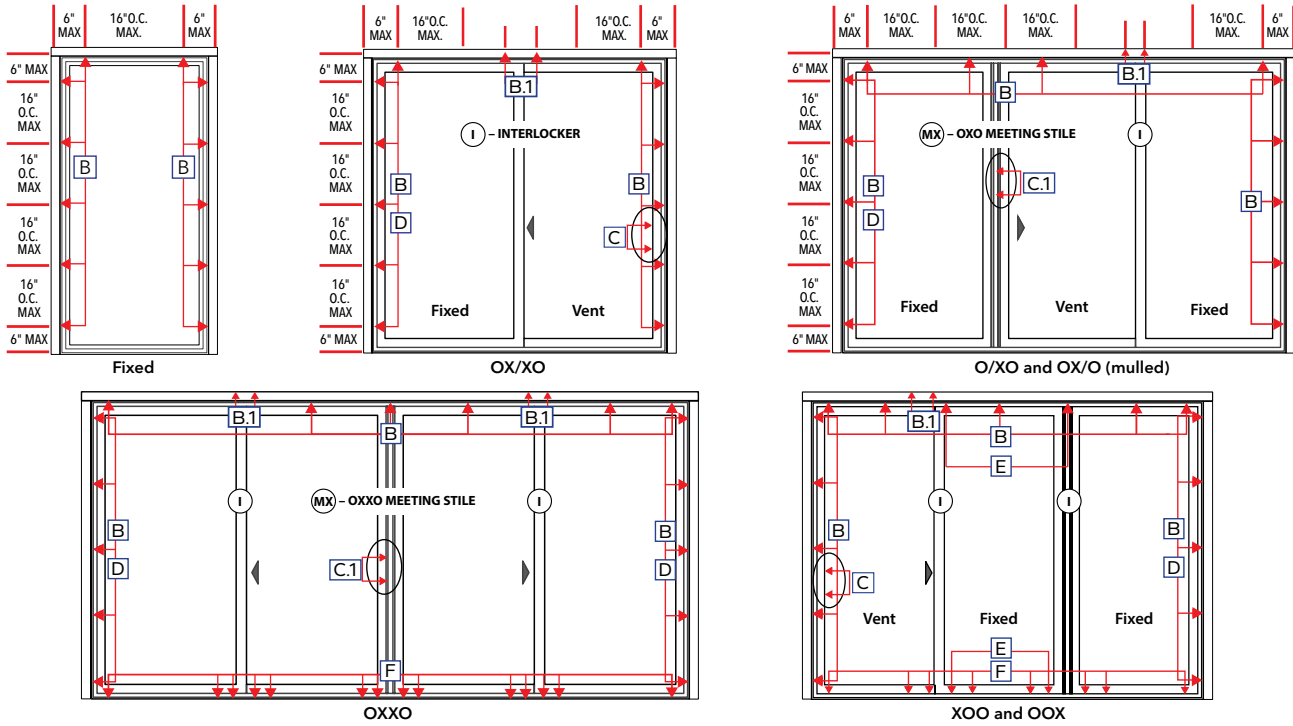



ANCHOR INSTRUCTIONS - BLOCK FRAME INSTALLATION METHODS FOR PELLA® IMPERVIA SLIDING PATIO DOORS

Note: Standard performance only. Additional anchoring may be required for performance upgrade or to comply with local building code requirements.

Location		Anchor Type		Instructions	Illustration
		Wood	Masonry		
Head/ Jamb	Nail Fin*	2",11 Ga. Roofing Nail	N/A	Within 3.5" from each corner and 7" on center (every other pre-punched hole). All PG 35 and PG 50 up to 71.25" x 81.50" frame size.	A
	Nail Fin with Frame Screws	#10 x 3" (provided)	3/16" x 1-3/4" Masonry Screw	Use factory-drilled installation holes if present. Drill holes through both walls and into the rough opening using a 1/8" bit then drill a 3/8" hole through the first wall only.	
	Frame Screws	#10 x 3" (provided)	3/16" x 1-3/4" Masonry Screw	Required to meet PG 50 if >71.25" x frame width or >81.50" frame height.	
	Installation Clips	#8 x 1 1/4"	3/16" x 1 1/2"	Slide clips into slot from frame ends. Adhere clip with tape. Not applicable with nail fin	
Sill	Frame Screws	#8 x 3" (provided)	3/16" x 2 1/2" Masonry Screw	Remove inner sill cover. Use factory-drilled installation holes, pilot with 1/8" bit into rough opening. Apply sealant in each hole before driving screws.	C
	Vent Panel Retainer Support	#8 x 3" (provided)	3/16" x 2 1/2" Masonry Screw	Apply sealant in each hole before driving screws. Reinstall sill cover.	
	Fixed Panel Structural Bracket	#10 x 3" (provided)	3/16" x 2 1/2" Masonry Screw	Remove one factory-installed screw first. Pre-drill 3/16". Pilot with 1/8" bit into rough opening. Apply sealant in each hole before driving screws.	
	Aluminum Support	#8 x 3/4" (provided)	NA	Available separately - consult your local Pella representative.	
Mullions*		#10 x 3"	3/16" x 1-3/4" Masonry Screw	Head: Drill holes through both walls and into the rough opening using a 1/8" bit then drill a 3/8" hole through the first wall only. Add sealant prior to driving screws at the sill.	B
Lock Strike		#8 x 3"	3/16" x 1-3/4" Masonry Screw	Grade 40 Security: Install (4) installation screws per strike. Grade 10 Security: Install (2) installation screws (diagonally) per strike. Pilot all installation screw locations with 1/8" bit into rough opening.	D

*For light gauge steel framing, use #10 self-tapping screws.
**Anchor through structural mullion end anchors, if present.

***Impact-Resistant products must be installed with frame screws. Fin fastening (if applicable) is optional for flashing purposes. Refer to Florida Product Approval documents (if applicable).

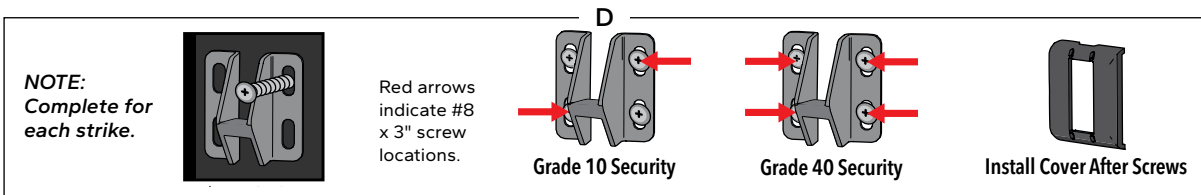
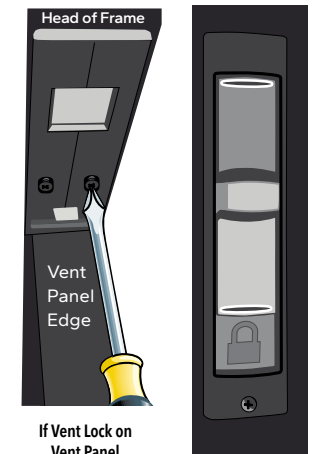
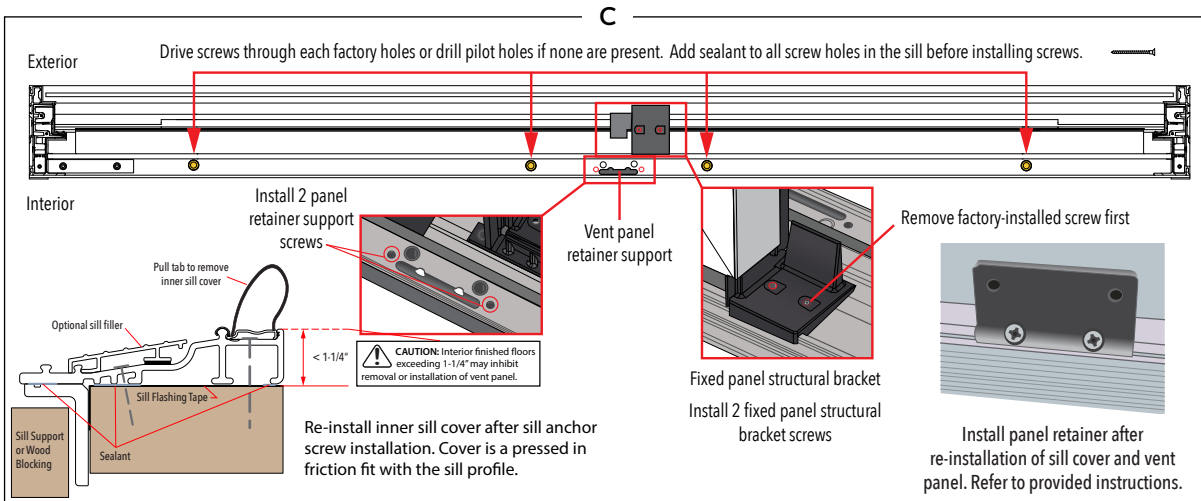
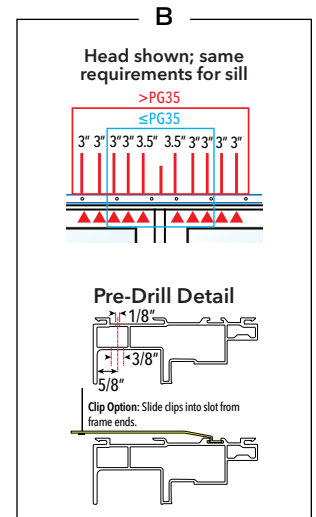
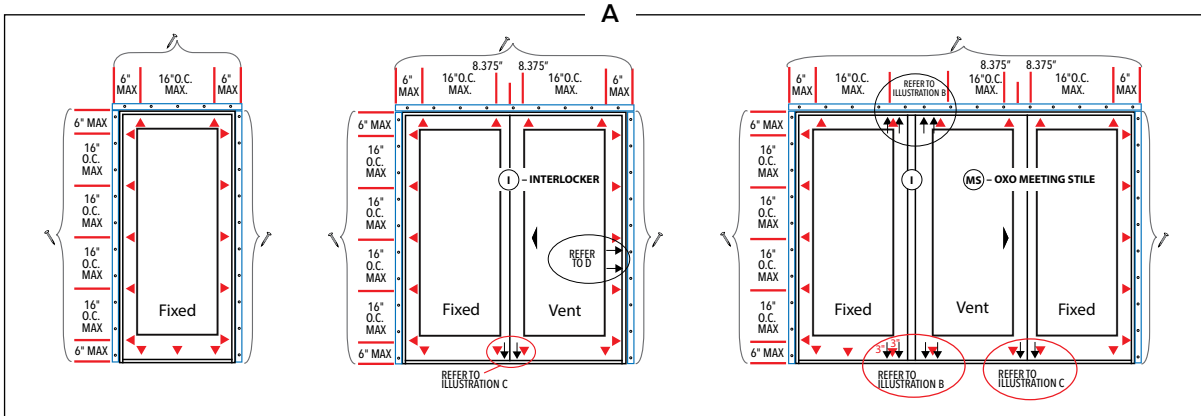



REVERSING DOOR SLIDE FOR SLIDING PATIO DOORS

Note: Doors with Blinds-Between-the-Glass are not reversible.

REVERSING DOOR SLIDE FOR ENCOMPASS BY PELLA® AND PELLA® 150 SERIES:

- A. **Remove the sill and screen tracks from the door.** (Use an Allen wrench or small hook to begin removal.)
 - B. **Rotate the main frame 180°** (so the sill becomes the head). Snap the sill and screen tracks into place at the bottom of the door. Carefully lay the panel on saw horses or a clean surface.
 - C. **Extend the lock hook** and clamp the lock hook with the vise grip.
- Note: Use of the vise grip on the lock hook will prevent the mortise lock from falling when the lock mounting screws are removed.
- D. **Remove the door handle** by removing the two attachment screws.

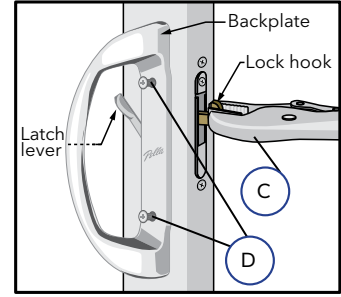

- E. **Remove the mortise lock.** Remove the two screws that attach the lock assembly to the door panel. Work the lock down, then tilt it out and pull up.

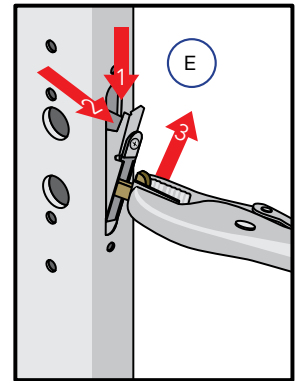
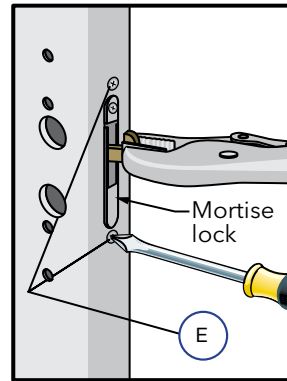

- F. **Rotate 180° and reinstall the lock.** Insert the mortise lock into the door panel with the lock adjusting screw positioned at the bottom, then tilt the top in and lift the lock into position. Insert the two mounting screws into the lock mounting holes.

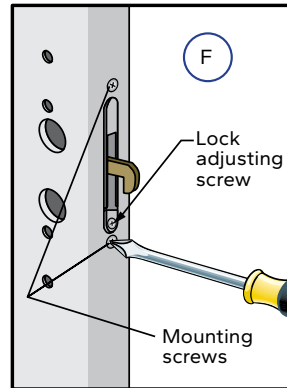

- G. **Rotate the handle 180°** and install the door handle by inserting the two backplate screws through the door panel and into the exterior handle.
- Note: Rotating the handle will result in "Pella" script being upside down. A new handle must be ordered for "Pella" to be in correct orientation.
- Note: The latch lever must engage the slot in the side of the mortise lock assembly.

- H. **Remove the bottom rollers** from the slide panel by removing the upper screw. Reinstall the rollers in the opposite end of the door panel.

- I. **High Performance Doors only:** Remove the blocks from the top rail of the door panel and reinstall them at the opposite end of the panel.
- J. **High Performance Doors only:** Move the frame exterior vent plugs (white foam rods) from the head of the frame to the opposite side of the frame. A soap solution may be needed as a lubricant for re-installing the plugs.

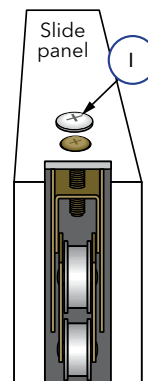



Interior Sealant Instructions

CAUTION Continuous backer rod (as necessary) and a high quality, low-odor interior sealant such as Pella Window and Door Installation Sealant (or equivalent) is recommended for commercial or high performance installations to create the continuous interior seal. Follow the directions on the cartridge. For standard performance or products with factory applied jamb extensions, use low pressure polyurethane insulating foams. Follow the directions on the can. Do not use high pressure or latex foams. Fiberglass batt or similar insulation is not recommended as it can absorb water and does not act as an air seal.

- A. **Insert the nozzle or straw** between the rough opening and door frame from the interior. Use a pliers (if necessary) to compress the end of a straw tube to allow it to fit in tight openings.
- B. **Place a 1" deep bead of foam approximately 1" from the interior of the frame** to allow for expansion. **DO NOT** fill the entire depth of the rough opening cavity.

Note: Apply foam between the frame and rough opening, NOT between jamb extensions and the rough opening.

- C. **Re-Check door operation and remove remaining shipping spacers** after foam installation. Excess foam may be removed with a serrated knife after it cures.
- D. **To ensure a continuous interior seal**, apply sealant over or around any shims or clips interrupting the foam seal.
- E. **Place a continuous bead of sealant across the inner sill at the intersection of the door sill and subfloor.** Continue the sealant 6" up each jamb.

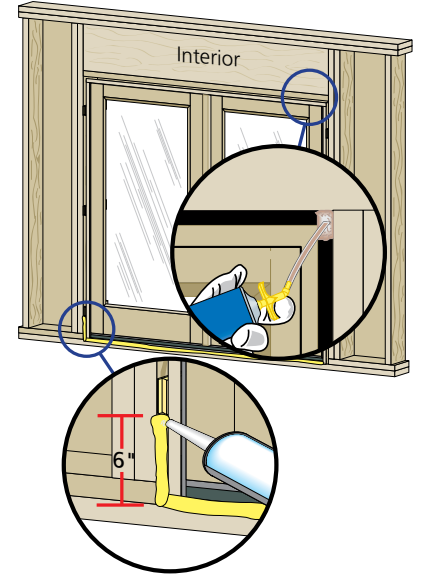

Exterior Sealant Instructions

CAUTION Use a high quality, multi-purpose exterior sealant such as Pella Door and Door Installation Sealant. Follow the directions on the cartridge.

When applying siding, brick veneer, flashing, or other exterior finish materials, leave adequate space between the door frame and the material for sealant application of sealant.

- A. **Insert backer rod 3/8" deep** in the space around the door. Backer rod adds shape and controls the depth of the sealant line.
- B. **Apply a continuous bead of sealant to the entire perimeter of the door.**
- C. **Shape, tool and clean excess sealant.** When finished, the sealant should be the shape of an hourglass.

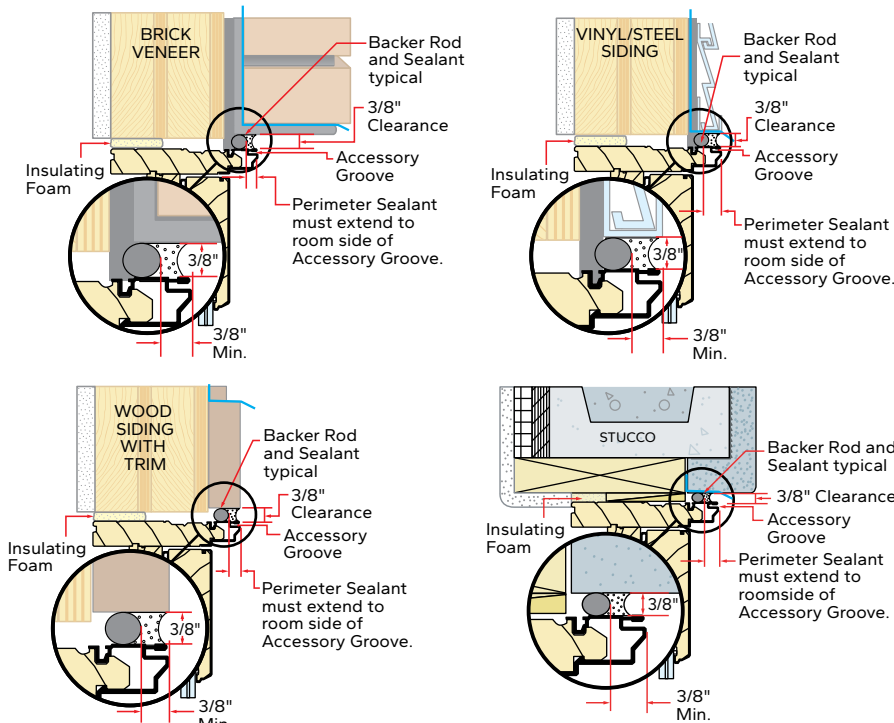
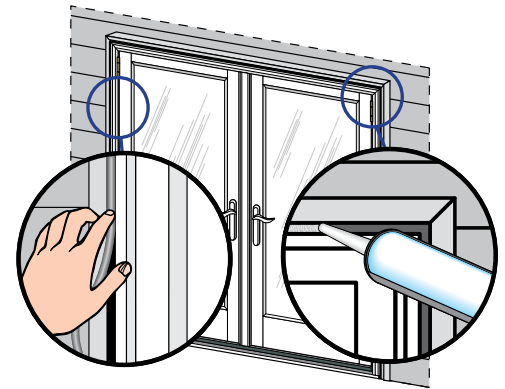



OPTIONAL SILL PAN INSTRUCTIONS

NOTICE The method of pan construction, flashing, and sealant application may vary depending on the design of the opening sill and exterior landing surface conditions. It is important to consider the exposure to weather, the exterior landing surface's proximity to the door sill, and to confirm impervious exterior surfaces properly slope away from the door.

A. **Cut the sill pan** to the width of the rough opening plus 2".

Note: The 2" added onto the rough opening width is for a 1" bend on each end.

B. **Make a 1" cut** in each fold at both end of the sill pan.

Note: These cuts will allow the edges of the sill pan to be bent.

C. **Cut 1" off each end** of the interior sill pan lip.

D. **Bend each end** of the center panel up.

E. **Install the sill pan** by sliding into place until the exterior sill pan lip is flush with the exterior of the rough opening.

F. **Apply sill flashing tape.** Cut a piece of flashing tape 2" longer than the opening width. Apply at the bottom of the opening, covering the exterior sill pan lip as shown.

Note: If applicable, apply spray adhesive to building felt prior to applying the flashing tape.

G. **Cut a piece of flashing tape** to the width of the opening. Install tape to the sill pan and overlap the flashing tape from step 1F by 1". If needed add a second or third piece of flashing tape until the sill pan is covered to the interior sill pan lip.

Note: The purpose of this tape is to seal the sill screws when installing the door.

H. **Cut two 9" pieces of flashing tape** with a 1" x 3" tab at the bottom, on opposite corners as shown.

I. **Apply the tabbed 9" pieces of flashing tape.** The tape is applied so 2" will cover the inside of the rough opening and lap over the side flange of the sill pan. The 1" x 3" tab laps over the bottom flashing tape as shown.

J. **Cut two 6" pieces of flashing tape** and apply to each side of the rough opening, overlapping the first piece by 1" and lapping the bottom over the side flange of the sill pan as shown.

K. **Cut two pieces of flashing tape 1-1/2" x 6"** and apply to the bottom corners of the opening by beginning in the corner of the sill pan, with 3/4" of the tape applied to the sill pan and 3/4" of the tape applied to the side flange. The remainder of the tape is to be at a 45 degree angle onto the exterior.

L. **Attach the aluminum sill support** or wood blocking to the exterior of the box plate to support the edge of the door sill. Place the sill support flush with the subfloor.

