

## IMPORTANT SAFETY AND PRODUCT INFORMATION – DOORS

**Safety Alert Symbol Reference:** These symbols are intended to alert you to potential injury hazards and information. Obey all safety messages.

**COULD**

Result in:



**COULD**

Result in:



**COULD**

Result in:



**COULD**

Result in:



To ensure safety and security and help prevent property damage, including possible damage to your door, close and lock windows and doors any time they are not being used for venting on a nice day, and particularly during high winds or rain.



Many doors in older homes are painted with lead-based paint. Removal of old doors may disturb this paint. Proper precautions must be taken to minimize exposure to dust and debris. Consult state or local authorities and/or go to [www.epa.gov/lead](http://www.epa.gov/lead) for more information.

**NOTICE**

Pella products must be stored in an upright, level position not exposed to weather. The storage must be ventilated and provide protection from direct sunlight and excessive temperature.

**IMPORTANT NOTICE**

**Because all construction must anticipate some water infiltration, it is important that the wall system be designed and constructed to properly manage moisture.** Pella Corporation is not responsible for claims or damages caused by anticipated and unanticipated

water infiltration; deficiencies in building design, construction and maintenance; failure to install Pella products in accordance with Pella's installation instructions; or the use of Pella products in wall systems which do not allow for proper management of moisture within the wall systems. The determination of the suitability of all building components, including the use of Pella products, as well as the design and installation of flashing and sealing systems are the responsibility of the Buyer or User, the architect, contractor, installer, or other construction professional and are not the responsibility of Pella.

Pella products should not be used in barrier wall systems which do not allow for proper management of moisture within the wall systems, such as barrier Exterior Insulation and Finish Systems (EIFS) (also known as synthetic stucco) or other non-water managed systems. Except in the states of California, New Mexico, Arizona, Nevada, Utah and Colorado, Pella makes no warranty of any kind on and assumes no responsibility for Pella windows and doors installed in barrier wall systems. In the states listed above, the installation of Pella Products in barrier wall or similar systems must be in accordance with Pella's installation instructions. Product modifications that are not approved by Pella Corporation will void the warranty.

**CARE AND MAINTENANCE:** Refer to the Pella Owner's Manual. Visit [www.pella.com](http://www.pella.com) or your local retailer for more information.

**CLEANING INSTRUCTIONS:** Refer to the Pella Owner's Manual for comprehensive maintenance and cleaning information. Visit [www.pella.com](http://www.pella.com) or your local retailer for more information.

**NOTICE**

DO NOT apply any other types of film to the glass. Doing so could void product warranty.

**NOTICE**

DO NOT use abrasives. DO NOT scrape or use tools that might damage the surface.

**NOTICE**

DO NOT use inappropriate solvents or brickwash or cleaning chemicals. If you do, permanent damage can result and the product failure, loss or damage would not be covered by the Limited Warranty.

**FINISHING INSTRUCTIONS (WOOD PATIO DOORS AND FIBERGLASS ENTRY DOORS):** Paint or finish immediately after installation.

If products cannot be finished immediately, cover with clear plastic to protect from dirt, damage and moisture. Remove any construction residue before finishing. Sand all wood surfaces lightly with 180 grit or finer sandpaper. DO NOT use steel wool. BE CAREFUL NOT TO SCRATCH THE GLASS. Remove sanding dust. Pella products must be finished according to these instructions; failure to follow these instructions voids the Limited Warranty. Finishing panel edges is optional for Patio Doors.

**NOTICE**

To maintain proper product performance do not paint, finish or remove the weatherstripping, mohair dust pads, gaskets or vinyl parts. Air and water leakage will result if these parts are removed. After finishing, allow venting Doors and doors to dry completely before closing them. If paint, stain or finish gets on the weatherstripping, wipe it off immediately with a damp cloth.

**Panel Cleaning and Prep Instructions for Unfinished or Primed Panels:** Dry wipe dust from doors gently. Examine door for possible smudges or fingerprints made from normal handling or construction. To remove smudges, lightly wipe surface with warm water. DO NOT sand surface of fiberglass panel. Scuff sand with light grade sand paper or abrasive pad (220 grit or higher). Rinse surface with mineral spirits for fiberglass panels and warm water for steel panels. Let door and sidelight surfaces dry completely before applying finish. Finish the door panels as soon as possible after installation.

**STAINING FIBERGLASS PANELS OR UNFINISHED INTERIOR FRAME MEMBERS:** Fiberglass door and sidelight panels may be stained with a gel stain if a wood look is desired. Pella offers stain kits in a variety of colors. Apply and finish per the stain kit manufacturer's instruction. Ensure that all exposed panel edges are finished to minimize the chance of damage.

Unprimed interior frame parts may be stained with wood stains and should be finished with a minimum of two coats of a clear polyurethane finish. DO NOT bridge the top coat between the outer edge of the glazing frame and the door panel.

**Note:** The fiberglass base color tone will vary. This variance is normal and will not impact the stain color of the door.

**PAINTING INSTRUCTIONS:** Wood door frame exteriors, premium steel door panels and sidelights are factory primed. Wood doors require painting immediately after installation. The factory applied primer is not intended for long term exterior exposure. Sand all un-primed interior wood surfaces lightly with 180 grit or finer sandpaper before priming and painting. Fiberglass door and sidelight panels do not require priming. Use two coats of a 100% latex paint that has a good blocking resistance. On units with glass, do not bridge paint between the outer edges of the glazing frame and the door panel. On fiberglass products, brush the paint in the same direction as the simulated wood grain. For entry doors, ensure that all exposed panel edges are finished to minimize the chance of panel damage. Finishing panel edges is optional for Patio Doors.

Pella Corporation is not responsible for interior paint and stain finish imperfections for any product that is not factory-applied by Pella Corporation. For additional information on finishing see the Pella Owner's Manual or go to [www.pella.com](http://www.pella.com).

**NOTICE**









The use of unapproved finishes, solvents or cleaning chemicals may cause adverse reactions with door materials. Pella will not be responsible for problems caused by the use of unapproved materials. If in doubt, contact your local retailer or representative.

**EXTERIOR FINISH OF EXISTING FRAME (POCKET REPLACEMENT):** It is the responsibility of the homeowner, contractor or installer to ensure any exposed unfinished wood is covered or finished. Possible methods include, however are not limited to, covering with aluminum coil stock or painting.



# PREPARING FOR SLIDING DOOR INSTALLATION WITH NAIL FIN

## You will need to supply:

- Moisture resistant shims/spacers 
- 2" galvanized roofing nails (1/4 lb.) 
- #10 x 3-1/2" corrosion resistant wood screws (Performance Upgrade & impact-resistant) 
- Masonry screws for concrete applications (Minimum of 3/16" diameter x 3") 
- Closed cell foam backer rod/sealant backer (21 to 30 ft.) 
- Pella® SmartFlash™ foil backed butyl window and door flashing tape or equivalent 
- Pella Window and Door Installation Sealant or equivalent high quality, multi-purpose sealant. 
- Low Expansion, low pressure polyurethane insulating window and door foam sealant. DO NOT use high pressure or latex foams 
- Sill pan (optional) 6-5/8" x (Rough Opening Width +2)
- Pella aluminum sill support or wood blocking
- Interior trim and/or jamb extensions (15 to 40 ft.)

## INSTALLATION CLIP OPTION:

- 6" or 8" installation clips 
- #6 x 5/8" corrosion resistant flat head wood screws
- #8 x 1-1/2" corrosion resistant screws or 3/16" x 1-1/2" masonry screws

## Tools required:

- Tape measure 
- Level 
- Square 
- Hammer 
- Stapler 
- Sealant Gun 
- Scissors or utility knife 
- Tin Snips 
- Screwdrivers (#2 Phillips with 8" shaft and small flat blade) 
- Drill 
- Drill Bits 13/64" and 1/8" and masonry bit for concrete applications

**WARNING** Installation will require (2) or more persons for safety reasons.

Store doors in upright position, out of direct sunlight.

## ROUGH OPENING VERIFICATION

A. Confirm the opening is plumb and level.

**NOTICE** It is critical the bottom is level and it does not slope to the interior or exterior.

B. Remove dirt, oil or debris from the opening and surrounding wall surfaces.

C. Confirm the door will fit the opening. Measure all four sides of the opening to make sure it is 1/2" to 3/4" larger than the door in both width and 1/2" larger in height. Measure the width and height in several places to ensure the header or studs are not bowed.

**NOTICE** 1-1/2" or more of solid wood blocking is required around the perimeter of the opening. Fix any problems with the rough opening before proceeding.

**NOTICE** It is important to consider the door's exposure to weather, the exterior landing surface type and its proximity to the door sill, and to confirm impervious exterior surfaces properly slope away from the door prior to continuing with installation.

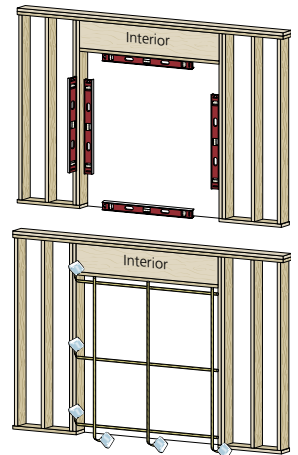

## PREPARE THE DOOR FOR INSTALLATION

A. Remove plastic wrap and cardboard packaging from the door. On laminate units, remove protective film from parts.

B. Inspect the product for any damage such as cracks, dents or scratches. DO NOT install damaged products.

C. Pella Reserve and Pella® Lifestyle Series Sliding doors: Remove the shipping spacers by sliding the movable panel halfway open and take the spacers off the top and bottom of the panel.

**All Doors:** Remove the vent panel prior to installation. You will need to first remove the vent panel retainer near the interlocker on the sill. Then remove the vent panel by opening the panel about 8" then lifting it out of the lower track, tilting the bottom of the panel away from the door frame, and lowering the panel out of the top track. Carefully set the panel aside. Reinstall the vent panel and panel retainer after installation of the door frame.

**For 4 Panel sliding doors shipped in 2 half sections,** complete the field assembly instructions before proceeding.

**Impervia:** Remove the vent panel by opening the panel about 4" then lifting it out of the lower track and tilting the bottom of the panel away from the door frame. Then lower the panel out of the top track. Two shipping spacers will need to be removed from the bottom of the panel. Carefully set the panel aside.

**Encompass by Pella® and Pella® 150 Series doors:** If reversing the door slide, refer to the instructions later in this booklet.

D. Fold out installation fin to 90° (units with fold up fin only). Be careful not to remove or tear the fin corners.

*Note: If the fin is not at 90°, the door will not line up correctly on the interior.*

E. Units with wide EnduraClad Exterior trim and narrow fins with NO pre-punched holes: Install clips or pre-drill holes for frame screws.

See nail fin anchor instruction at the end of this booklet.

Additional preparation may be required for performance upgrade, impact-resistant products or to comply with local building code requirements. See advanced performance or hurricane shield anchor schedule.

F. Read the entire instruction before proceeding.

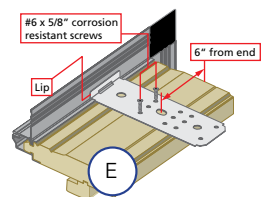
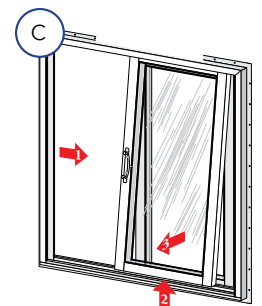

These instructions were developed and tested for use with wall systems designed to manage water. These instructions are not to be used with any other construction methods or door frame types. Installation instructions for use with other construction methods or frame types may be obtained from Pella® Corporation, your local Pella retailer or [www.installpella.com](http://www.installpella.com). Building designs, construction methods, building materials, and site conditions unique to your project may require an installation method different from these instructions and/or additional care. Determining the appropriate installation method is the responsibility of you, your architect, or construction professional.



BY PURCHASING, INSTALLING OR USING PELLA PRODUCTS (INCLUDES PELLA GOODS AND PELLA SERVICES), YOU AGREED TO THE TERMS OF THE LIMITED WARRANTY AND YOU AND PELLA FURTHER AGREE TO ARBITRATE DISPUTES ARISING OUT OF OR RELATING TO PELLA PRODUCTS, AND YOU WAIVE ANY RIGHT TO PARTICIPATE IN A CLASS ACTION RELATED TO PELLA PRODUCTS unless you notify Pella of your decision to opt out of the Arbitration Agreement no later than ninety (90) calendar days from the date you purchased or otherwise took ownership of Your Pella Goods. Opting out of the Arbitration Agreement will not affect the coverage provided by any applicable limited warranty pertaining to Your Pella Products. For opt out information and additional details please read the Limited Warranty and Arbitration Agreement for your Pella Products at [www.Pella.com/arbitration](http://www.Pella.com/arbitration).

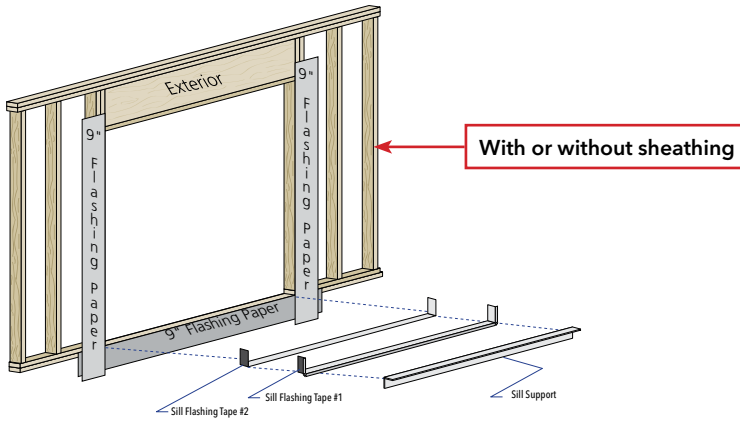

# 1 PREPARE THE OPENING

Refer to the nail fin installation preparation section at the beginning of this booklet.

A. Apply flashing paper at the bottom. Cut one piece of 9" minimum width flashing paper 18" longer than the width of the opening. Staple it flush with the top of the sill plate.

Note: bottom flashing paper is not required on concrete floors.

B. Apply flashing paper to the sides. Cut 2 pieces of 9" minimum width flashing paper 18" longer than the longest straight side of the opening. Center the flashing paper with the opening height and staple one piece flush with the inside edge on both sides. If using an optional sill pan or if the door will be installed on a concrete slab, refer to the instruction page at the end of this book.

C. Cut 2 pieces of flashing tape 12" longer than opening width.

D. Apply sill flashing tape #1 at the sill extending 1" to the exterior and 6" up each jamb.

E. Cut 1" wide tabs at each corner by tearing the foil 1/2" each way from corner.

F. Apply sill flashing tape #2 overlapping tape #1 by 1" minimum. For In-Swing Doors with frame depth greater than 5", add a third piece of flashing tape so it comes within 1/4" of the interior of the door frame.

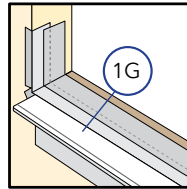
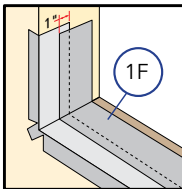
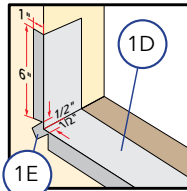
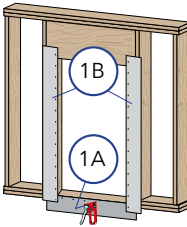

**NOTICE** Press all tape down firmly.

Note: For doors with sill nailing fins, skip to step 2A and install only the interior most bead of sealant.

G. Attach a Pella aluminum sill support or wood blocking flush with the opening sill to support the exterior edge of the door frame.

# 2 SETTING AND FASTENING THE DOOR

For vinyl doors without sill nail fins, skip to step B.

A. Place three 3/8" beads of sealant across the opening sill. Place the interior-most bead 1/2" from where the interior of the door sill will remain after installation. Continue this bead up the sill pan lip, if applicable. Place a second bead beginning from the interior bead 1/2" from each side, out to the exterior of the framing and along the opening. Leave 2" voids 4" from the corner and at the center. Place a third bead where the exterior of the door sill will remain after installation.

Proceed to step 2F.

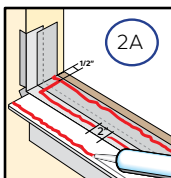
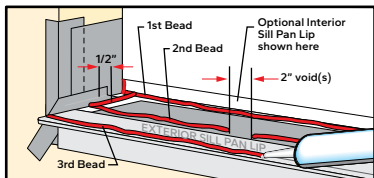

# 2 SETTING AND FASTENING THE DOOR CONTINUED

Vinyl Doors without sill nail fins use steps B-E, all others skip to 2F.

B. Remove the sill track by beginning at one end and carefully pulling it up. This will expose the slide panel pocket.

Note: A hooked tool like an Allen wrench will easily get the track started.

C. Drill 3/16" holes through the sill every 18", starting from each corner and 1-3/16" from the interior. Counter-drill with a 3/8" bit through the first wall of the door frame only. Use a drill guide set 1/4" from the end of the bit to prevent drilling through the second wall.

D. Dry fit the door. Make sure that the door is plumb, square and level. Mark and drill anchor locations. Mark the interior of the door frame at the sill to show a boundary for sealant placement. Carefully remove and set the door aside.

E. Apply 2 continuous 1/4" to 3/8" diameter beads of sealant across the sill of the opening and 6" up the jambs, towards the interior side of the door (between the anchor holes and interior edge of door). DO NOT apply sealant between the anchor holes and the exterior side of the sill plate or floor.

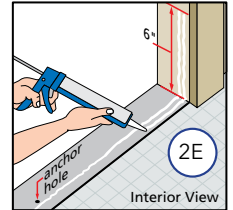
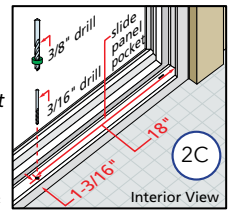

**NOTICE** Failure to properly seal the door sill and any penetrations may allow water to penetrate the interior of the home.

F. Center the bottom of the door in the opening and tilt the door into position. Do not slide the door into the opening. Sliding will damage the sealant lines.

Check the jambs for plumb and confirm there is room for shimming between the jambs and opening on each side.

G. Drive two fasteners, one near each end of the top nailing fin. (See nail fin anchor instructions at the end of this booklet)

H. Plumb and square the door. Place shims at the lock strike. Keep shims 1/2" short of door frame depth. Insert additional shims starting 6" from the bottom as needed to keep jambs straight and plumb.

**NOTICE** Additional shims are required at screw locations for advanced performance, impact-resistant units and combinations. See the nail fin anchor instructions at the end of this booklet.

I. Check the door placement by measuring from the interior surface of the door frame or jamb extension to the interior surface of the wall for consistency. If the dimensions are not equal, confirm the fins are folded fully to 90° (if applicable).

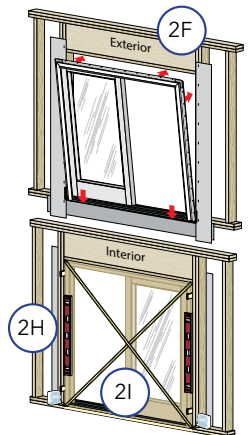

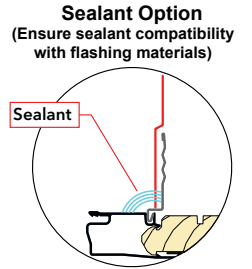
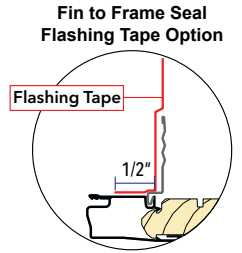
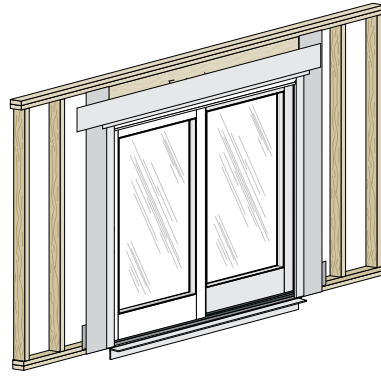
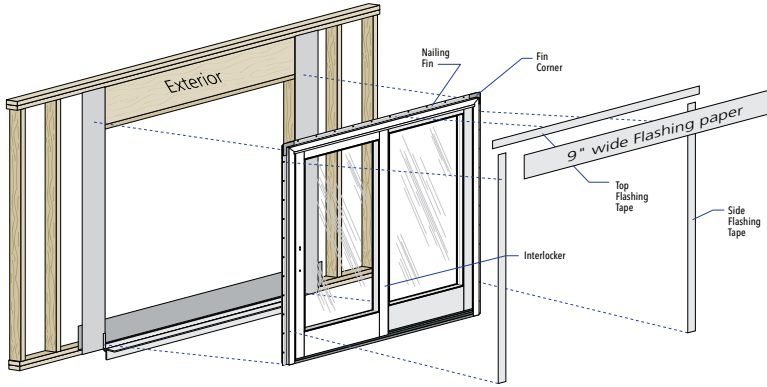

## 2 SETTING AND FASTENING THE DOOR CONTINUED

- J. Drive screw(s) into the keeper strike on the vent side of 2-panel doors.
- K. Finish driving fasteners into the nailing fin. Refer to anchoring instructions at the end of this booklet.
- L. Drive additional anchor screws through the frame. Shim as required at each location. Refer to anchoring instructions at the end of this booklet.
- M. Install the sliding panel. From the exterior, tilt the top of the panel and insert it into the top track. Move the bottom of the panel toward the door frame and set it on the bottom track. Be careful not to pinch your fingers between the two panels. DO NOT close the sliding panel until the hardware is installed. The door may lock when closed.
- N. Check door operation.

**NOTICE** Adjust shims to correct any issues with plumb, square, operation or reveal.

- O. Install panel retainers. Refer to the instructions included in the panel retainer hardware package.  
Install bumpers (if applicable). Refer to the anchor instructions at the end of this booklet.

**WARNING** Panel Retainer **MUST** be installed to reduce risk of serious injury or death from a falling door panel. If panel retainer is lost or damaged, DO NOT INSTALL DOOR. Contact your Local Pella Retailer or Pella Customer Service (877) 473-5527 for replacement.

- P. Install the handles. Refer to the instruction in the hardware box.
- Q. Adjust the panel height to ~1/8" clearance to head of unit by removing the hole cover and using a #2 Phillips screwdriver to turn the roller adjustment screw clockwise (raise) or counterclockwise (lower).

**Impervia Model 2:** Adjust panel height 1/4" clearance from bottom of panel to sill track.

**NOTICE** For doors with heavy impact-resistant or triple pane glass use a small pry bar to raise the panel while turning the adjustment screw. This will prevent the threads from being stripped.

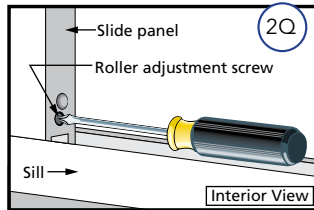

- R. Adjust the footbolt (if applicable) refer to the anchor instructions at the end of this booklet.
- S. Encompass by Pella® and Pella® 150 Series doors: Install the keeper and adjust the lock hook (if necessary). Refer to the anchor instructions at the end of this booklet.
- T. Check door operation by opening and closing the door.

## 3 INTEGRATING WITH THE BUILDING WRAP

**NOTICE** For fold-up or slide-in fins, seal the fin to frame joint by either applying flashing tape 1/2" onto the frame, or sealing the joint with installation sealant after placing flashing tape.

- A. Apply straight side flashing tape. Cut two pieces of flashing tape 4" taller than straight sides. Apply tape over the fin and onto flashing paper. Extend tape 2" above and below straight sides.

- B. Apply top flashing tape. Cut one piece of flashing tape to extend 1" past both side flashing tapes.

*Note: Steps C-E are required for 4 panel doors with field assembled frames only.*

- C. Apply sealant at the point where the door frame cladding contacts the nailing fin across the top and at each end of the frame.

- D. Install a head drip flashing.

- E. Apply a piece of flashing tape over the head flashing as shown.

- F. Apply the top flashing paper. Cut a piece of flashing paper 21" longer than the width of the opening. Center it above the door and staple it to the header so the bottom edge is flush with the top of the door or flashing.

**NOTICE** Press all tape down firmly.

- G. Install interior sealant. Refer to the interior sealant instructions at the end of this booklet.

- H. Attach wood blocking to the exterior of the opening to support the edge of the door sill (doors with sill nail fins only).

- I. Install head flashing, properly incorporating it with the siding and building wrap according to applicable code requirements.

- J. Install exterior sealant. (After wall cladding is installed) Refer to the exterior sealant instructions at the end of this booklet.

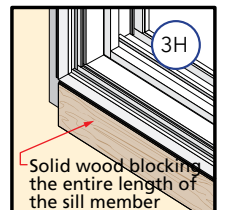
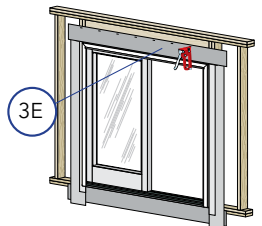
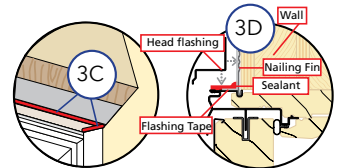
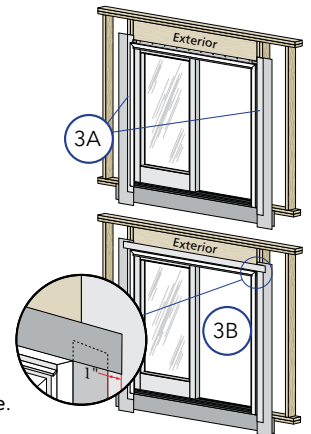



# ANCHOR INSTRUCTIONS – INSTALLATION METHODS FOR CLAD EXTERIOR PELLA® RESERVE AND PELLA® LIFESTYLE SERIES SLIDING PATIO DOORS (INCLUDING IMPACT-RESISTANT)

Pella® impact-resistant Products have been tested in accordance with the large missile impact testing requirements of ASTM E 1886 and ASTM E 1996. Pella impact-resistant Products are neither hurricane proof nor are they shatter proof. Severe wind and rain may produce temporary conditions which exceed product performance standards. When these units are subjected to intense storms or extreme conditions, which exceed the intended design pressures, air, water and flying debris infiltration may occur. Advanced performance and impact-resistant require the use of installation clips or screws through the frame. The use of fins or brickmould is optional and will not affect anchorage requirements. Local building codes may have additional anchoring requirements.

Units with Pella Enduraclad exterior trim with narrow fins and NO pre-punched holes must be anchored using frame screws or installation clips.

An "X" in the chart below indicates the fastener (row) to be used, under a specific installation method column. All fasteners marked with an "X" in an installation method column are necessary to meet documented performance values.

Fastener LETTER Alpha character	Installation Method			Opening Substrate Type		Illustration
	Nail Fin and Screws	Screws Through Frame	Clip & Screws	Wood	Masonry	
A	X*			2" 11 Ga. Roof Nail		I, II, IV
B	X*	X	X	#8 x 2-1/2"	3/16" x 2-1/2" Masonry Screw	VI, VII
C		X		#10 x 3-1/2"	1/4" x 3-1/2" Masonry Screw	v
D	X*	X	X	#8 x 3"	3/16" x 3" Masonry Screw	i, ii, VII
e			X	#6 x 1-1/4" **	3/16" x 1-1/4" Masonry Screw	III, v

\* Impact-resistant products **must** be installed with either Screw Through Frame or Clip and Screw method, but may also have nail fins.

\*\* For light gauge steel framing, use #10 self-tapping screws.

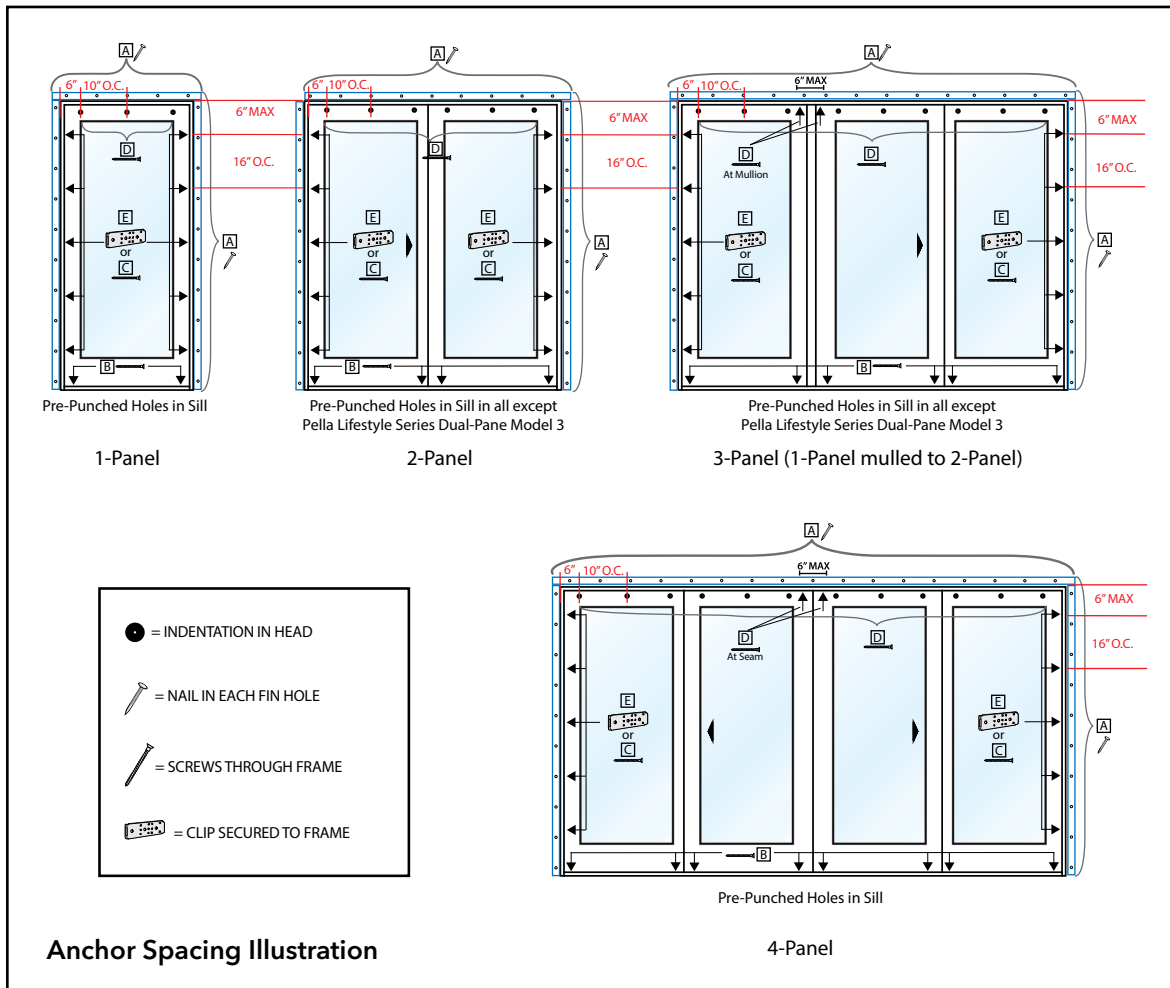



# ANCHOR INSTRUCTIONS – INSTALLATION METHODS FOR CLAD EXTERIOR PELLA® RESERVE AND PELLA® LIFESTYLE SERIES SLIDING PATIO DOORS (INCLUDING IMPACT-RESISTANT)

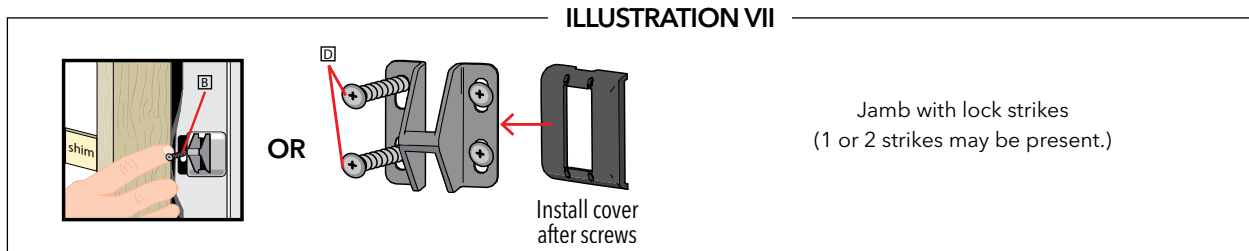
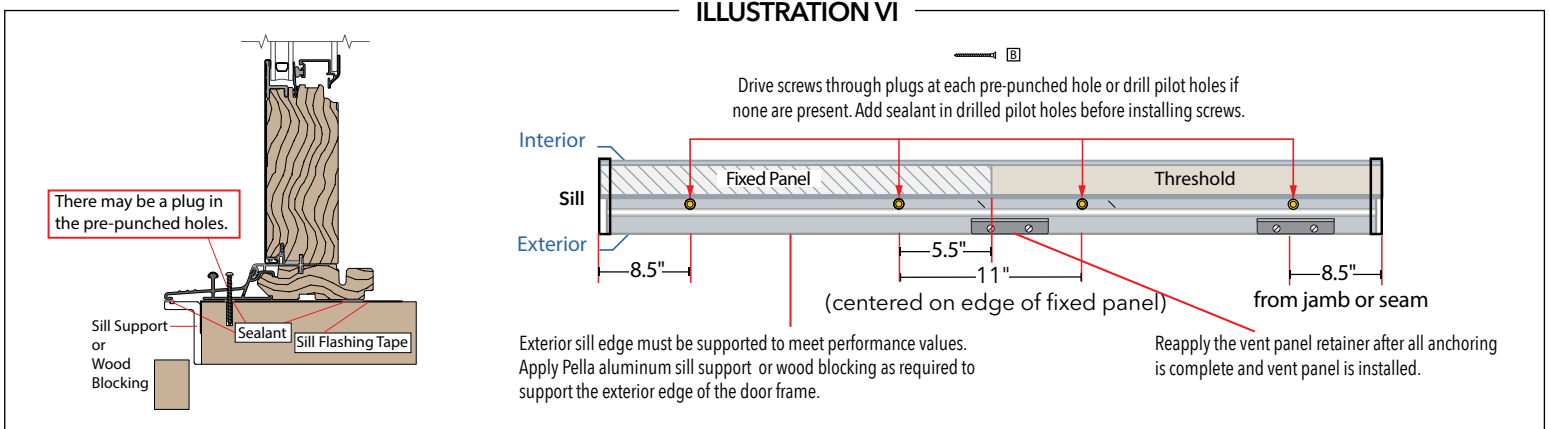
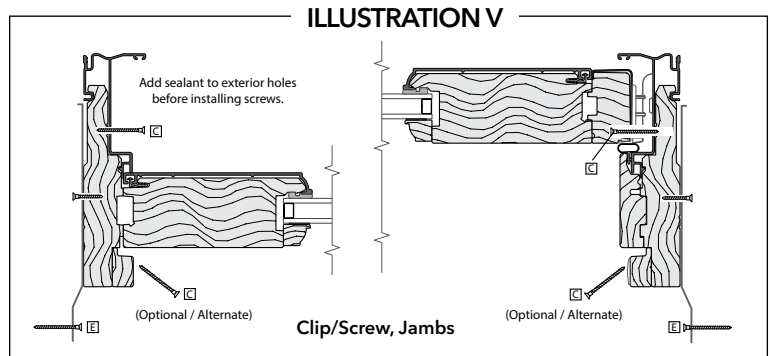
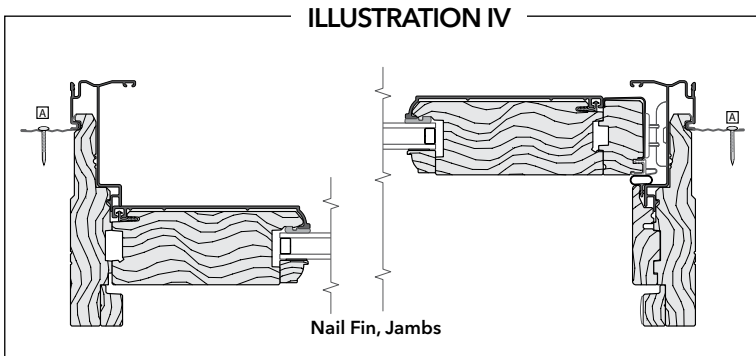
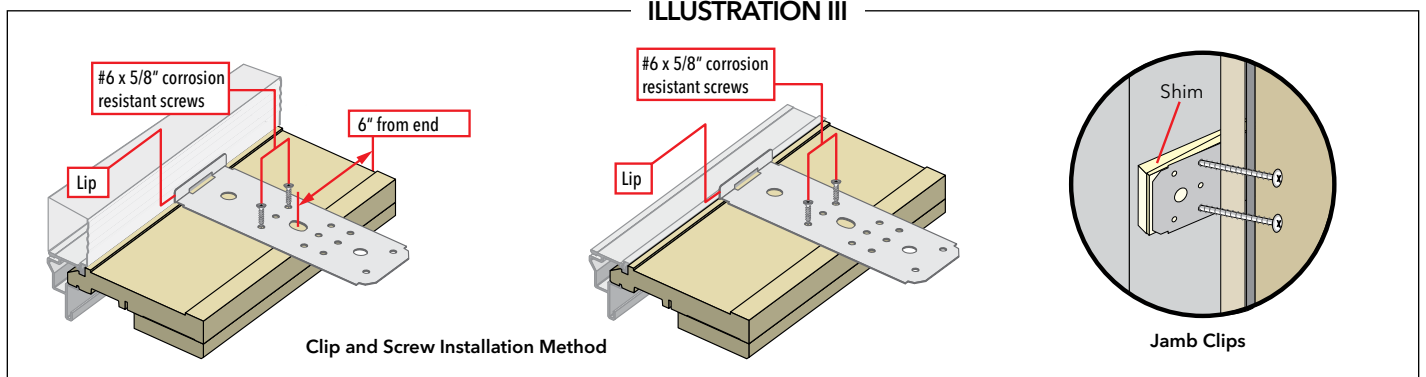
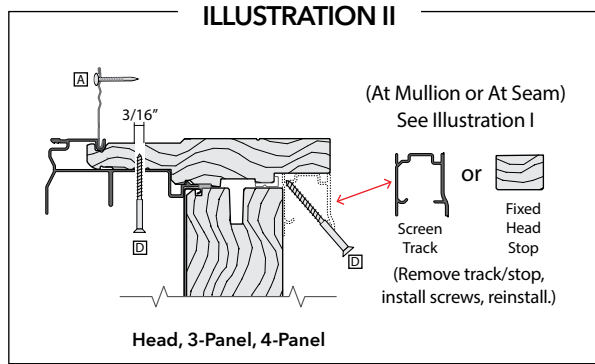
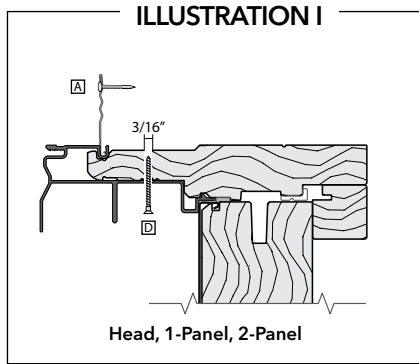



# ANCHOR INSTRUCTIONS - NAIL FIN FRAME INSTALLATION METHODS FOR PELLA® 250 SERIES, ENCOMPASS BY PELLA® AND PELLA® 150 SERIES SLIDING PATIO DOORS

**NOTE:** Standard performance only. Additional anchoring may be required for performance upgrade, impact-resistant products or to comply with local building code requirements.

Product	Location		Anchor Type		Instructions	Illustration
			Wood	Masonry		
Encompass by Pella, Pella® 150 Series	Head / Jamb / Sill Nail Fin		2", 11 Ga. Roofing Nail	N/A	Drive nails in every pre-punched hole	A
	Head and Sill - Interlockers only		2", 11 Ga. Roofing Nail	N/A	Place additional anchors, spaced 2" apart, through the nail fin	B
	Jamb	Strike / Lock / Keeper	#10 x 2" Corrosion Resistant (provided)	1/4" x 3-1/2" Masonry Screw	Refer to installing the keeper instructions on page NFSD-20 and illustrations below	C
	Sill	Frame Screws - Nail fin removed	#10 x 2" Corrosion Resistant (provided)	1/4" x 2" Masonry Screw	Pre-drill and apply sealant then drive screws 4" from corners and 19" on center max spacing.	A, D
Pella 250 Series	Head / Jamb / Sill Nail Fin		2", 11 Ga. Roofing Nail	N/A	Drive nails in every pre-punched hole	A
	Head / Jamb / Sill Frame Screws		#10 x 2" Corrosion Resistant (provided)	3/16" x 1-1/2" Masonry Screw	Drive screws at each pre-drilled installation hole at interlockers. Pre-drill and drive screws on each side of mullions. Refer to the illustrations for location and spacing. Apply sealant prior to driving screws through the sill.*	A, B, C
	Jamb	Strike / Lock	#8 x 2" (provided)	N/A	OX / XO / OOX / XOO: Drive screws at each hole in the lock strike (4 total).	C
	Astragal	Strike / Lock	#8 x 3/4" (provided)	N/A	OXO / OXOO: Drive screws at each hole in the lock strike (4 total).	C
	Sill	Frame Screws - Nail fin removed	#10 x 2" Corrosion Resistant (provided)	1/4" x 2" Masonry Screw	Pre-drill and apply sealant then drive screws 4" from corners and 19" on center max spacing.	A, D

\* 250 Series High Performance Only-Drive additional frame screws in pre-drilled holes in the head, jamb, and sill.

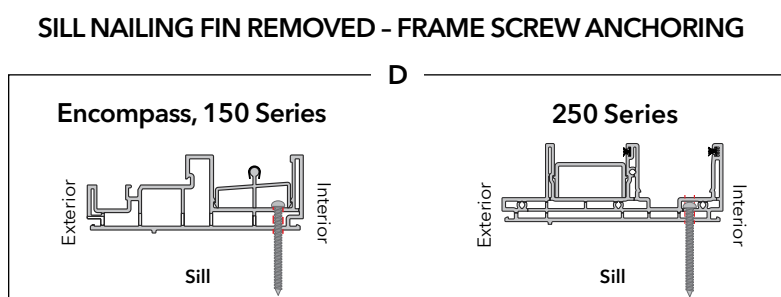
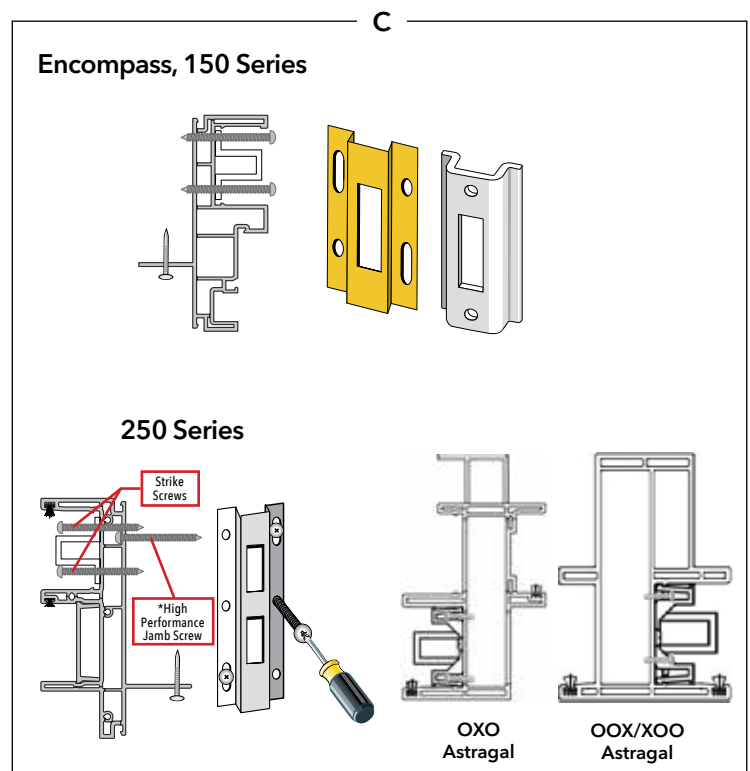
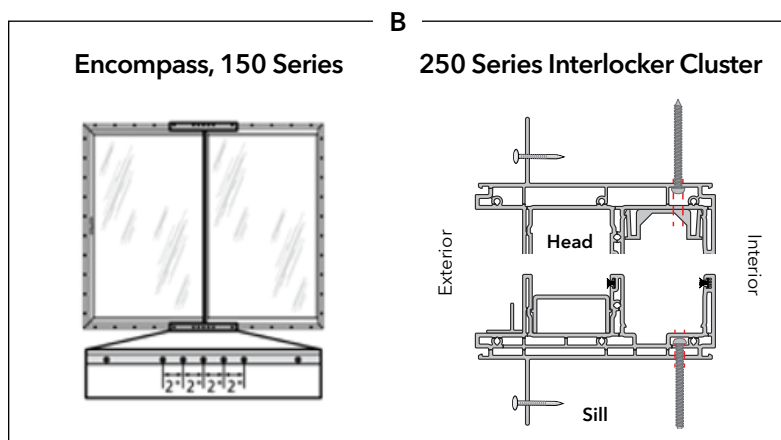
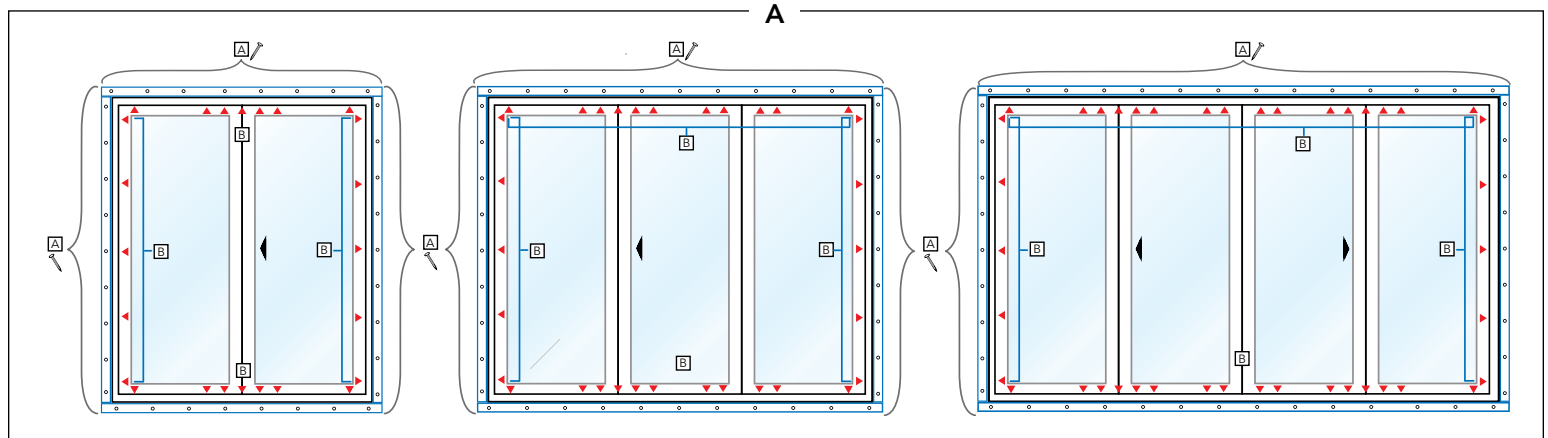



# ANCHOR INSTRUCTIONS - NAIL FIN INSTALLATION METHODS FOR PELLA® IMPERVIA SLIDING PATIO DOORS (INCLUDING IMPACT-RESISTANT)

**NOTE:** Standard performance only. Additional anchoring may be required for performance upgrade or to comply with local building code requirements.

Location		Anchor Type		Instructions	Illustration
		Wood	Masonry		
Head/ Jamb	Nail Fin*	2", 11 Ga. Roofing Nail	N/A	Within 3.5" from each corner and 7" on center (every other pre-punched hole). <b>All PG 35 and PG 50 up to 71.25" x 81.50" frame size.</b>	A
	Nail Fin with Frame Screws	#10 x 3" (provided)	3/16" x 1-3/4" Masonry Screw	Use factory-drilled installation holes if present. Drill holes through both walls and into the rough opening using a 1/8" bit then drill a 3/8" hole through the first wall only. <b>Required to meet PG 50 if &gt;71.25" x frame width or &gt;81.50" frame height.</b>	
	Frame Screws	#10 x 3" (provided)	3/16" x 1-3/4" Masonry Screw		
	Installation Clips	#8 x 1 1/4"	3/16" x 1 1/2"	Slide clips into slot from frame ends. Adhere clip with tape. Not applicable with nail fin	
Sill	Frame Screws	#8 x 3" (provided)	3/16" x 2 1/2" Masonry Screw	Remove inner sill cover. Use factory-drilled installation holes, pilot with 1/8" bit into rough opening. Apply sealant in each hole before driving screws.	C
	Vent Panel Retainer Support	#8 x 3" (provided)	3/16" x 2 1/2" Masonry Screw	Apply sealant in each hole before driving screws. Reinstall sill cover.	
	Fixed Panel Structural Bracket	#10 x 3" (provided)	3/16" x 2 1/2" Masonry Screw	Remove one factory-installed screw first. Pre-drill 3/16". Pilot with 1/8" bit into rough opening. Apply sealant in each hole before driving screws.	
	Aluminum Support	#8 x 3/4" (provided)	NA	Available separately - consult your local Pella representative.	
Mullions*		#10 x 3"	3/16" x 1-3/4" Masonry Screw	<b>Head:</b> Drill holes through both walls and into the rough opening using a 1/8" bit then drill a 3/8" hole through the first wall only. Add sealant prior to driving screws at the sill.	B
Lock Strike		#8 x 3"	3/16" x 1-3/4" Masonry Screw	<b>Grade 40 Security:</b> Install (4) installation screws per strike. <b>Grade 10 Security:</b> Install (2) installation screws (diagonally) per strike. Pilot all installation screw locations with 1/8" bit into rough opening.	D

\*For light gauge steel framing, use #10 self-tapping screws.  
\*\*Anchor through structural mullion end anchors, if present.

\*\*\*Impact-Resistant products must be installed with frame screws. Fin fastening (if applicable) is optional for flashing purposes. Refer to Florida Product Approval documents (if applicable).

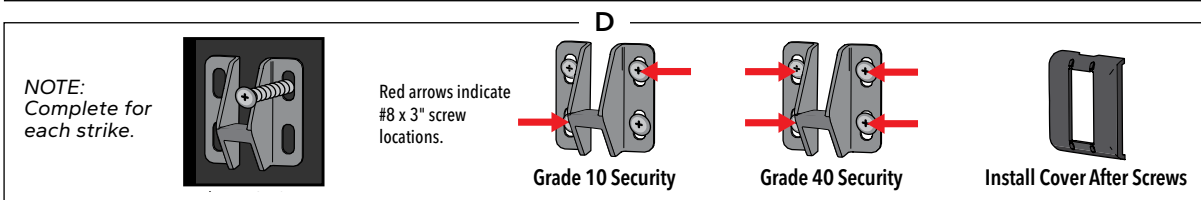
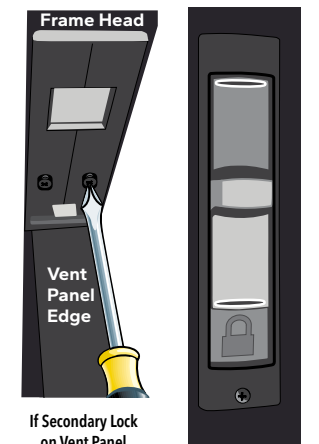
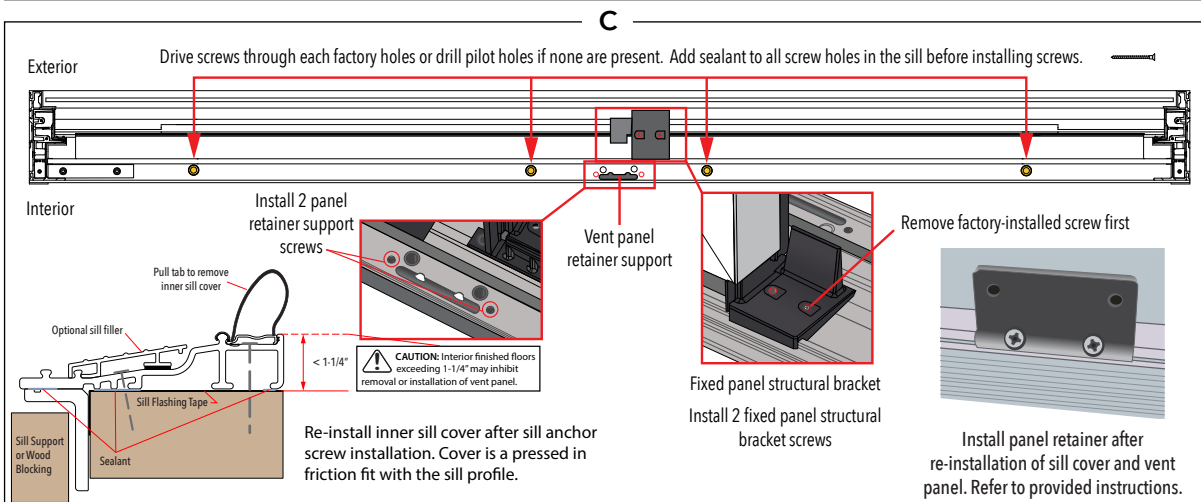
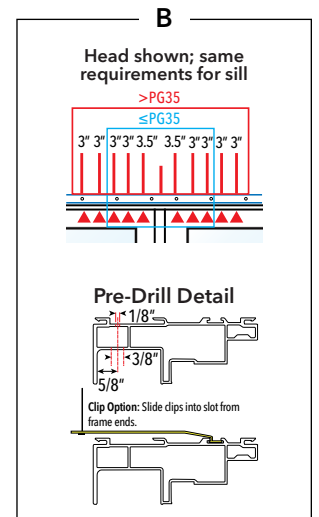
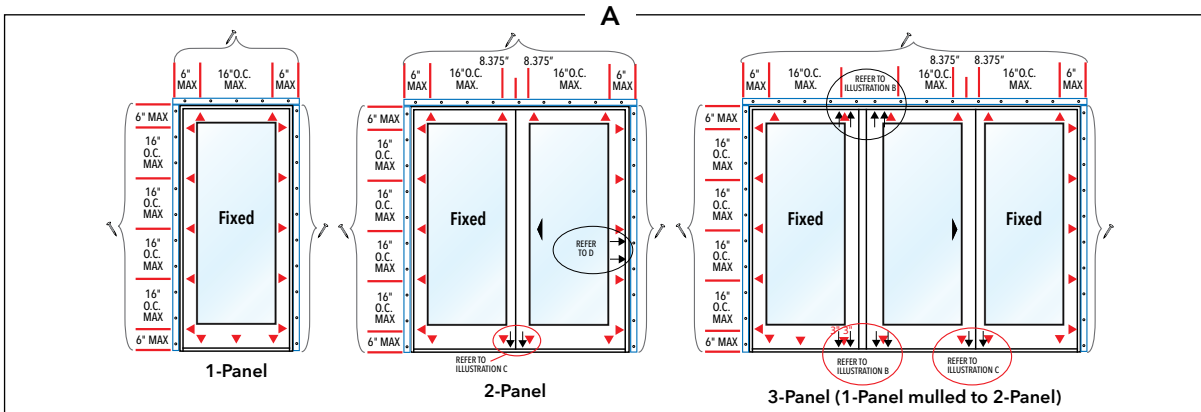





# INSTALLING THE KEEPER FOR PELLA® 250 SERIES, PELLA® ENCOMPASS BY PELLA® AND PELLA® 150 SERIES SLIDING PATIO DOORS; REVERSING DOOR SLIDE FOR ENCOMPASS BY PELLA® AND PELLA® 150 SERIES SLIDING PATIO DOORS

## KEEPER INSTALLATION FOR ENCOMPASS BY PELLA® AND PELLA® 150 SERIES:

- D. **Identify the keeper** in the hardware package and perform the keeper attachment steps based on which keeper is in the package. Determine the keeper location by opening the panel a few inches and extending the lock hook. With a pencil, mark the location on the jamb directly across from the top of the shank.
- E. **Place the keeper with 4 screw holes** on the jamb so the top of the slot is aligned with the pencil mark. Attach by inserting a #6 x 1/2" starter screw into one of the slotted keeper holes.
- F. **Place the keeper with 2 screw holes** on the jamb by "snapping" it into the frame jamb at the desired location. The keeper may be moved up or down to align with the pencil mark. The keeper will stay in position until attached with screws.
- G. **Insert a shim** between the frame jamb and the rough opening at the keeper location.
- H. **Adjust the lock hook** by turning the door lock adjustment screw clockwise to loosen or counter-clockwise to tighten until the mortise lock is aligned properly, the door locks easily, and there is less than 1/16" movement when the door is locked.
- I. **Install the keeper** by inserting 3" long screws (provided) through the keeper holes, the shim and into the rough opening frame members. Remove the starter screw from the 4 screw hole keeper and replace it with a 3" long screw.

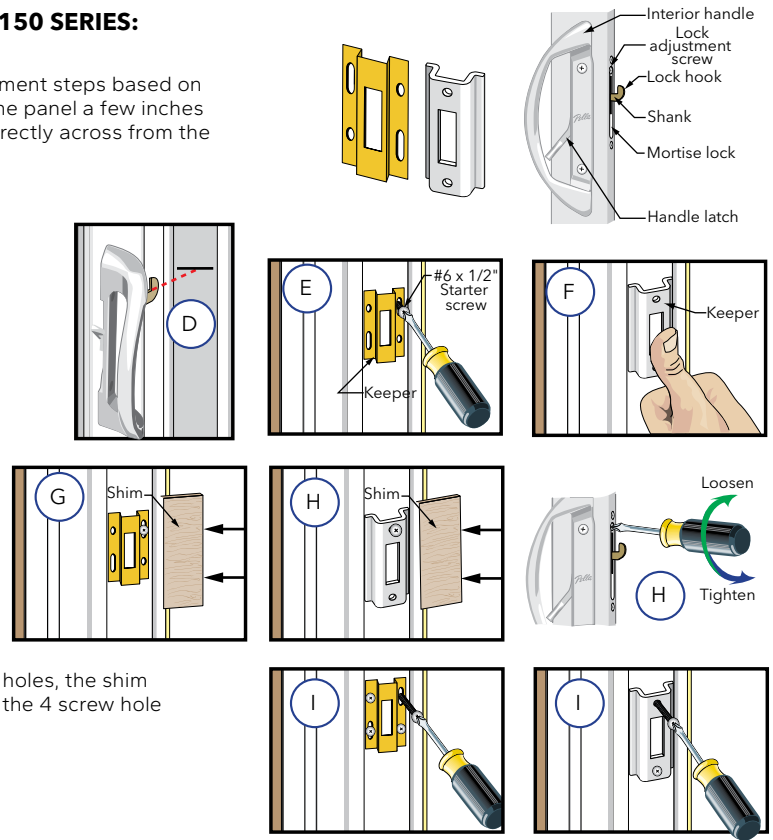

Note: Doors with Blinds-Between-the-Glass are not reversible.

## REVERSING DOOR SLIDE FOR ENCOMPASS BY PELLA® AND PELLA® 150 SERIES:

- A. **Remove the sill and screen tracks** from the door. (Use an Allen wrench or small hook to begin removal.)
- B. **Rotate the main frame 180°** (so the sill becomes the head). Snap the sill and screen tracks into place at the bottom of the door. Carefully lay the panel on saw horses or a clean surface.
- C. **Extend the lock hook** and clamp the lock hook with the vise grip.
- Note: Use of the vise grip on the lock hook will prevent the mortise lock from falling when the lock mounting screws are removed.
- D. **Remove the door handle** by removing the two attachment screws.
- E. **Remove the mortise lock**. Remove the two screws that attach the lock assembly to the door panel. Work the lock

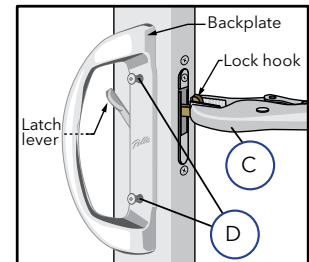

- down, then tilt it out and pull up.
- F. **Rotate 180° and reinstall the lock**. Insert the mortise lock into the door panel with the lock adjusting screw positioned at the bottom, then tilt the top in and lift the lock into position. Insert the two mounting screws into the lock mounting holes.
- G. **Rotate the handle 180°** and install the door handle by inserting the two backplate screws through the door panel and into the exterior handle.
- Note: Rotating the handle will result in "Pella" script being upside down. A new handle must be ordered for "Pella" to be in correct orientation.
- Note: The latch lever must engage the slot in the side of the mortise lock assembly.

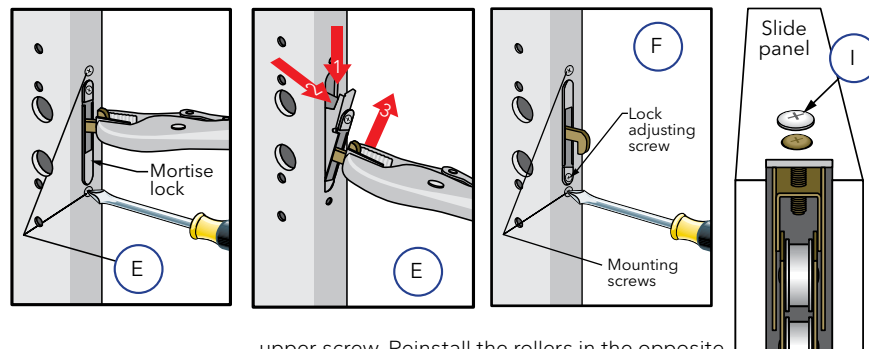

- H. **Remove the bottom rollers** from the slide panel by removing the upper screw. Reinstall the rollers in the opposite
- I. **High Performance Doors only:** Remove the blocks from the top rail of the door panel and reinstall them at the opposite end of the panel.
- J. **High Performance Doors only:** Move the frame exterior vent plugs (white foam rods) from the head of the frame to the opposite side of the frame. A soap solution may be needed as a lubricant for re-installing the plugs.



### Interior Sealant Instructions

**NOTICE** Continuous backer rod (as necessary) and a high quality, low-odor interior sealant such as Pella Window and Door Installation Sealant (or equivalent) is recommended for commercial or high performance installations to create the continuous interior seal. Follow the directions on the cartridge. For standard performance or products with factory applied jamb extensions, use low pressure polyurethane insulating foams. Follow the directions on the can. Do not use high pressure or latex foams. Fiberglass batt or similar insulation is not recommended as it can absorb water and does not act as an air seal.

- A. Insert the nozzle or straw between the rough opening and door frame from the interior. Use a pliers (if necessary) to compress the end of a straw tube to allow it to fit in tight openings.
- B. Place a 1" deep bead of foam approximately 1" from the interior of the frame to allow for expansion. DO NOT fill the entire depth of the rough opening cavity.

**NOTICE** DO NOT fill the entire depth of the rough opening cavity. Leave exterior one-third (1/3) of cavity open. Apply foam between the frame and rough opening flashing materials, NOT between jamb extensions and the rough opening.

- C. Re-Check door operation and remove remaining shipping spacers after foam installation. Excess foam may be removed with a serrated knife after it cures.
- D. To ensure a continuous interior seal, apply sealant over or around any shims or clips interrupting the foam seal.
- E. Place a continuous bead of sealant across the inner sill at the intersection of the door sill and subfloor. Continue the sealant 6" up each jamb and connect with the foam seal..

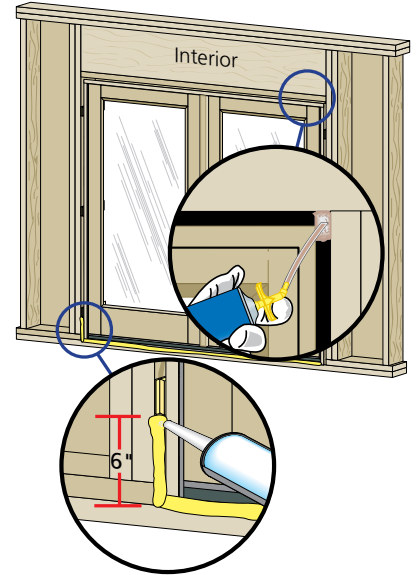

### Exterior Sealant Instructions

**NOTICE** Use a high quality, multi-purpose exterior sealant such as Pella Window and Door Installation Sealant. Follow the directions on the cartridge.

When applying siding, brick veneer, flashing, or other exterior finish materials, leave adequate space between the door frame and the material for sealant application of sealant.

- A. Insert backer rod 3/8" deep in the space around the door. Backer rod adds shape and controls the depth of the sealant line.
- B. Apply a continuous bead of sealant to the entire perimeter of the door.

**NOTICE** For sill pans designed to drain moisture directly to the exterior, voids in the exterior seal may be required.

- C. Shape, tool and clean excess sealant. When finished, the sealant should be the shape of an hourglass.

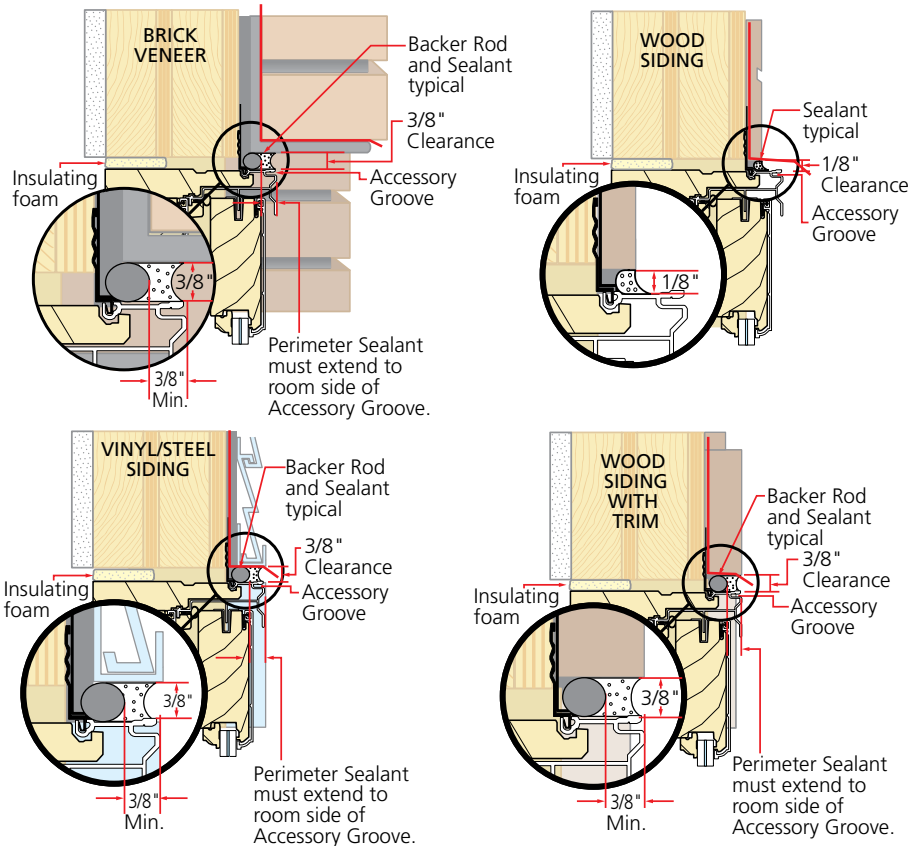
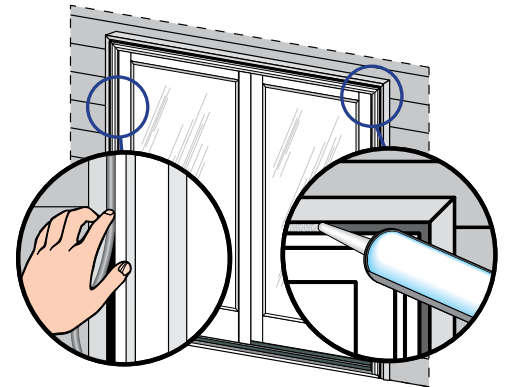



## OPTIONAL SILL PAN INSTRUCTIONS

**NOTICE** The method of pan construction, flashing, and sealant application may vary depending on the design of the opening sill and exterior landing surface conditions. It is important to consider the exposure to weather, the exterior landing surface's proximity to the door sill, and to confirm impervious exterior surfaces properly slope away from the door.

A. **Cut the sill pan** to the width of the rough opening plus 2".  
*Note: The 2" added onto the rough opening width is for a 1" bend on each end.*

B. **Make a 1" cut** in each fold at both end of the sill pan.  
*Note: These cuts will allow the edges of the sill pan to be bent.*

C. **Cut 1" off each end** of the interior sill pan lip.

D. **Bend each end** of the center panel up.

E. **Install the sill pan** by sliding into place until the exterior sill pan lip is flush with the exterior of the rough opening.

F. **Apply sill flashing tape.** Cut a piece of flashing tape 2" longer than the opening width. Apply at the bottom of the opening, covering the exterior sill pan lip as shown.

*Note: If applicable, apply spray adhesive to building felt prior to applying the flashing tape.*

G. **Cut a piece of flashing tape** to the width of the opening. Install tape to the sill pan and overlap the flashing tape from step 1F by 1". If needed add a second or third piece of flashing tape until the sill pan is covered to the interior sill pan lip.

*Note: The purpose of this tape is to seal the sill screws when installing the door.*

H. **Cut two 9" pieces of flashing tape** with a 1" x 3" tab at the bottom, on opposite corners as shown.

I. **Apply the tabbed 9" pieces of flashing tape.** The tape is applied so 2" will cover the inside of the rough opening and lap over the side flange of the sill pan. The 1" x 3" tab laps over the bottom flashing tape as shown.

J. **Cut two 6" pieces of flashing tape** and apply to each side of the rough opening, overlapping the first piece by 1" and lapping the bottom over the side flange of the sill pan as shown.

K. **Cut two pieces of flashing tape 1-1/2" x 6"** and apply to the bottom corners of the opening by beginning in the corner of the sill pan, with 3/4" of the tape applied to the sill pan and 3/4" of the tape applied to the side flange. The remainder of the tape is to be at a 45 degree angle onto the exterior.

L. **Attach the aluminum sill support** or wood blocking to the exterior of the box plate to support the edge of the door sill. Place the sill support flush with the subfloor.

## Concrete Slab (without sill pan) Instructions

*Note: Thoroughly clean the slab where sealants will be installed. Instead of installing flashing tape across the bottom of the rough opening, complete the following:*

- A. **Install flashing tape** at the bottom 6" of the rough opening jambs.
- B. **Cut (2) 9" pieces of flashing tape** as shown in step 1H above.
- C. **Install them overlapping** the flashing tape installed in step A by 1".
- D. **Place a 3/8" bead of sealant** where the bottom edge of the flashing tape meet the concrete slab.
- E. **When folding building wrap in at the jambs**, cut at a 30 degree angle as illustrated.

*Follow the applicable installation method pages to complete the installation except seal the door sill directly to the slab.*

