

# IMPORTANT SAFETY AND PRODUCT INFORMATION – DOORS

Safety Alert Symbol Reference: *These symbols are intended to alert you to potential injury hazards and information. Obey all safety messages.*

**COULD**  
Result in:



**COULD**  
Result in:



**COULD**  
Result in:



**COULD**  
Result in:



To ensure safety and security and help prevent property damage, including possible damage to your window or door, close and lock windows and doors any time they are not being used for venting on a nice day, and particularly during high winds or rain. Ensure all windows and doors are properly fastened to the wall structure according to the product anchor instructions. It is the responsibility of the Buyer or User, the architect, contractor, installer, or other construction professional to ensure the appropriate windows and doors are chosen for the project and the wall construction is designed to resist all loads in accordance with local building code requirements.



Many doors in older homes are painted with lead-based paint. Removal of old doors may disturb this paint. Proper precautions must be taken to minimize exposure to dust and debris. Consult state or local authorities and/or go to [www.epa.gov/lead](http://www.epa.gov/lead) for more information.



Pella products must be stored in an upright, level position not exposed to weather. The storage must be ventilated and provide protection from direct sunlight and excessive temperature.



Because all construction must anticipate some water infiltration, it is important that the wall system be designed and constructed to properly manage moisture. Pella Corporation is not responsible for claims or damages caused by anticipated and unanticipated water infiltration; deficiencies in building design, construction and maintenance; failure to install Pella products in accordance with Pella's installation instructions; or the use of Pella products in wall systems which do not allow for proper management of moisture within the wall systems. The determination of the suitability of all building components, including the use of Pella products, as well as the design and installation of flashing and sealing systems are the responsibility of the Buyer or User, the architect, contractor, installer, or other construction professional and are not the responsibility of Pella.

Pella products should not be used in barrier wall systems which do not allow for proper management of moisture within the wall systems, such as barrier Exterior Insulation and Finish Systems (EIFS) (also known as synthetic stucco) or other non-water managed systems. Except in the states of California, New Mexico, Arizona, Nevada, Utah and Colorado, Pella makes no warranty of any kind on and assumes no responsibility for Pella windows and doors installed in barrier wall systems. In the states listed above, the installation of Pella Products in barrier wall or similar systems must be in accordance with Pella's installation instructions. Product modifications that are not approved by Pella Corporation will void the warranty.

**CARE AND MAINTENANCE:** Refer to the Pella Owner's Manual. Visit [www.pella.com](http://www.pella.com) or your local retailer for more information.

**CLEANING INSTRUCTIONS:** Refer to the Pella Owner's Manual for comprehensive maintenance and cleaning information. Visit [www.pella.com](http://www.pella.com) or your local retailer for more information.



DO NOT apply any other types of film to the glass. Doing so could void product warranty.



DO NOT use abrasives. DO NOT scrape or use tools that might damage the surface.



DO NOT use inappropriate solvents or brickwash or cleaning chemicals. If you do, permanent damage can result and the product failure, loss or damage would not be covered by the Limited Warranty.

**FINISHING INSTRUCTIONS (WOOD PATIO DOORS):** Paint or finish immediately after installation.

If products cannot be finished immediately, cover with clear plastic to protect from dirt, damage and moisture. Remove any construction residue before finishing. Sand all wood surfaces lightly with 180 grit or finer sandpaper. DO NOT use steel wool. BE CAREFUL NOT TO SCRATCH THE GLASS. Remove sanding dust. Pella products must be finished according to these instructions; failure to follow these instructions voids the Limited Warranty. Finishing panel edges is optional for Patio Doors.



To maintain proper product performance do not paint, finish or remove the weatherstripping, mohair dust pads, gaskets or vinyl parts. Air and water leakage will result if these parts are removed. After finishing, allow venting Doors and doors to dry completely before closing them. If paint, stain or finish gets on the weatherstripping, wipe it off immediately with a damp cloth.

**PANEL CLEANING AND PREP INSTRUCTIONS FOR UNFINISHED OR PRIMED PANELS:** Dry wipe dust from doors gently. Examine door for possible smudges or fingerprints made from normal handling or construction. To remove smudges, lightly wipe surface with warm water. Let door and sidelight surfaces dry completely before applying finish. Finish the door panels as soon as possible after installation.

**UNFINISHED INTERIOR FRAME MEMBERS:** Unprimed interior frame parts may be stained with wood stains and should be finished with a minimum of two coats of a clear polyurethane finish.

**PAINTING INSTRUCTIONS:** Wood door frame exteriors are factory primed. Wood doors require painting immediately after installation. The factory applied primer is not intended for long term exterior exposure. Sand all un-primed interior wood surfaces lightly with 180 grit or finer sandpaper before priming and painting. Use two coats of a 100% latex paint that has a good blocking resistance. Finishing panel edges is optional for Patio Doors.

Pella Corporation is not responsible for interior paint and stain finish imperfections for any product that is not factory-applied by Pella Corporation. For additional information on finishing see the Pella Owner's Manual or go to [www.pella.com](http://www.pella.com).









The use of unapproved finishes, solvents or cleaning chemicals may cause adverse reactions with door materials. Pella will not be responsible for problems caused by the use of unapproved materials. If in doubt, contact your local retailer or representative.

**EXTERIOR FINISH OF EXISTING FRAME (POCKET REPLACEMENT):** It is the responsibility of the homeowner, contractor or installer to ensure any exposed unfinished wood is covered or finished. Possible methods include, however are not limited to, covering with aluminum coil stock or painting.



# PREPARING FOR SLIDING DOOR INSTALLATION WITH NAIL FIN

## You will need to supply:

- Moisture resistant shims/spacers (12 to 20) 
- Fasteners (see anchor instructions and tables at the end of this booklet) 
- Closed cell foam backer rod/sealant backer (21 to 30 ft.) 
- Pella® SmartFlash™ foil backed butyl window and door flashing tape or equivalent 
- Pella Window and Door Installation Sealant or equivalent high quality, multi-purpose sealant. 
- Low Expansion, low pressure polyurethane insulating window and door foam sealant. DO NOT use high pressure or latex foams 
- Sill pan (optional) 6-5/8" x (Rough Opening Width +2)
- Pella aluminum sill support or wood blocking
- Interior trim and/or jamb extensions (15 to 40 ft.)

## Installation Clip Option (Reserve, Lifestyle, and Impervia only):

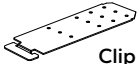
- 6" installation clips (710L) 
- #8 x 1-1/2" corrosion resistant screws or 3/16" x 1-1/2" masonry screws

Clip 710L

## Tools required:

- Tape measure 
- Level 
- Square 
- Hammer 
- Stapler 
- Sealant Gun 
- Scissors or utility knife 
- Tin Snips 
- Screwdrivers (#2 Phillips with 8" shaft and small flat blade) 
- Drill 
- 5/32", 1/8", and 3/8" drill bits and masonry bit(s) for concrete applications
- Fine tooth chop saw 
- Large hook tool 

**WARNING** Installation will require (2) or more persons for safety reasons.

## ROUGH OPENING VERIFICATION

A. Confirm the opening is plumb and level.

**NOTICE** It is critical the bottom is level and it does not slope to the interior or exterior.

B. Remove dirt, oil or debris from the opening and surrounding wall surfaces.

C. Confirm the door will fit the opening. Measure all four sides of the opening to make sure it is 1/2" to 3/4" larger than the door in both width and 1/2" larger in height. Measure the width and height in several places to ensure the header or studs are not bowed. Confirm the opening header is not sagging. The header must be designed to bear the weight of all building/structure loads.

**NOTICE** 1-1/2" or more of solid wood blocking is required around the perimeter of the opening. Fix any problems with the rough opening before proceeding.

**NOTICE** It is important to consider the door's exposure to weather, the exterior landing surface type and its proximity to the door sill, and to confirm impervious exterior surfaces properly slope away from the door prior to continuing with installation.

Before installing, verify performance of the product meets the requirements of the application and region. To reduce the likelihood of water infiltration where application exceeds product performance, install doors under an overhang the extends to meet a 45 degree line from the door sill and slope the exterior 2 degrees away from the door or use a stepdown. Failure to do so may result in damage to the interior of the structure.

**NOTICE** FAILURE TO PROVIDE ADEQUATE ROUGH OPENING SILL PROTECTION FOR WOOD THRESHOLDS WILL VOID PRODUCT WARRANTY.

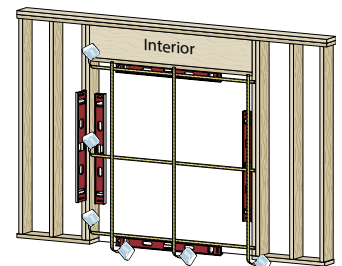

## PREPARE THE DOOR FOR INSTALLATION

A. Remove plastic wrap and cardboard packaging from the door. For Pella® 250 Series doors with laminate film, remove protective film from all parts.

B. Inspect the product for any damage such as cracks, dents or scratches. DO NOT install damaged products.

C. For Knock-Down (KD) Doors: Complete field assembly of the frame in accordance with the KD assembly instructions.

D. All Doors: Remove the vent panel prior to installation (if applicable). Slide the vent panel about halfway open. Lift the panel up and tilt the bottom of the panel away from the door frame. Then lower the panel out of the top track. Carefully set the panel aside.

**Pella® Reserve and Lifestyle Series Sliding Doors:** Remove the shipping spacers off the top and bottom of the vent panel.

**Pella® Impervia:** Remove the shipping spacers from the bottom of the vent panel.

**Pella® 250 Series:** Remove the jamb pocket covers/caps and head cover/cap. For laminate units, remove the laminate protective film. Pre-drill anchor holes.

**Pella® 150 Series and Encompass by Pella®:** If reversing the door slide direction, refer to the instructions later in this booklet.

E. Fold out installation fin to 90° (if applicable). Be careful not to remove or tear the fin corners.

Note: if the fin is not at 90, the door will not line up correctly on the interior.

F. Pella Reserve and Lifestyle Series doors (with wide EnduraClad Exterior Trim) and all 250 Series doors with narrow 1" fins and NO pre-punched holes: Fin is for flashing purposes only. Install clips or pre-drill holes for frame screws. Additional preparation may be required for Performance Upgrade or to comply with local building code requirements. Refer to the product anchor pages at the end of this booklet.

G. Read the entire instruction before proceeding.

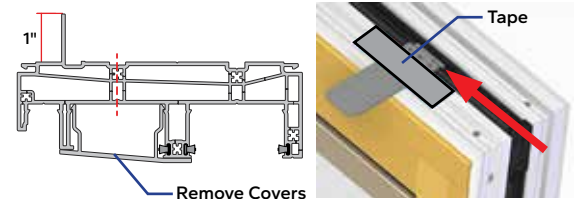

These instructions were developed and tested for use with wall systems designed to manage water. These instructions are not to be used with any other construction methods or door frame types. Installation instructions for use with other construction methods or frame types may be obtained from Pella® Corporation, your local Pella retailer or [www.installpella.com](http://www.installpella.com). Building designs, construction methods, building materials, and site conditions unique to your project may require an installation method different from these instructions and/or additional care. Determining the appropriate installation method is the responsibility of you, your architect, or construction professional.



BY PURCHASING, INSTALLING OR USING PELLA PRODUCTS (INCLUDES PELLA GOODS AND PELLA SERVICES), YOU AGREED TO THE TERMS OF THE LIMITED WARRANTY AND YOU AND PELLA FURTHER AGREE TO ARBITRATE DISPUTES ARISING OUT OF OR RELATING TO PELLA PRODUCTS, AND YOU WAIVE ANY RIGHT TO PARTICIPATE IN A CLASS ACTION RELATED TO PELLA PRODUCTS unless you notify Pella of your decision to opt out of the Arbitration Agreement no later than ninety (90) calendar days from the date you purchased or otherwise took ownership of Your Pella Goods. Opting out of the Arbitration Agreement will not affect the coverage provided by any applicable limited warranty pertaining to Your Pella Products. For opt out information and additional details please read the Limited Warranty and Arbitration Agreement for your Pella Products at [www.Pella.com/arbitration](http://www.Pella.com/arbitration).

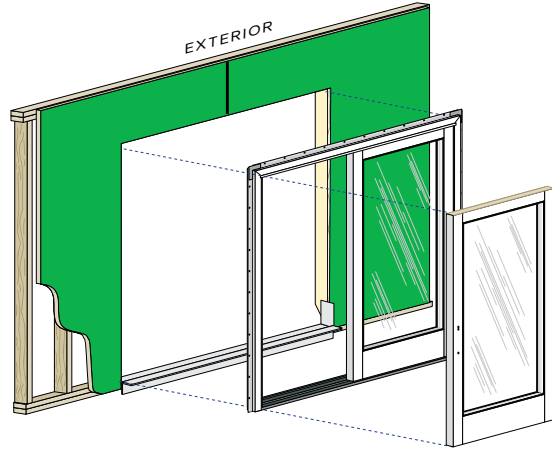
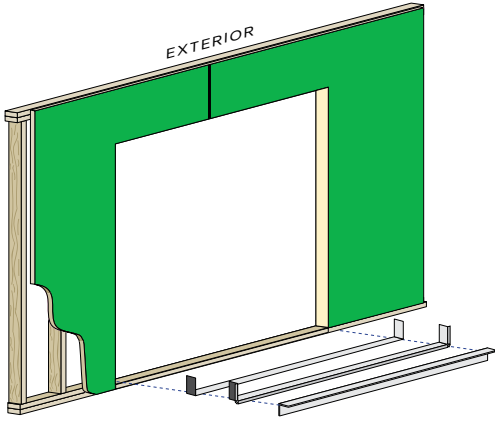

## 1 PREPARE THE OPENING

Refer to the nail fin installation preparation section at the beginning of this booklet.

- A. **Inspect the joints of the water resistant sheathing.** Joints must be sealed according to the sheathing manufacturer's instructions. *Pella Corporation assumes no responsibility for the design, quality or durability of the sheathing system or its joints. Taped joints intersecting with the bottom or sides of the opening must have tape installed before beginning installation.*  
**If using an optional sill pan or if the door will be installed on a concrete slab, refer to the instruction page at the end of this book.**
- B. **Cut 2 pieces of flashing tape 12" longer than opening width.**
- C. **Apply sill flashing tape #1** at the sill extending 2" to the exterior and 6" up each jamb.
- D. **Cut 1" wide tabs** at each corner by tearing the foil 1/2" each way from corner.
- E. **Apply sill flashing tape #2** overlapping tape #1 by 1" minimum. For In-Swing Doors with frame depth greater than 5", add a third piece of flashing tape so it comes within 1/4" of the interior of the door frame.

**NOTICE** Press all tape down firmly.

- F. **Cut 2 pieces of flashing tape.** Make one equal to the height of each side of the opening.
- G. **Apply one piece on each jamb** starting 1" from the exterior of the framing, over the edge of the sheathing and into the opening.
- H. **Apply a second piece on each jamb** overlapping the first piece by 1".

**IMPORTANT** Use a roller to firmly press all flashing tape down until the texture of the sheathing can be seen through the tape.

*Note: For doors with sill nailing fins, skip to step 2A and install only the interior most bead of sealant.*

- I. **Attach a Pella aluminum sill support** or wood blocking flush with the opening sill to support the exterior edge of the door frame.

## 2 SET AND FASTEN THE DOOR

For Encompass / 150 doors without sill nail fins, skip to step B.

- A. **Place three 3/8" beads of sealant across the opening sill.** Place the interior-most bead 1/2" from where the interior of the door sill will remain after installation. Continue this bead up the sill pan lip, if applicable. Place a second bead beginning from the interior bead 1/2" from each side, out to the exterior of the framing and along the opening. Leave 2" voids 4" from the corner and at the center. Place a third bead where the exterior of the door sill will remain after installation.

Proceed to step 2F.

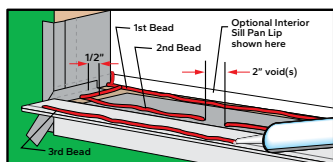
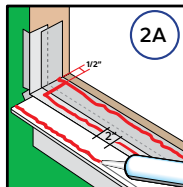
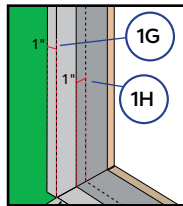
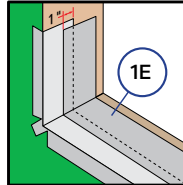
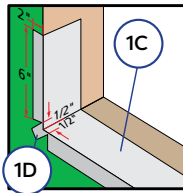

## 2 SET AND FASTEN THE DOOR

CONTINUED

Encompass / 150 Doors without sill nail fins use steps B-E, all others skip to 2F.

- B. **Remove the sill track** by beginning at one end and carefully pulling it up. This will expose the slide panel pocket.

*Note: A hooked tool like an Allen wrench will easily get the track started.*

- C. **Drill 3/16" holes through the sill every 18"**, starting from each corner and 1-3/16" from the interior. Counter-drill with a 3/8" bit through the first wall of the door frame only. Use a drill guide set 1/4" from the end of the bit to prevent drilling through the second wall.

- D. **Dry fit the door.** Make sure that the door is plumb, square and level. Mark and drill anchor locations. Mark the interior of the door frame at the sill to show a boundary for sealant placement. Carefully remove and set the door aside.

- E. **Apply 2 continuous 1/4" to 3/8" diameter beads of sealant** across the sill of the opening and 6" up the jambs, towards the interior side of the door (between the anchor holes and interior edge of door). **DO NOT** apply sealant between the anchor holes and the exterior side of the sill plate or floor.

**NOTICE** Failure to properly seal the door sill and any penetrations may allow water to penetrate the interior of the home.

- F. **Center the bottom of the door in the opening** and tilt the door into position. Do not slide the door into the opening. Sliding will damage the sealant lines. **Check the jambs for plumb** and confirm there is room for shimming between the jambs and opening on each side.

- G. **Walk across the sill** to compress the sealant and confirm the frame is firmly on the opening sill.

- H. **Drive two fasteners through the nail fin**, one near the sill on each side.

- I. **Plumb and square the door.** Place shims near the top corners, as necessary. Shims must be flat and support the frame to the exterior the full wall depth. On the interior, stop shims 1/2" short to allow for a continuous interior sealant, or seal across shims after trimming flush to the frame.

- J. **Drive two fasteners through the nail fin**, one near the top corner on each side.

- K. **Check the door placement** by measuring from the interior surface of the door frame or jamb extension to the interior surface of the wall for consistency. If the dimensions are not equal, confirm the fins are folded fully to 90° (if applicable).

*Note: For 250 Series and KD doors, insert fixed panel. Refer to KD assembly instructions (if applicable). Do not fasten 250 fixed panel until after vent panel is operational.*

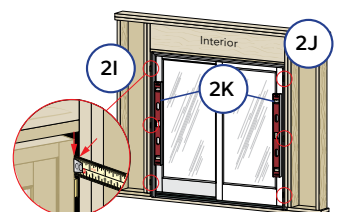
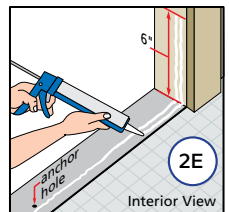
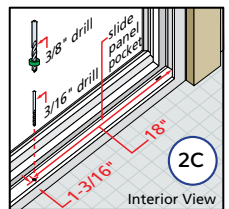



# NEW CONSTRUCTION INSTALLATION WITH NAIL FIN OVER WATER RESISTANT SHEATHING (CONTINUED)

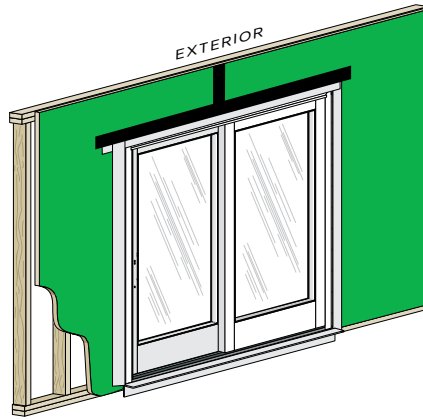
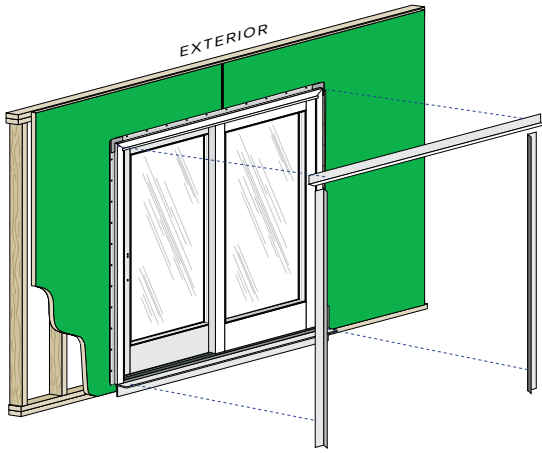

## 2 SET AND FASTEN THE DOOR CONTINUED

L. **Finish anchoring door.** Drive fasteners in nail fin and add screws through lock strikes and hardware (if applicable). Add additional screws through the frame and anchor installation clips as required.

**NOTICE** Shims are required at each screw location. Refer to the applicable anchor instruction page(s) near the end of this booklet.

M. **Install the sliding panel.** From the exterior, tilt the top of the panel and insert it into the top track. Move the bottom of the panel toward the door frame and set it on the bottom track. Be careful not to pinch your fingers between the two panels. DO NOT close the sliding panel until the hardware is installed. The door may lock when closed.

N. **Check door operation.**

**Reserve and Lifestyle Series Doors:** Adjust Vent Lock Tip (if applicable).

**Impervia Doors:** If Vent Lock does not lock, loosen screws and adjust strike plate locations and re-tighten screws.

**NOTICE** Adjust shims to correct any issues with plumb, square, operation or reveal.

O. **Adjust the panel height to 1/4" clearance** from bottom of panel to sill track by removing the hole cover (if applicable) and using a #2 Phillips screwdriver to turn the roller adjustment screw clockwise (raise) or counterclockwise (lower).

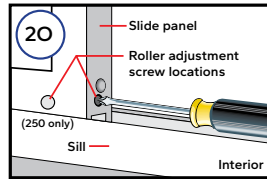

*Note: Reinstall the hole cover (if applicable) once adjustments are complete.*

**NOTICE** Check vent panel to frame and vent panel to fixed panel reveal.

**NOTICE** For doors with heavy laminate or triple pane glass use a small pry bar to raise the panel while turning the adjustment screw. This will prevent the threads from being stripped.

P. **Install the bumpers (if applicable).** Refer to the anchor instructions at the end of this booklet.

Q. **Install the handles.** Refer to the instruction in the hardware box.

R. **Install the strikes/keepers.** Refer to the provided instruction or to the anchor page(s) and adjust as required to ensure handle locks and operates correctly.

**250 Series Doors:** Install the keeper after the sliding panel is confirmed to operate and lock. Then fasten the fixed panel to the door frame.

**IMPORTANT** Install the vent lock strike plate. Refer to the Secure Vent Lock Strike Plate installation document located in the hardware box.

S. **Install vent panel retainers (if applicable)** or reinstall if the vent panel was removed during installation. Refer to the instructions included in the panel retainer hardware package.

**WARNING** Panel Retainer MUST be installed to reduce risk of serious injury or death from a falling door panel. If panel retainer is lost or damaged, DO NOT INSTALL DOOR. Contact your Local Pella Seller or Pella Customer Service (877) 473-5527 for replacement.

## 3 INTEGRATE WITH THE BUILDING WRAP

**NOTICE** For fold-up or slide-in fins, seal the fin to frame joint by either applying flashing tape 1/2" onto the frame, or sealing the joint with installation sealant after placing flashing tape.

### Fin to Frame Seal Flashing Tape Option

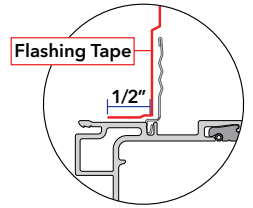

### Sealant Option (Ensure sealant compatibility with flashing materials)

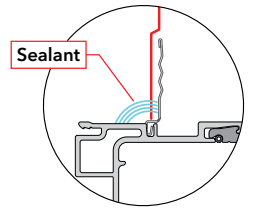

A. **Apply straight side flashing tape.** Cut two pieces of flashing tape 4" taller than straight sides. Apply tape over the fin and onto water resistant sheathing. Extend tape 2" above and below straight sides.

**Doors with angle top transoms or curved tops:** On the short side, do not allow the side tape to extend higher than what the top tape will cover.

B. **Apply top flashing tape.** Cut one piece of flashing tape to extend 1" past both side flashing tapes.

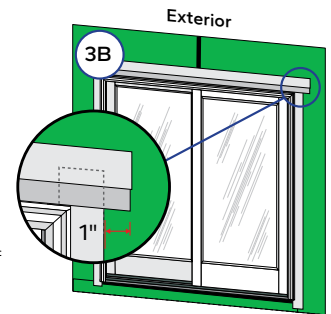

*Note: Steps C-E are required for 4 panel doors with field assembled frames only.*

C. **Apply sealant at the point** where the door frame cladding contacts the nailing fin across the top and at each end of the frame.

D. **Install a head drip flashing.**

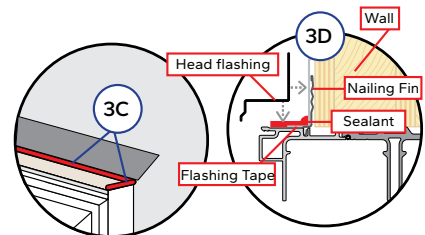

E. **Apply a piece of flashing tape over the head flashing as shown.**

**NOTICE** Press all tape down firmly.

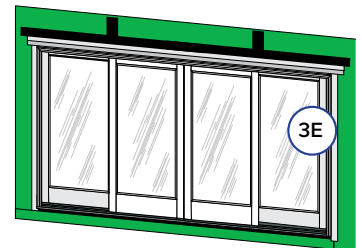

**IMPORTANT** Use a roller to firmly press all flashing tape down until the texture of the sheathing can be seen through the tape.

F. **Install interior sealant.** Refer to the interior sealant instructions at the end of this booklet.

G. **Attach wood blocking to the exterior of the opening** to support the edge of the door sill (doors with sill nail fins only).

H. **Install head flashing,** properly incorporating it with the siding and sealing it into the sheathing according to applicable code requirements.

I. **Install exterior sealant.** (After wall cladding is installed) Refer to the exterior sealant instructions at the end of this booklet.

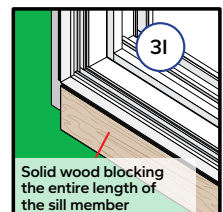



# ANCHOR INSTRUCTIONS - NAIL FIN INSTALLATION METHODS FOR CLAD EXTERIOR PELLA® RESERVE AND PELLA® LIFESTYLE SERIES SLIDING PATIO DOORS

Note: Standard performance only. Additional anchoring may be required for Performance Upgrade or to comply with local building code requirements.

Location	Anchor Type		Instructions	Drawing		
	Wood	Masonry				
Head and Jamb Nail Fin	2" 11 GA Roofing Nail	N/A	Drive nails or modified truss, k-lathe, or wafer headed screws within 4" from corner and 7" on center (every pre-punched hole).	A		
Head	Vent Lock Strike	#10 x 2-1/2" (provided)	1/4" x 2-1/2"	Pilot drill using 5/32" bit and drive (1) screw through Vent Lock Strike.	B	
	Fixed Panel Bracket			Pilot drill using 5/32" bit and drive (1) screw through Fixed Panel Bracket.		
	Frame Screws*			Performance Upgrade or over 95.25" x 95.5" only: Pilot drill using 5/32" bit and drive screws 6" from corners and on either side of meeting stile.	C	
	Interlocker Frame Screws**				OX or XO and Performance Upgrade or over 95.25" x 95.5" only: Add screws 5" on either side of Vent Lock Strike.	C.1
	Joiner Frame Screws				OXXO or OXXO only: Pilot drill using 5/32" bit and drive screws at midpoint of joiner (OXXO) or through joiner part (OXO) and 5" either side of joiner midpoint.	C.2
Installation Clips*	(2) #6 x 1-1/4"	3/16" x 1-1/2"	Performance Upgrade or over 95.25" x 95.5" only: Slide clip into slot from end and adhere to frame with tape 6" from corner and on either side of meeting stile.	D		
Jamb	Lock Strike (OX or XO)	#8 x 3" (provided)	3/16" x 3"	Complete per each strike. Pilot drill using 5/32" bit and install (2) installation screws diagonally. Install cover after screws.	E	
	Lock Strike (OXO or OXXO)	#8 x 1-1/2" (provided)	N/A	Install (2) short screws diagonally. Install cover after screws.	E.1	
	Frame Screws*	#10 x 2-1/2" PH	1/4" x 2-1/2"	Performance Upgrade or over 95.25" x 95.5" only: Pilot drill using 5/32" bit and drive screws 6" from corner and 20" on center.	C	
	Lower Jamb Frame Screws**			OX or XO and 95.25" x 95.5" or under only: Required for units not using sill frame screws. Pilot drill using 5/32" bit and drive screws 6" from the sill.	F	
	Installation Clips*			(2) #6 x 1-1/4"	3/16" x 1-1/2"	Performance Upgrade or over 95.25" x 95.5" only: Slide clip into slot from end and adhere to frame with tape 6" from corner and 20" on center.
Sill	Frame Screws*	#8 x 3" FH or #10 x 2-1/2" FH	1/4" x 2-1/2"	Performance Upgrade or over 95.25" x 95.5" only: Use factory pre-drilled holes (if applicable). Pilot drill with 1/8" bit and apply sealant before driving screws. Not required if Standard Performance OX or XO and 95.25" x 95.5" or under provided Lower Jamb Frame Screws are utilized.	G	

Use corrosion resistant fasteners compatible with construction materials.

For light gauge steel framing, use #10 self-tapping screws with minimum 3 thread embedment.

\* Additional anchors required for Performance Upgrade or frame sizes exceeding 95.25" x 95.5" tall.

\* For Performance Upgrade, install the Performance Upgrade Interlocker. Refer to provided instructions.

\*\* Applicable to Standard Performance 2-Panel (OX or XO) door configurations 95.25" x 95.5" or under only.

Units with Pella EnduraClad exterior trim with narrow fins and no pre-punched holes must be anchored with frame screws or installation clips.

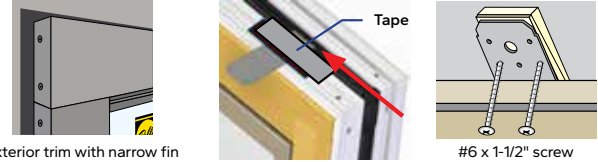

Elevation View

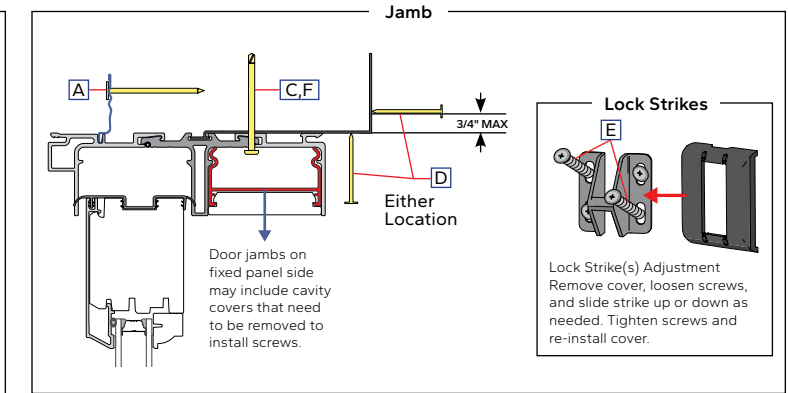
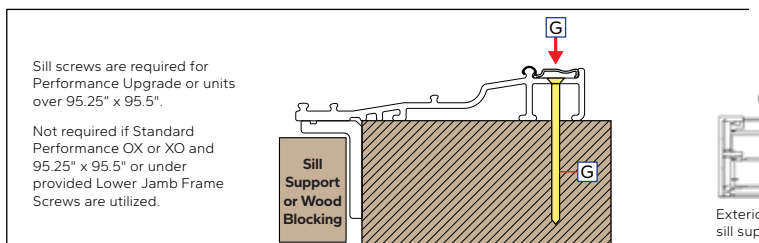
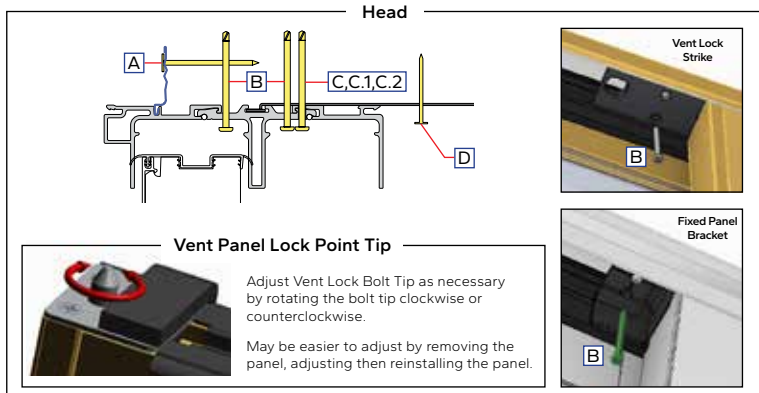
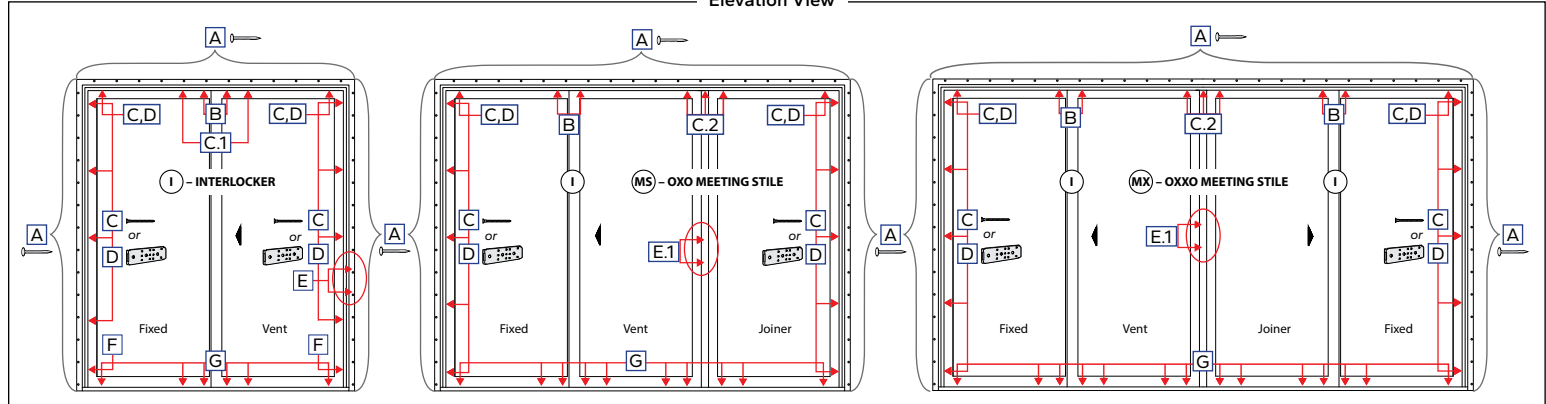



# ANCHOR INSTRUCTIONS – NAIL FIN FRAME INSTALLATION METHODS FOR ENCOMPASS BY PELLA® AND PELLA® 150 SERIES SLIDING PATIO DOORS

Note: Standard performance only. Additional anchoring may be required for performance upgrade, impact-resistant products or to comply with local building code requirements.

Location		Anchor Type		Instructions	Drawing
		Wood	Masonry		
Head / Jamb / Sill Nail Fin		2", 11 Ga. Roofing Nail	N/A	Drive nails in every pre-punched hole	A
Head and Sill – Interlockers only		2", 11 Ga. Roofing Nail	N/A	Place additional anchors, spaced 2" apart, through the nail fin	B
Jamb	Strike / Lock / Keeper	#10 x 2" Corrosion Resistant (provided)	1/4" x 3-1/2" Masonry Screw	Refer to installing the keeper instructions and illustrations below	C
Sill	Frame Screws – Nail fin removed	#10 x 2" Corrosion Resistant (provided)	1/4" x 2" Masonry Screw	Pre-drill and apply sealant then drive screws 4" from corners and 19" on center max spacing.	D

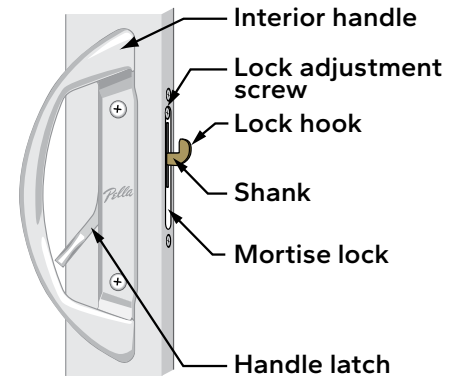
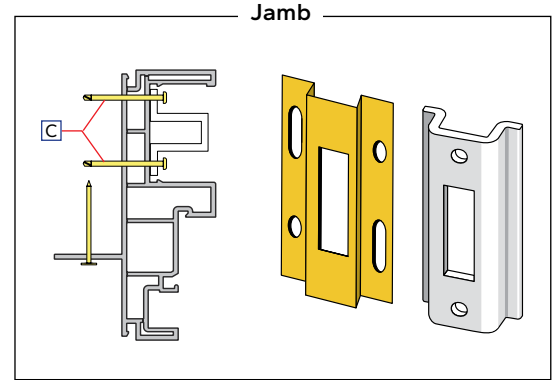
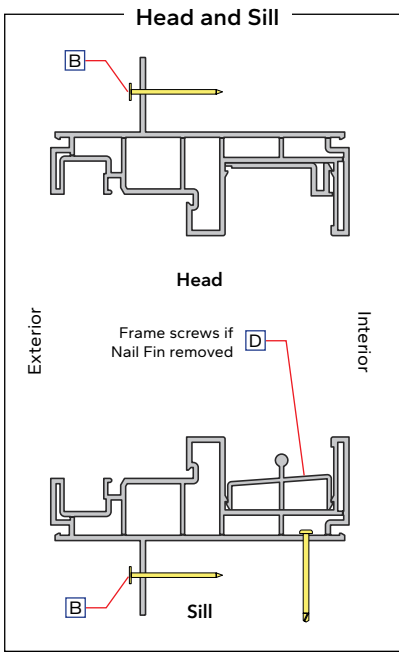
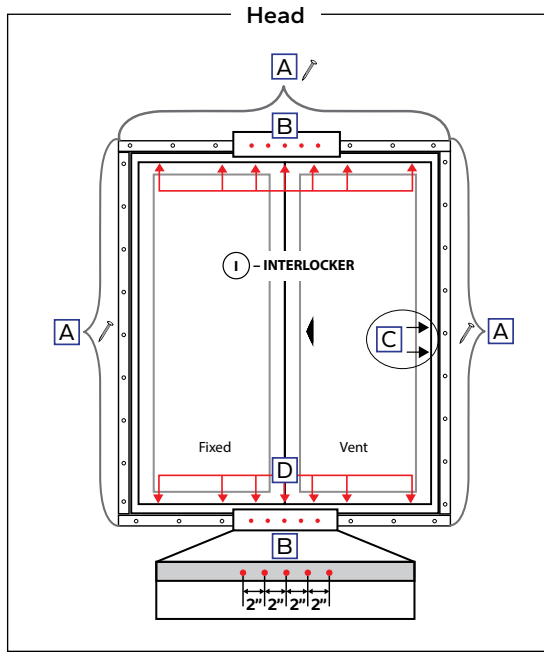

## KEEPER INSTALLATION FOR ENCOMPASS BY PELLA® AND PELLA® 150 SERIES:

- Identify the keeper** in the hardware package and perform the keeper attachment steps based on which keeper is in the package. Determine the keeper location by opening the panel a few inches and extending the lock hook. With a pencil, mark the location on the jamb directly across from the top of the shank.
- Place the keeper with 4 screw holes** on the jamb so the top of the slot is aligned with the pencil mark. Attach by inserting a #6 x 1/2" starter screw into one of the slotted keeper holes.
- Place the keeper with 2 screw holes** on the jamb by "snapping" it into the frame jamb at the desired location. The keeper may be moved up or down to align with the pencil mark. The keeper will stay in position until attached with screws.
- Insert a shim** between the frame jamb and the rough opening at the keeper location.
- Adjust the lock hook** by turning the door lock adjustment screw clockwise to loosen or counter-clockwise to tighten until the mortise lock is aligned properly, the door locks easily, and there is less than 1/16" movement when the door is locked.
- Install the keeper** by inserting 3" long screws (provided) through the keeper holes, the shim and into the rough opening frame members. Remove the starter screw from the 4 screw hole keeper and replace it with a 3" long screw.

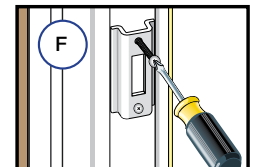
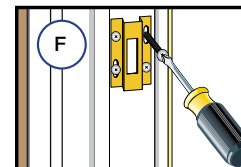
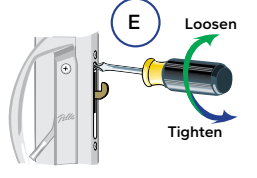
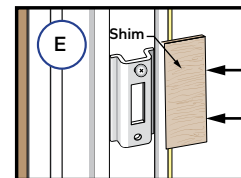
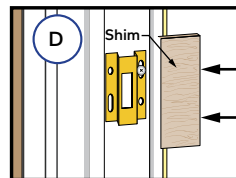
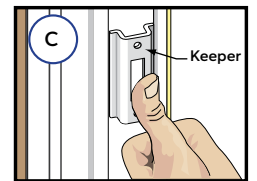
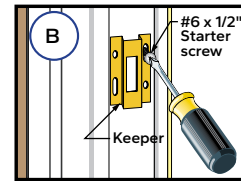
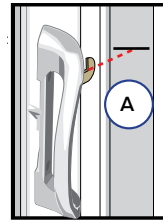



# ANCHOR INSTRUCTIONS – FIN FRAME INSTALLATION METHODS FOR PELLA® 250 SERIES SLIDING PATIO DOORS

Note: Standard performance only. Additional anchoring may be required for performance upgrade, impact-resistant products or to comply with local building code requirements.

Location	Anchor Type		Instructions	Drawing
	Wood	Masonry		
Optional: Head and Jamb Fin*	2" 11 Ga. Roofing Nail	N/A	Optional for squaring and setting purposes only.* Pre-drill and drive nails or #8 modified truss, k-lathe, or wafer-headed screws.	A
Head and Jamb Frame Screws	#10 x 3" Pan Head (provided)	3/16" x 3"	Locate screws 3" from corners and 16" on center. Shim at each screw. Use the score line in the frame as a guide, pilot drill with a 1/8" bit into the opening then drill a 3/8" hole through the first wall only and drive screws. Place caps or plugs (provided) over screw holes (optional).	B
Head Secure Vent Lock Strike			Refer to the provided Secure Vent Lock Strike installation instruction located in the hardware box.	B.1
Jamb	Lock Strike / Keeper (OX, XO, OOX, or XOO)	#10 x 1-3/4" (provided)	Refer to provided instructions. Shim between the frame and the opening and drive four screws through the keeper and into the opening.	C
	Astragal / Meeting Stile Keeper (OXO or OXXO)	#8 x 1" Flat Head (provided)	Refer to provided instructions.	C.1
	Fixed Panel Frame Screws		Place screws evenly spaced into the fixed jamb frame leg where the weatherstrip is located.	D
Head / Sill	OOX/XOO Fixed Panel Screws	#8 x 3/4" (provided)	Place screws 1/2" from the edge of the panels at the interlocker ends through the head and sill frame legs where the weatherstrip is located.	E
Sill	Frame Screws (optional)	#10 x 3" Pan Head	Optional to maintain sill embedment into sealant, pre-drill with 1/8" bit, add sealant, and drive screws. Remove roller track, install screws, reinstall track, seat with block and rubber mallet.	F

Applies to 1" and 1-3/8" Fin setback frames.

Use corrosion resistant fasteners compatible with construction materials.

For light gauge steel framing, use #10 self-tapping screws with minimum 3 thread embedment.

\*For products utilizing FPA / TDI documents, set fin in a bed of sealant and drive fin fasteners within 4" of corners and 12" on center.

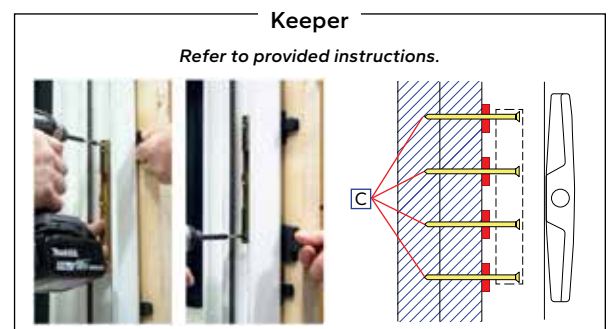
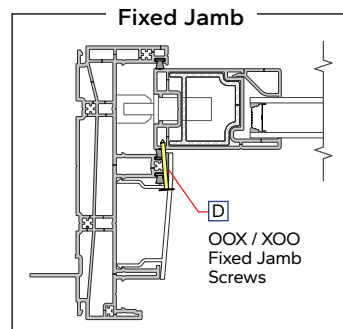
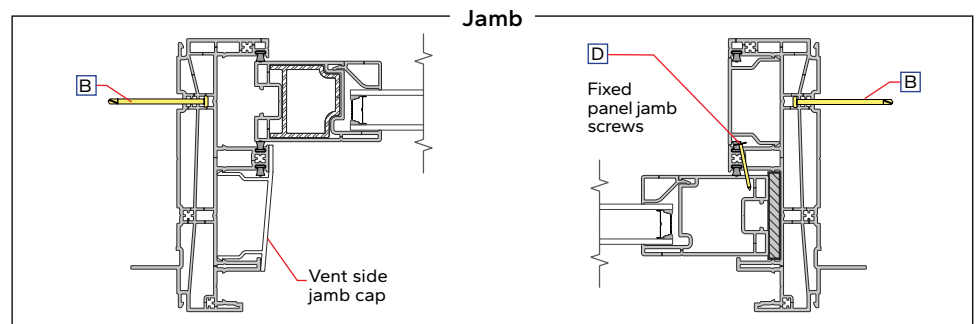
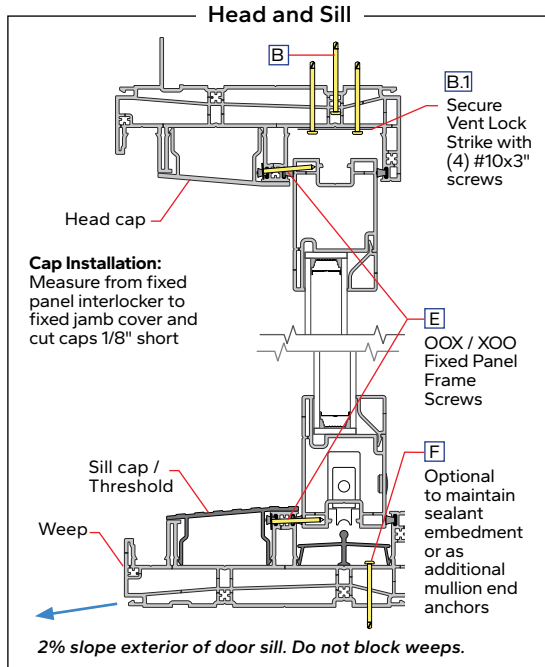
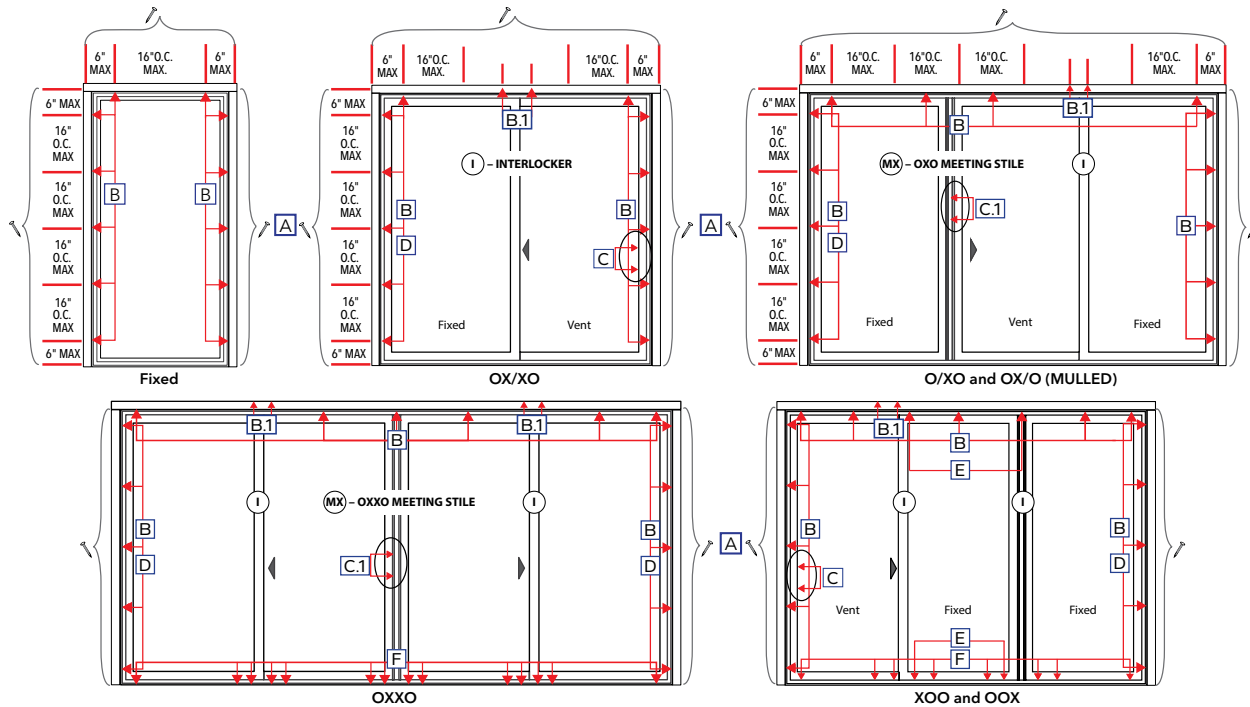



# ANCHOR INSTRUCTIONS - NAIL FIN INSTALLATION METHODS FOR PELLA® IMPERVIA SLIDING PATIO DOORS

Note: Standard performance only. Additional anchoring may be required for performance upgrade or to comply with local building code requirements.

Location		Anchor Type		Instructions	Drawing
		Wood	Masonry		
Head/ Jamb	Nail Fin*	2",11 Ga. Roofing Nail	N/A	Within 3.5" from each corner and 7" on center (every other pre-punched hole). All PG 35 and PG 50 up to 71.25" x 81.50" frame size.	A
	Nail Fin with Frame Screws	#10 x 3" (provided)	3/16" x 1-3/4" Masonry Screw	Use factory-drilled installation holes if present. Drill holes through both walls and into the rough opening using a 1/8" bit then drill a 3/8" hole through the first wall only.	
	Frame Screws	#10 x 3" (provided)	3/16" x 1-3/4" Masonry Screw	Required to meet PG 50 if >71.25" x frame width or >81.50" frame height.	
	Installation Clips	#8 x 1 1/4"	3/16" x 1 1/2"	Slide clips into slot from frame ends. Adhere clip with tape. Not applicable with nail fin	
Sill	Frame Screws	#8 x 3" (provided)	3/16" x 2 1/2" Masonry Screw	Remove inner sill cover. Use factory-drilled installation holes, pilot with 1/8" bit into rough opening. Apply sealant in each hole before driving screws.	C
	Vent Panel Retainer Support	#8 x 3" (provided)	3/16" x 2 1/2" Masonry Screw	Apply sealant in each hole before driving screws. Reinstall sill cover.	
	Fixed Panel Structural Bracket	#10 x 3" (provided)	3/16" x 2 1/2" Masonry Screw	Remove one factory-installed screw first. Pre-drill 3/16". Pilot with 1/8" bit into rough opening. Apply sealant in each hole before driving screws.	
	Aluminum Support	#8 x 3/4" (provided)	NA	Available separately - consult your local Pella representative.	
Mullions*		#10 x 3"	3/16" x 1-3/4" Masonry Screw	Head: Drill holes through both walls and into the rough opening using a 1/8" bit then drill a 3/8" hole through the first wall only. Add sealant prior to driving screws at the sill.	B
Lock Strike		#8 x 3"	3/16" x 1-3/4" Masonry Screw	<b>Grade 40 Security:</b> Install (4) installation screws per strike. <b>Grade 10 Security:</b> Install (2) installation screws (diagonally) per strike. Pilot all installation screw locations with 1/8" bit into rough opening.	D

\*For light gauge steel framing, use #10 self-tapping screws.  
\*\*Anchor through structural mullion end anchors, if present.

\*\*\*Impact-Resistant products must be installed with frame screws. Fin fastening (if applicable) is optional for flashing purposes. Refer to Florida Product Approval documents (if applicable).

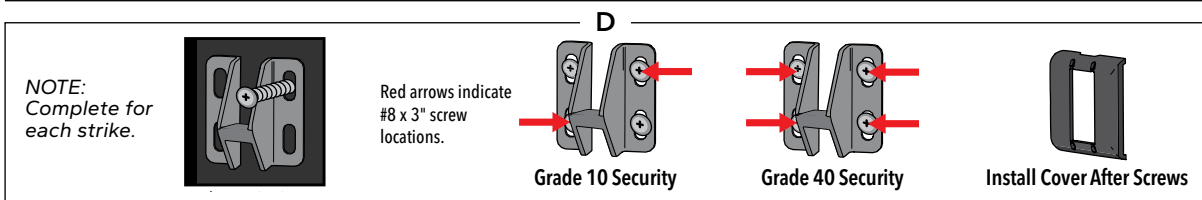
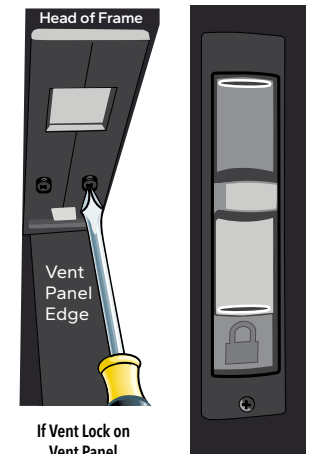
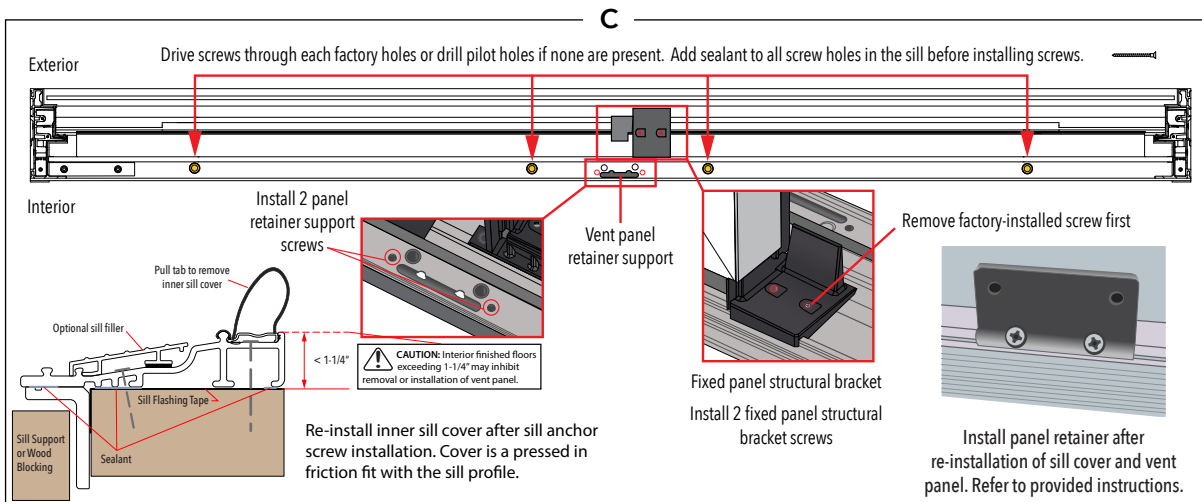
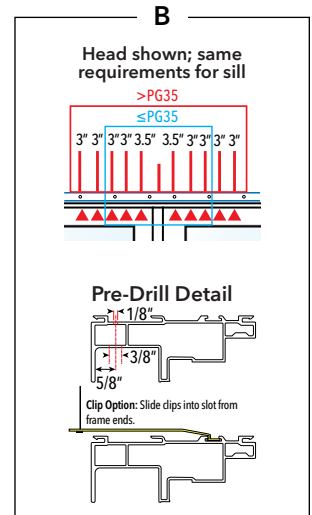
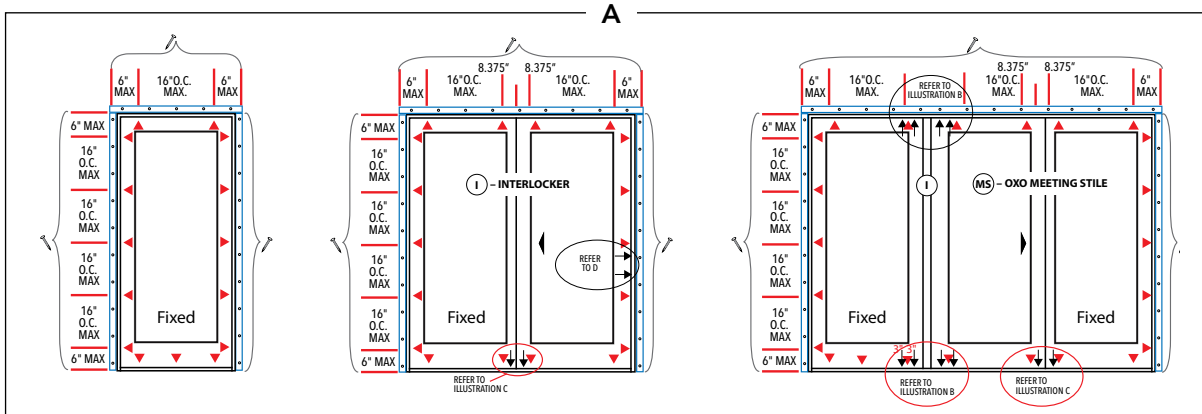



# REVERSING DOOR SLIDE FOR SLIDING PATIO DOORS

Note: Doors with Blinds-Between-the-Glass are not reversible.

## REVERSING DOOR SLIDE FOR ENCOMPASS BY PELLA® AND PELLA® 150 SERIES:

- A. **Remove the sill and screen tracks** from the door. (Use an Allen wrench or small hook to begin removal.)
  - B. **Rotate the main frame 180°** (so the sill becomes the head). Snap the sill and screen tracks into place at the bottom of the door. Carefully lay the panel on saw horses or a clean surface.
  - C. **Extend the lock hook** and clamp the lock hook with the vise grip.
- Note: Use of the vise grip on the lock hook will prevent the mortise lock from falling when the lock mounting screws are removed.
- D. **Remove the door handle** by removing the two attachment screws.

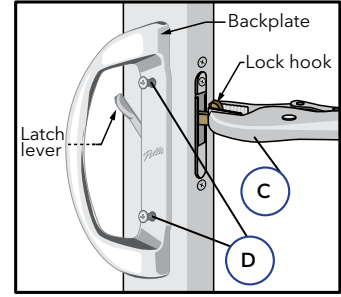

- E. **Remove the mortise lock.** Remove the two screws that attach the lock assembly to the door panel. Work the lock down, then tilt it out and pull up.

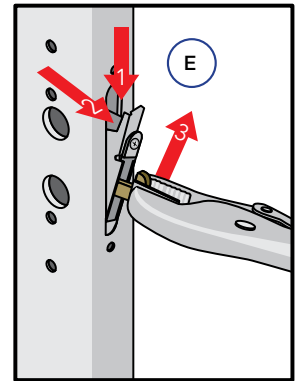
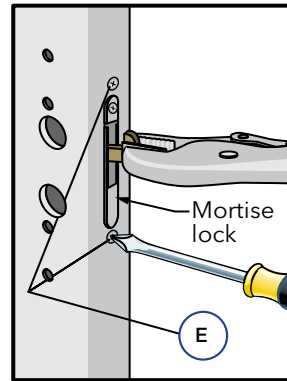

- F. **Rotate 180° and reinstall the lock.** Insert the mortise lock into the door panel with the lock adjusting screw positioned at the bottom, then tilt the top in and lift the lock into position. Insert the two mounting screws into the lock mounting holes.

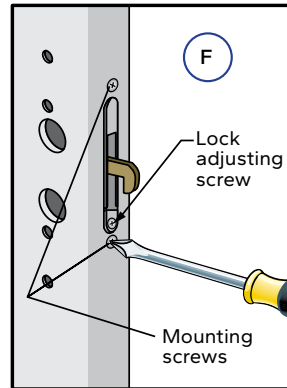

- G. **Rotate the handle 180°** and install the door handle by inserting the two backplate screws through the door panel and into the exterior handle.

Note: Rotating the handle will result in "Pella" script being upside down. A new handle must be ordered for "Pella" to be in correct orientation.

Note: The latch lever must engage the slot in the side of the mortise lock assembly.

- H. **Remove the bottom rollers** from the slide panel by removing the upper screw. Reinstall the rollers in the opposite end of the door panel.

- I. **High Performance Doors only:** Remove the blocks from the top rail of the door panel and reinstall them at the opposite end of the panel.

- J. **High Performance Doors only:** Move the frame exterior vent plugs (white foam rods) from the head of the frame to the opposite side of the frame. A soap solution may be needed as a lubricant for re-installing the plugs.

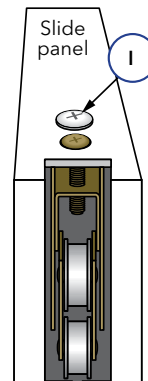



# INTERIOR AND EXTERIOR SEALANT

## INTERIOR SEALANT INSTRUCTIONS

**NOTICE** Continuous backer rod (as necessary) and a high quality, low-odor interior sealant such as Pella Window and Door Installation Sealant (or equivalent) is recommended for commercial or high performance installations to create the continuous interior seal. Follow the directions on the cartridge. For standard performance or products with factory applied jamb extensions, use low pressure polyurethane insulating foams. Follow the directions on the can. Do not use high pressure or latex foams. Fiberglass batt or similar insulation is not recommended as it can absorb water and does not act as an air seal.

- A. Insert the nozzle or straw between the rough opening and door frame from the interior. Use a pliers (if necessary) to compress the end of a straw tube to allow it to fit in tight openings.
- B. Place a 1" deep bead of foam approximately 1" from the interior of the frame to allow for expansion. DO NOT fill the entire depth of the rough opening cavity.

**NOTICE** DO NOT fill the entire depth of the rough opening cavity. Leave exterior one-third (1/3) of cavity open. Apply foam between the frame and rough opening flashing materials, NOT between jamb extensions and the rough opening.

- C. Re-Check door operation and remove remaining shipping spacers after foam installation. Excess foam may be removed with a serrated knife after it cures.
- D. To ensure a continuous interior seal, apply sealant over or around any shims or clips interrupting the foam seal.
- E. Place a continuous bead of sealant across the inner sill at the intersection of the door sill and subfloor. Continue the sealant 6" up each jamb and connect with the foam seal.

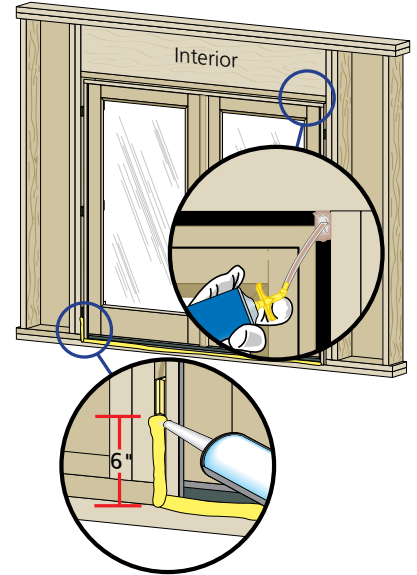

## EXTERIOR SEALANT INSTRUCTIONS

**NOTICE** Use a high quality, multi-purpose exterior sealant such as Pella Window and Door Installation Sealant. Follow the directions on the cartridge.

When applying siding, brick veneer, flashing, or other exterior finish materials, leave adequate space between the door frame and the material for sealant application of sealant.

- A. Insert backer rod 3/8" deep in the space around the door. Backer rod adds shape and controls the depth of the sealant line.
- B. Apply a continuous bead of sealant to the entire perimeter of the door.

**NOTICE** For sill pans designed to drain moisture directly to the exterior, voids in the exterior seal may be required.

- C. Shape, tool and clean excess sealant. When finished, the sealant should be the shape of an hourglass.

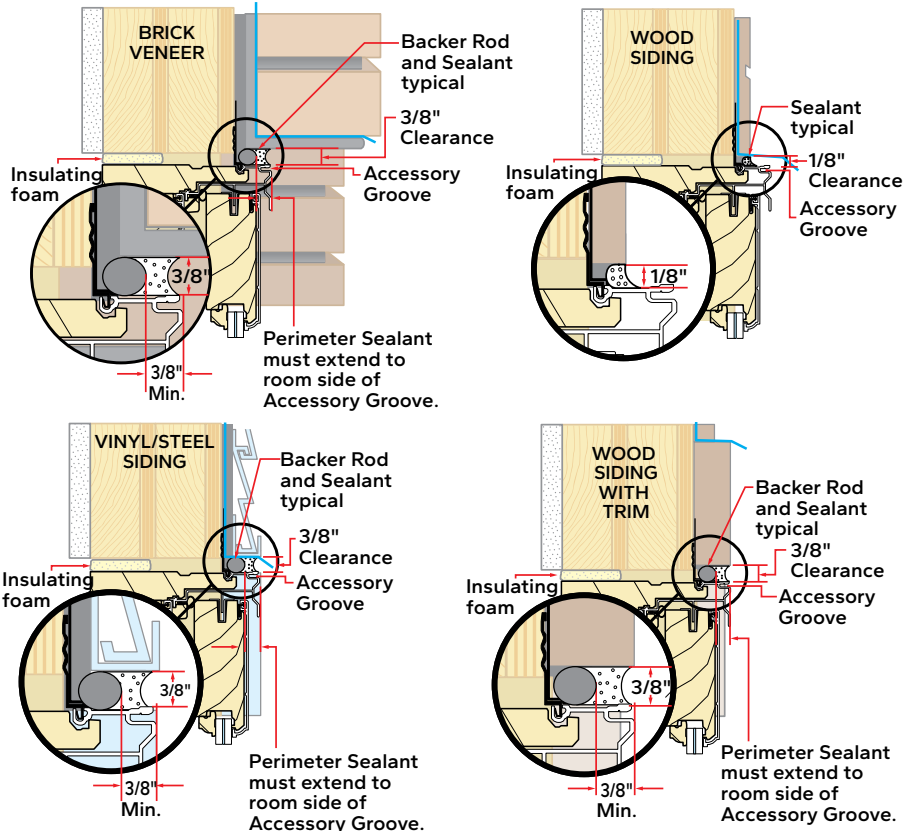
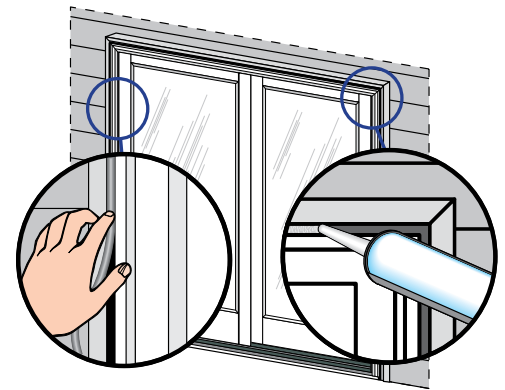



# OPTIONAL SILL PAN INSTRUCTIONS

**NOTICE** The method of pan construction, flashing, and sealant application may vary depending on the design of the opening sill and exterior landing surface conditions. It is important to consider the exposure to weather, the exterior landing surface's proximity to the door sill, and to confirm impervious exterior surfaces properly slope away from the door.

A. **Cut the sill pan** to the width of the rough opening plus 2".  
*Note: The 2" added onto the rough opening width is for a 1" bend on each end.*

B. **Make a 1" cut** in each fold at both end of the sill pan.  
*Note: These cuts will allow the edges of the sill pan to be bent.*

C. **Cut 1" off each end** of the interior sill pan lip.

D. **Bend each end** of the center panel up.

E. **Install the sill pan** by sliding into place until the exterior sill pan lip is flush with the exterior of the rough opening.

F. **Apply sill flashing tape.** Cut a piece of flashing tape 2" longer than the opening width. Apply at the bottom of the opening, covering the exterior sill pan lip as shown.

*Note: If applicable, apply spray adhesive to building felt prior to applying the flashing tape.*

G. **Cut a piece of flashing tape** to the width of the opening. Install tape to the sill pan and overlap the flashing tape from step 1F by 1". If needed add a second or third piece of flashing tape until the sill pan is covered to the interior sill pan lip.

*Note: The purpose of this tape is to seal the sill screws when installing the door.*

H. **Cut two 9" pieces of flashing tape** with a 1" x 3" tab at the bottom, on opposite corners as shown.

I. **Apply the tabbed 9" pieces of flashing tape.** The tape is applied so 2" will cover the inside of the rough opening and lap over the side flange of the sill pan. The 1" x 3" tab laps over the bottom flashing tape as shown.

J. **Cut two 6" pieces of flashing tape** and apply to each side of the rough opening, overlapping the first piece by 1" and lapping the bottom over the side flange of the sill pan as shown.

K. **Cut two pieces of flashing tape 1-1/2" x 6"** and apply to the bottom corners of the opening by beginning in the corner of the sill pan, with 3/4" of the tape applied to the sill pan and 3/4" of the tape applied to the side flange. The remainder of the tape is to be at a 45 degree angle onto the exterior.

L. **Attach the aluminum sill support** or wood blocking to the exterior of the box plate to support the edge of the door sill. Place the sill support flush with the subfloor.

## CONCRETE SLAB (WITHOUT SILL PAN) INSTRUCTIONS

*Note: Thoroughly clean the slab where sealants will be installed. Instead of installing flashing tape across the bottom of the rough opening, complete the following:*

- A. **Install flashing tape** at the bottom 6" of the rough opening jambs.
- B. **Cut (2) 9" pieces of flashing tape** as shown in step 1H above.
- C. **Install them overlapping** the flashing tape installed in step A by 1".
- D. **Place a 3/8" bead of sealant** where the bottom edge of the flashing tape meet the concrete slab.
- E. **When folding building wrap in at the jambs**, cut at a 30 degree angle as illustrated.

*Follow the applicable installation method pages to complete the installation except seal the door sill directly to the slab.*

