



PELLA® 250 SERIES SLIDING PATIO DOOR 4-PANEL KNOCK-DOWN ASSEMBLY INSTRUCTIONS

Parts List:

- Head
- Jamb (x2)
- Sill
- Astragal
- Fixed Interlocker Panel x2
- Vent Panel x2
- Assembly Parts Bag(s)

Tool List:

- Powered driver with #2 Phillips drive bit
- #2 Phillips screwdriver with 6" shaft

SEE PAGE 3 FOR SAFETY INFORMATION.

BEFORE REMOVING PREVIOUSLY INSTALLED DOOR AND BEGINNING FRAME ASSEMBLY AND INSTALLATION:

Read through and understand all the assembly steps.

Confirm all the critical parts, factory installed parts and assembly parts as shown in images below are installed in the frame members as noted.







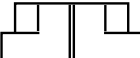
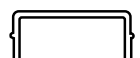
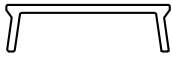
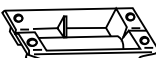

These parts are Assembly and/or Installation Critical!

If any parts are missing...

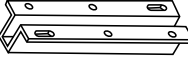

DO NOT assemble! Contact Pella Customer Service at: 877-473-5527.

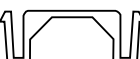
Parts list continued on next page...

Critical Part	Qty	Reason Critical
 Frame Gasket	4–Factory installed on each end of jamb parts.	Water seal at jamb to sill and jamb to head frame corners.
 Flexible Fin	2–Located in BAG B.	Seals top of jamb to head frame corners.
 Sill Filler	2–Factory installed on fixed panel side of sill.	Required for proper fixed panel position in the frame.
 Fixed Panel Spacer	3–Factory installed in fixed jamb (LH) 3–Factory installed in fixed jamb (RH).	Required for proper fixed panel position in the frame against the fixed jamb.
 Anchor (Sill)	2–Factory installed and attached w/ screws in the sill.	Required to secure fixed panel to frame.
 Anchor (Head)	2–Factory installed loose in the head, but not attached w/ screws.	Required to secure fixed panel to frame.
 Interlocker Cover Bushing	4–Included in assembly parts bag.	Guides interlocker cover screw.
 Interlocker Cover	4–Included in assembly parts bag.	Secures fixed panel to frame.
 Sill Track	2–Installed in the sill, must be removed for frame installation.	Required for vent panel operation.
 Lock Strike	1–Factory installed on astragal.	Required for proper locking of door.
 Lock Hardware	1–Installed in the vent panel.	Required for proper locking of door.
 Handle Assembly	2–Shipped separate from door, must be installed into vent panel and joining panel.	Required for proper locking of door.
 Anti-Lift Clip	4–Factory installed in the head. 2–Factory installed in the astragal.	Prevents unwanted vent panel removal. Allows for proper panel alignment.
 Threshold	1–Factory installed in the sill.	Required in sill frame for proper operation.



Always read the Limited Warranty before purchasing or installing Pella® products. By installing this product, you are acknowledging that this Limited Warranty is part of the terms of the sale. Failure to comply with all Pella installation and maintenance instructions may void your Pella product warranty. See written Limited Warranty for details, including exceptions and limitations at pella.com/warranty, or contact Pella Customer Service at 877-473-5527.

BEFORE BEGINNING FRAME ASSEMBLY AND INSTALLATION (CONTINUED):

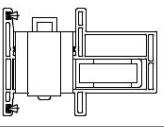
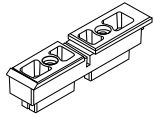
Critical Part	Qty	Reason Critical
 <p>Astragal</p>	1- Shipped separately	Required for proper locking of door.
 <p>Astragal Extensions</p>	2 - 1 factory-installed with mohair in each end of astragal	Required for proper astragal alignment and operation

Frame Gasket on both ends of each jamb. Inspect to confirm it is not torn or damaged.

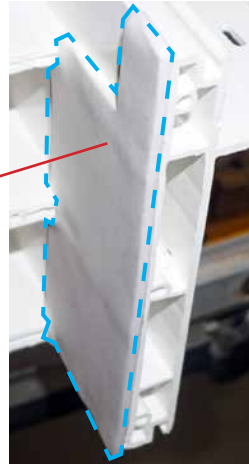

If gasket is missing...



DO NOT assemble! Contact Pella Customer Service at: 877-473-5527.

Parts and Screw Packages:

Confirm all labeled screws bags listed are present. If any screws are missing, please obtain comparable screws from your local hardware retailer. Screw packages may include extra screws.

Bag A #8x2-1/2" Phillips Truss Head Screw - Frame Corner and Interlocker Cover
 Label part #: 829Y0002 *Pella*



Bag B Flexible Fin Corner Package, White
 Label part #: 829Y0000 *Pella*

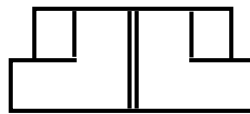

Installation screw and cap package.



Note: Installation screws and caps may be in more than one bag.

Bag D #8x1/2" Phillips Panhead Screw - Head Anchor, Astragal Anchor, Interlocker Cover, White
 Label part #: 829Y0003 *Pella*



Bag E #8x2" Phillips Panhead Screw - Lock Strike, White
 Label part #: 829Y0006 *Pella*

NOT INCLUDED IN OXXO UNITS



Bag E is not included for OXO units

Bag F #8x3/4" & #8x2-1/4" Phillips Panhead Screw - Astragal Lock Strike
 Label part #: 829Y0012 *Pella*





IMPORTANT SAFETY AND PRODUCT INFORMATION – DOORS

CAUTION: Many doors in older homes are painted with lead-based paint. Removal of old doors may disturb this paint. Proper precautions must be taken to minimize exposure to dust and debris. Consult state or local authorities and/or go to www.epa.gov/lead for more information.

WARNING: To ensure safety and security and help prevent property damage, including possible damage to your window or door, close and lock windows and doors any time they are not being used for venting on a nice day, and particularly during high winds or rain.

IMPORTANT NOTICE

Because all construction must anticipate some water infiltration, it is important that the wall system be designed and constructed to properly manage moisture. Pella Corporation is not responsible for claims or damages caused by anticipated and unanticipated water infiltration; deficiencies in building design, construction and maintenance; failure to install Pella products in accordance with Pella's installation instructions; or the use of Pella products in wall systems which do not allow for proper management of moisture within the wall systems. The determination of the suitability of all building components, including the use of Pella products, as well as the design and installation of flashing and sealing systems are the responsibility of the Buyer or User, the architect, contractor, installer, or other construction professional and are not the responsibility of Pella.

Pella products should not be used in barrier wall systems which do not allow for proper management of moisture within the wall systems, such as barrier Exterior Insulation and Finish Systems (EIFS) (also known as synthetic stucco) or other non-water managed systems. Except in the states of California, New Mexico, Arizona, Nevada, Utah and Colorado, Pella makes no warranty of any kind on and assumes no responsibility for Pella windows and doors installed in barrier wall systems. In the states listed above, the installation of Pella Products in barrier wall or similar systems must be in accordance with Pella's installation instructions. Product modifications that are not approved by Pella Corporation will void the warranty.

CARE AND MAINTENANCE

Care and maintenance information is available by contacting your local Pella retailer. This information is also available at www.pella.com.

CLEANING INSTRUCTIONS

GLASS—Remove any protective film and labels and clean the glass, using a soft, clean, grit-free cloth and mild soap or detergent. Be sure to remove all liquid by wiping dry or use a clean squeegee.

FACTORY FINISHED PRODUCT: Pella Product that has been prefinished with stain or paint from the factory requires no additional finishing. Clean the surface with mild soap and water.

PELLA® ALUMINUM CLAD OR IMPERVIA FRAMES: The interior and exterior frame and panels are protected with a tough factory finish. Clean this surface with mild soap and water. Stubborn stains and deposits may be removed with mineral spirits. DO NOT use abrasives. DO NOT scrape or use tools that might damage the surface.

ENCOMPASS BY PELLA®/THERMASTAR BY PELLA® AND PELLA® 350 SERIES DOOR FRAMES: The vinyl frame may be cleaned using the same method as the glass. For stubborn dirt, a "non-abrasive" cleaner such as Bon-Ami® or Soft Scrub® may be used. Do not use solvents such as mineral spirits, toluene, xylene, naphtha or muriatic acid as they can dull the finish, soften the vinyl and/or cause failure of the insulated unit seal. Keep door tracks clear of dirt and debris. Keep weep holes open and clear of obstructions.

DO NOT use abrasives. DO NOT scrape or use tools that might damage the surface.

NOTICE: DO NOT use inappropriate solvents or brickwash or cleaning chemicals. If you do, permanent damage can result and the product failure, loss or damage would not be covered by the Limited Warranty.

FINISHING INSTRUCTIONS (WOOD PATIO DOORS AND FIBERGLASS ENTRY DOORS)

Paint or finish immediately after installation.

If products cannot be finished immediately, cover with clear plastic to protect from dirt, damage and moisture. Remove any construction residue before finishing. Sand all wood surfaces lightly with 180 grit or finer sandpaper. DO NOT use steel wool. BE CAREFUL NOT TO SCRATCH THE GLASS. Remove sanding dust. Pella products must be finished according to these instructions; failure to follow these instructions voids the Limited Warranty. Finishing panel edges is optional for Patio Doors.

Note: To maintain proper product performance do not paint, finish or remove the weatherstripping, mohair dust pads, gaskets or vinyl parts. Air and water leakage will result if these parts are removed. After finishing, allow venting Doors and doors to dry completely before closing them. If paint, stain or finish gets on the weatherstripping, wipe it off immediately with a damp cloth.

Panel Cleaning and Prep Instructions for Unfinished or Primed Panels: Dry wipe dust from doors gently. Examine door for possible smudges or fingerprints made from normal handling or construction. To remove smudges, lightly wipe surface with warm water. DO NOT sand surface of fiberglass panel. Scuff sand with light grade sand paper or abrasive pad (220 grit or higher). Rinse surface with mineral spirits for fiberglass panels and warm water for steel panels. Let door and sidelight surfaces dry completely before applying finish. Finish the door panels as soon as possible after installation.

STAINING FIBERGLASS PANELS OR UNFINISHED INTERIOR FRAME MEMBERS: Fiberglass door and sidelight panels may be stained with a gel stain if a wood look is desired. Pella offers stain kits in a variety of colors. Apply and finish per the stain kit manufacturer's instruction. Ensure that all exposed panel edges are finished to minimize the chance of damage.

Unprimed interior frame parts may be stained with wood stains and should be finished with a minimum of two coats of a clear polyurethane finish. DO NOT bridge the top coat between the outer edge of the glazing frame and the door panel.

Note: The fiberglass base color tone will vary. This variance is normal and will not impact the stain color of the door.

PAINTING INSTRUCTIONS: Wood door frame exteriors, premium steel door panels and sidelights are factory primed. Wood doors require painting immediately after installation. The factory applied primer is not intended for long term exterior exposure. Sand all un-primed interior wood surfaces lightly with 180 grit or finer sandpaper before priming and painting. Fiberglass door and sidelight panels do not require priming. Use two coats of a 100% latex paint that has a good blocking resistance. On units with glass, do not bridge paint between the outer edges of the glazing frame and the door panel. On fiberglass products, brush the paint in the same direction as the simulated wood grain. For entry doors, ensure that all exposed panel edges are finished to minimize the chance of panel damage. Finishing panel edges is optional for Patio Doors.

Pella Corporation is not responsible for interior paint and stain finish imperfections for any product that is not factory-applied by Pella Corporation. For additional information on finishing see the Pella Owner's Manual or go to www.pella.com.

The use of unapproved finishes, solvents or cleaning chemicals may cause adverse reactions with door materials. Pella will not be responsible for problems caused by the use of unapproved materials. If in doubt, contact your local retailer or representative.

EXTERIOR FINISH OF EXISTING FRAME (POCKET REPLACEMENT)

It is the responsibility of the homeowner, contractor or installer to ensure any exposed unfinished wood is covered or finished. Possible methods include, however are not limited to, covering with aluminum coil stock or painting.

1 Sill Prep:

A. Remove the threshold and each sill track with bumper from the sill frame.

Threshold



Sill Track



Frame Layout and Assembly OVERVIEW:

OVERVIEW / PREVIEW ONLY. OVERVIEW / PREVIEW ONLY. OVERVIEW / PREVIEW ONLY. OVERVIEW / PREVIEW ONLY.

Overview only, follow process steps on the following page.

Lay parts on a flat hard surface with exterior side up. Labels attached to the side of the frame parts identify each part to assist in correct part positioning prior to assembly.

TIP: Lay frame parts out with wood blocks under each corner.

Screw packages may include extra screws.

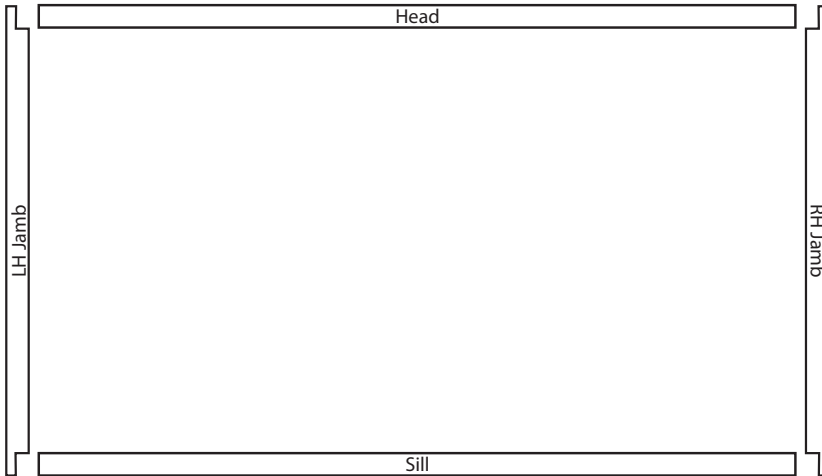

Block Frame

Exterior

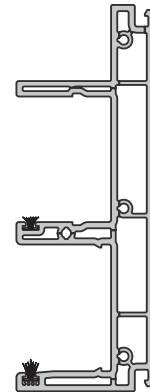

Interior

Nail Fin Frame

Exterior

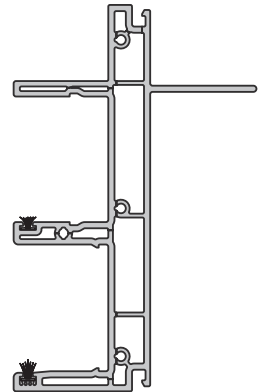

Interior

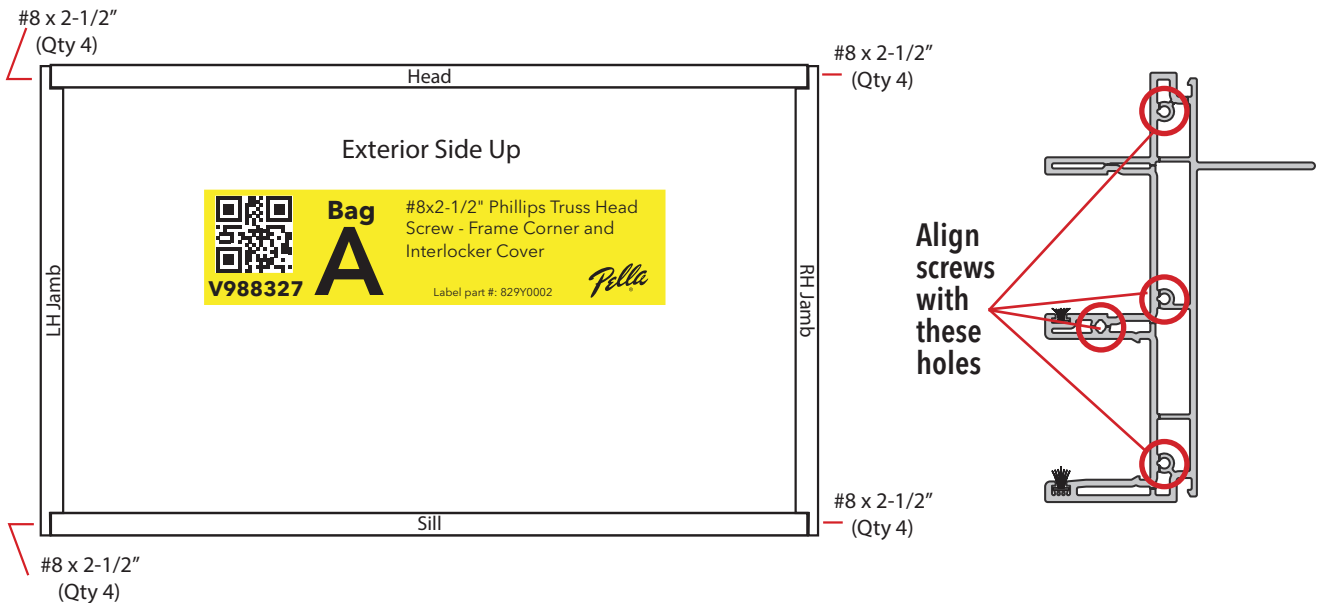

2 Frame Assembly PROCESS:



- A. **Starting in one frame corner**, insert (Qty 4) screws from Bag A into the frame by driving the screws first through the jamb, (use care to not tear the jamb gasket), so they protrude on the exit side. Align each screw with the screw holes in the matching frame part. Start all 4 screws in the matching frame part (head or sill) before fully tightening the screws. Do not overtighten.

Tip: Finish tightening by hand.



NOTICE: Do Not tighten screws past a slight dimple. Overtightening the screws may damage the vinyl parts.

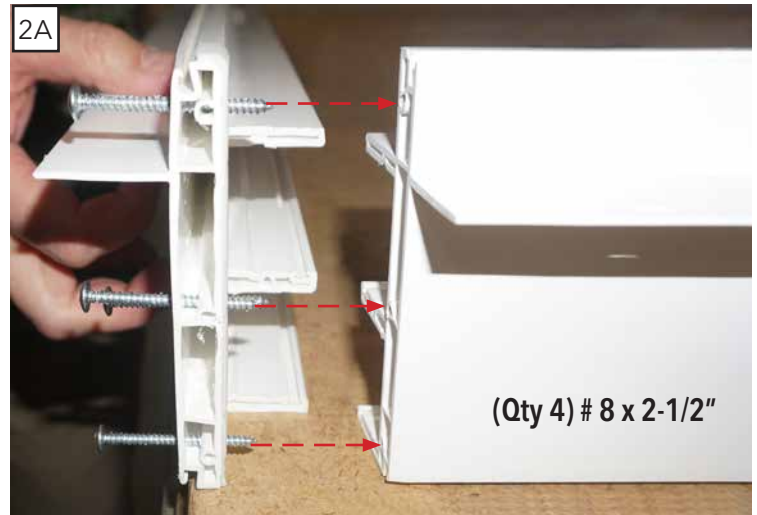

- B. **Continue to work around the frame** until all four corners are assembled.

Note: Extra screws may be included and may also be used in subsequent steps. Do Not throw out extra screws.



3 Flexible Fin Corner Installation:

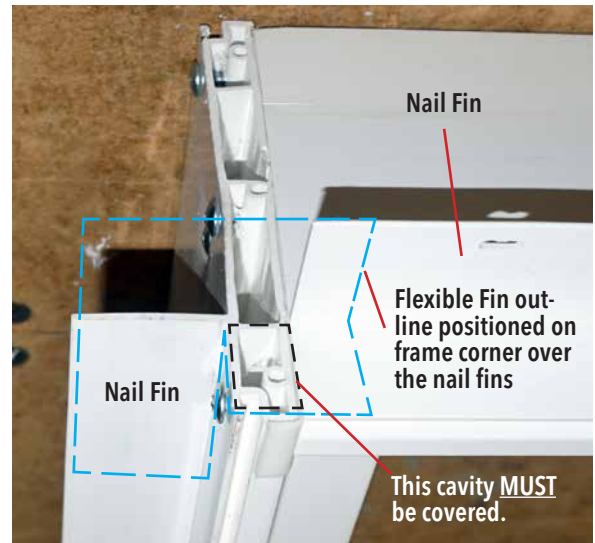
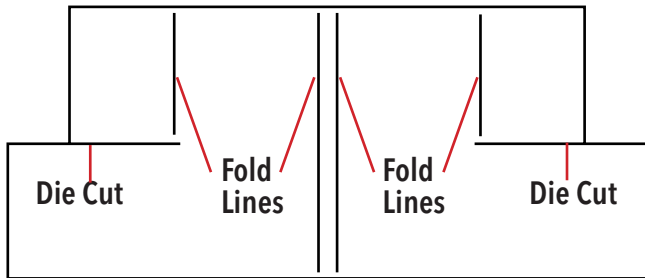

- A. **Nail fin product:** From Bag B, at each of the assembled top two corners of the frame, remove release paper from provided flexible fin corner and fold to install the fin corner over the installation fins, making sure the exterior corner is covered.

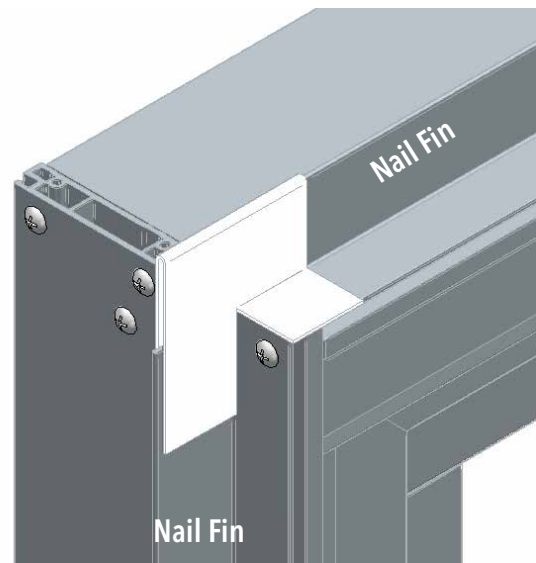

- B. **Block frame product:** From Bag B, at each of the assembled top two corners of the frame, remove release paper from provided flexible fin corner, and install the fin corner over the edges of the corner as shown. Trim flush with interior edge as needed.

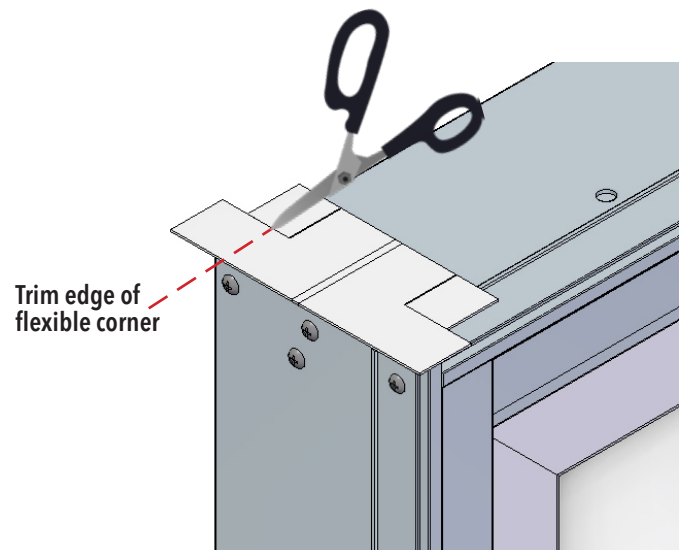

4 Frame Installation into Rough Opening:

Install the assembled door frame into the rough opening using the applicable Pella Installation Instructions. Visit InstallPella.com or your local Pella retailer for complete installation instructions. Installation screws and caps are included in the Parts and Screw package.

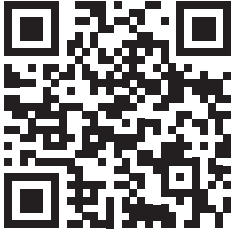

Scan for InstallPella.com



5 Sill Track Installation:

- A. **Re-install the sill tracks with bumper into sill.** Make sure the longer outside track leg is toward the interior and the shorter leg toward the exterior. The sill tracks must slope toward the exterior. The bumper goes against the frame on the fixed panel side. Push down until the track “snaps” into position.

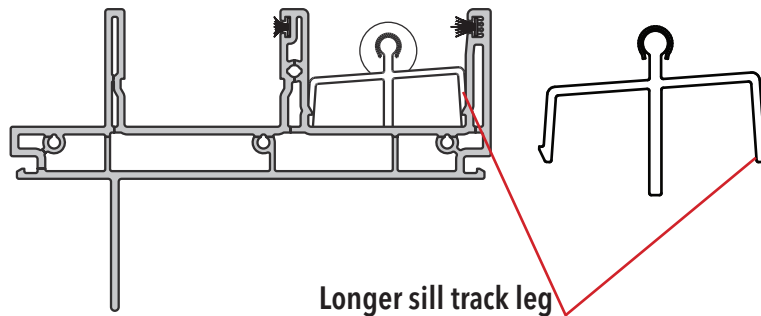

4-PANEL CONFIGURATIONS (as viewed from the exterior):

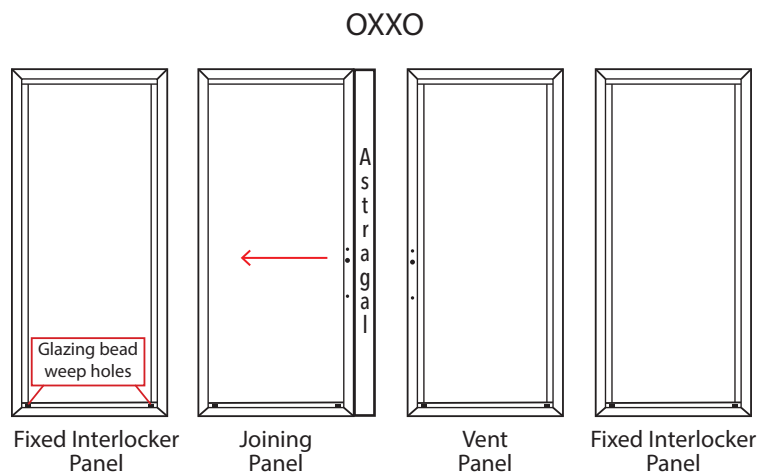

Fixed Interlocker Panels Installation OVERVIEW:

OVERVIEW / PREVIEW ONLY. OVERVIEW / PREVIEW ONLY. OVERVIEW / PREVIEW ONLY. OVERVIEW / PREVIEW ONLY.

Overview only, follow process steps on the following page.

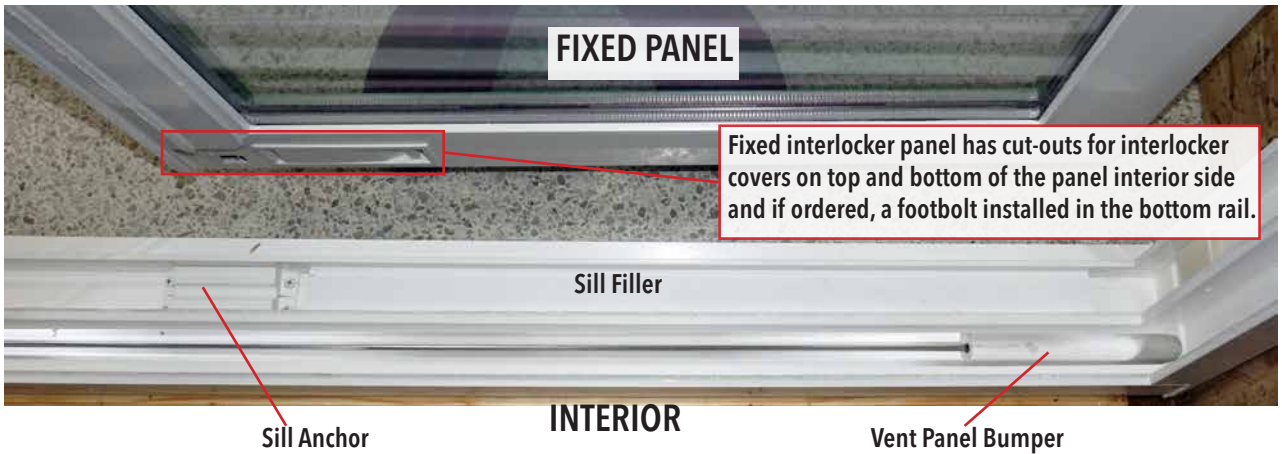

Note: The fixed interlocker panel is installed on top of the factory-installed sill filler and sill anchor. The vent panel bumper is also factory-installed.

Note: When installing the panels; make sure the exterior glazing beads with weep holes are at the bottom of the panel.

OXXO – Exterior View

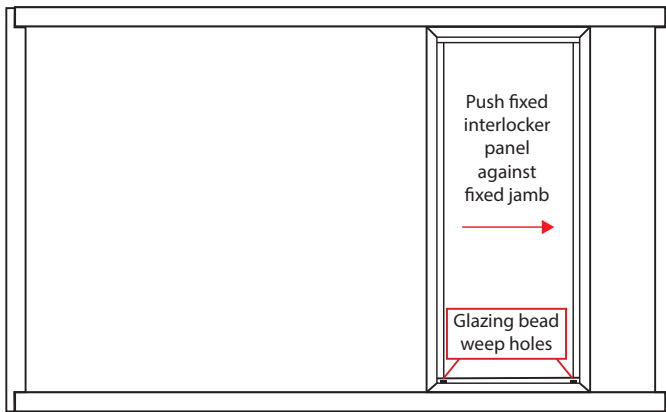

OXXO – Exterior View

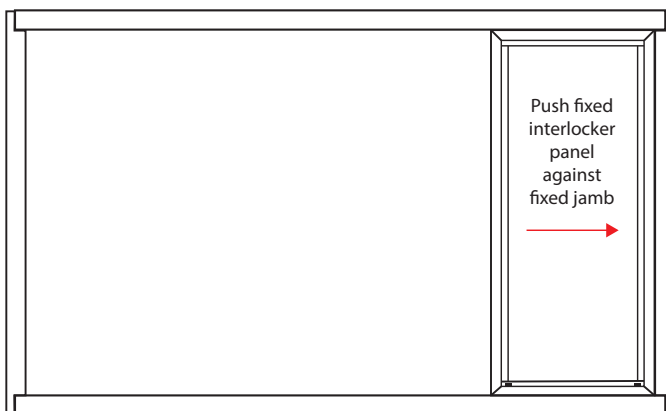

For complete Interior View - See page 12.

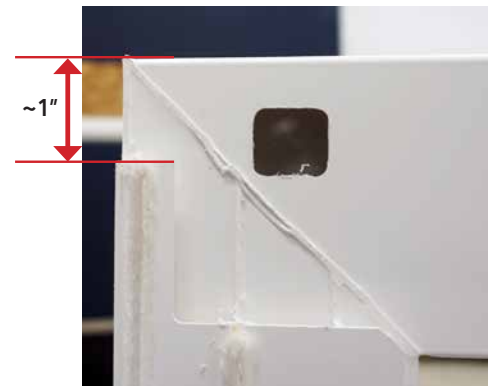

Interior view - top corner of interlocker panel



Interior view - bottom corner of interlocker panel

6 Fixed Interlocker Panel Installation PROCESS:

- A. **Confirm the head anchor** (located in the head) is slid to the vent side, so as not to interfere fixed panel installation.

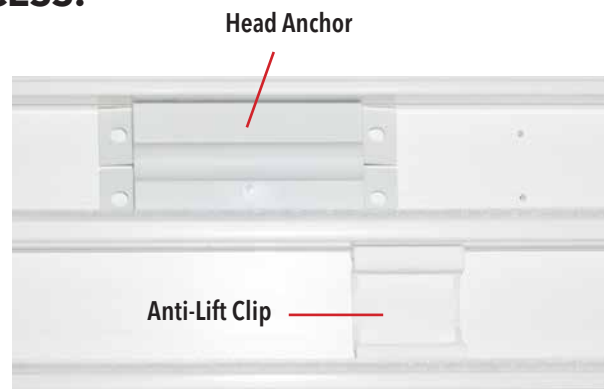

- B. **Confirm all three panel spacers are installed** in the jamb (top, middle & bottom).



If the panel spacers are missing when the fixed interlocker panel is installed, the door will likely not lock.

DO NOT install panel, contact Pella Customer Service at: 877-473-5527.

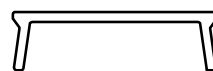

Panel Spacer

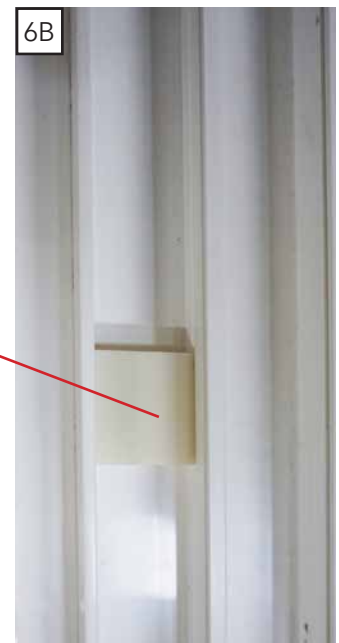
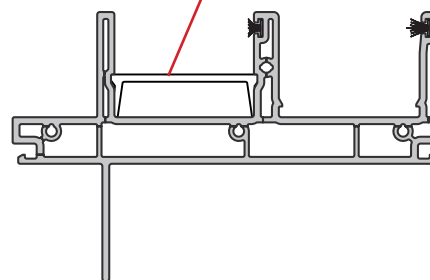

- C. **From the exterior**, lift the fixed interlocker panel up and insert the top of the panel into the exterior head track. Make sure the panel is positioned so the weep holes on the exterior glazing beads at the bottom of the panel.

- D. **Slide the bottom** of the panel into a vertical position.

- E. **Place the panel bottom** into the exterior sill pocket.

Note: The fixed interlocker panel does NOT get installed over the sill roller track.

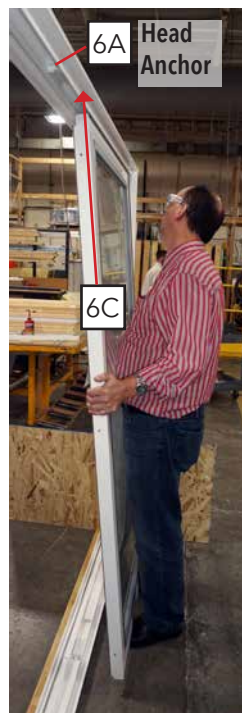

6 Fixed Interlocker Panel Installation PROCESS (continued):

F. Push the panel into position against the jamb and confirm the fixed panel is properly positioned against the jamb by measuring the exposed portion of the panel at top, middle and bottom. Measurement should be ~2-5/8".

If measurement is greater than 2 3/4", pull the panel out of the jamb and re-position it into the jamb to assure it is fully seated against the panel spacers.

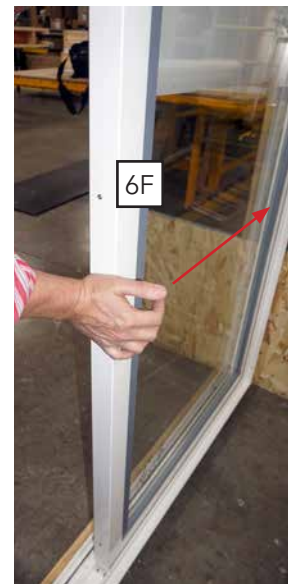
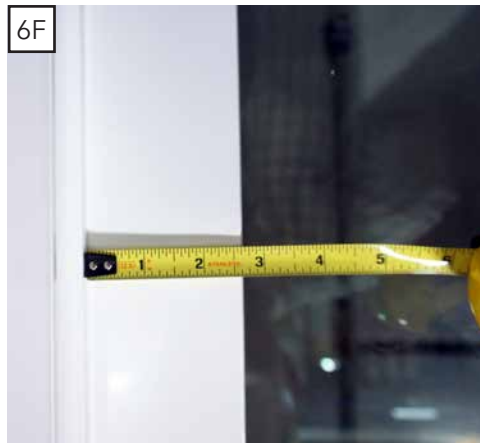

G. Repeat 6A-6F on the other fixed interlocker panel.

OXXO – Exterior View

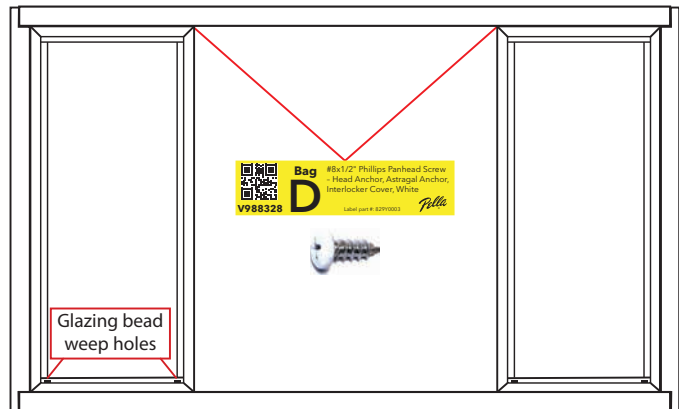

H. Slide the head anchor above the edge of one fixed interlocker panel and align the anchor screw holes with the pre-drilled holes in the frame head. Install and tighten by hand (Qty 2) - #8 x 1/2" painted pan head screws from Bag D.



 **Bag D** #8x1/2" Phillips Panhead Screw - Head Anchor, Astragal Anchor, Interlocker Cover, White
V988328 Label part #: 829Y0003 *Pella*



Interlocker Cover Installation OVERVIEW:

OVERVIEW / PREVIEW ONLY. OVERVIEW / PREVIEW ONLY.

Overview only, follow process steps below.



Install short screw first.

Insert Interlocker Cover Bushing into Interlocker Cover.

Install 2-1/2" screw through Interlocker Cover through busing.

Bushing in accessory bag; only screws are in the numbered accessory bags.

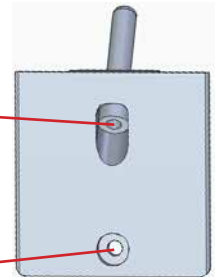

IMPORTANT - Install short screw first!

Interlocker Cover

OXXO – Interior View

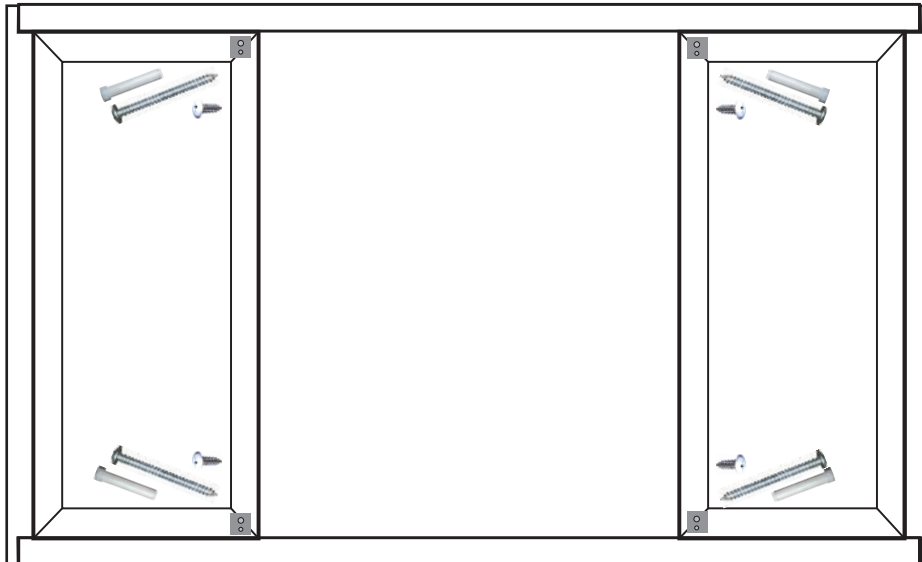

7 Interlocker Cover Installation PROCESS:

- A. Position the fixed interlocker cover in the cut-out at the top edge of the fixed panel with the angle screw hole at the top.



7 Interlocker Cover Installation PROCESS (continued):

B. Insert from Bag D (Qty 1) #8 x 1/2" into the bottom screw hole. Finish tightening the screw by hand.



C. Insert Interlocker Cover Bushing into the interlocker cover before installing the 2-1/2" screw.



D. Complete the interlocker cover attachment by inserting the Bag A (Qty 1) 8 x 2 -1/2" screw in the top cover hole toward the rough opening and finish tightening by hand.



Repeat 7A - 7D on the lower interlocker cover, flipping the cover vertically. For the lower interlocker cover, be sure to install the 1/2" screw in the top hole first and the bushing and the 2 -1/2" screw in the bottom hole second.

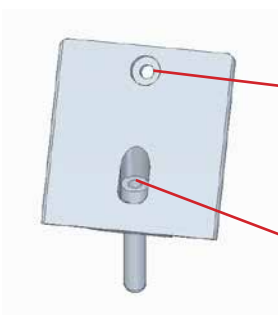

E. Repeat 7A-7D on the other fixed interlocker panel.

8 Threshold Cover Installation:

A. **Install the threshold cover.** Insert the threshold cover end into the sill and press down into place.



9 Vent Panel Installation:

A. **Insert the top of each vent panel into the interior head track** and slide the bottom of the panel into vertical alignment, making sure the rollers are aligned with the sill roller track. Make sure the panels are installed so the handle holes are toward the center of the frame.



9 Vent Panel Installation (continued):

B. **Adjust rollers:** Use a #2 Phillips screwdriver with a 6" shaft to adjust rollers on each side of the panel to ensure smooth operation and even reveal between the vent and joining panels along the length of the panels. Adjust rollers to raise panel far enough so it is not dragging on the sill. Turn the screwdriver to the clockwise to raise the panel and counter-clockwise to lower the panel.

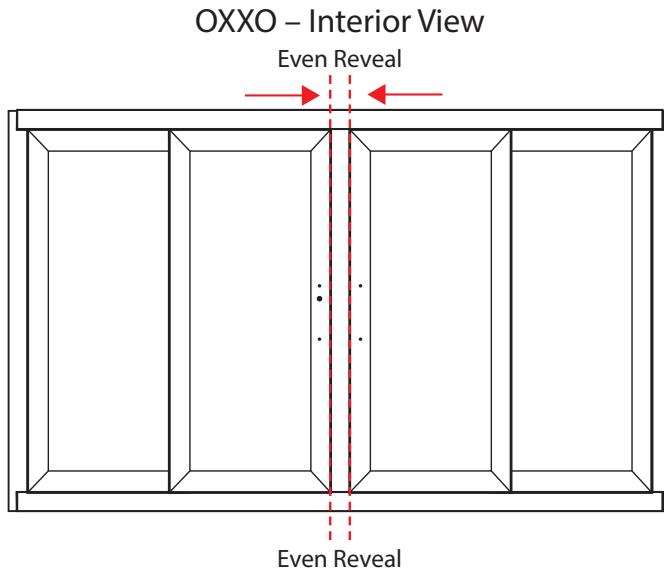

Rollers must be adjusted prior to adjusting the lock strike.

C. **Slide the anti-lift clips** to above the "closed" vent panel position.

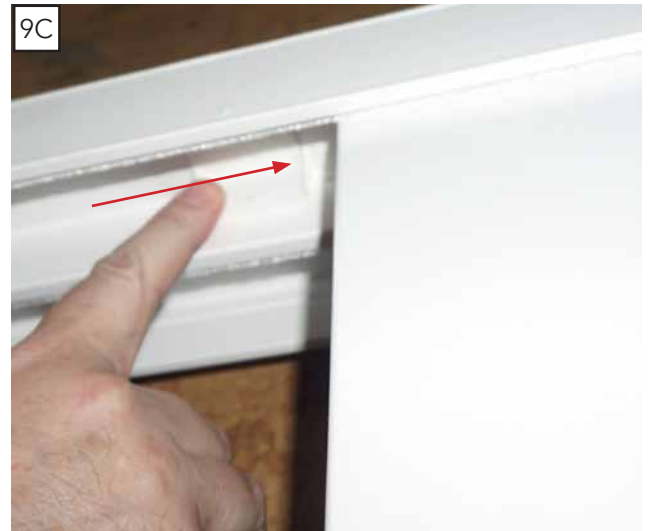

10 Vent Panel Handle Hardware Installation - OXXO:

A. **Use the installation instructions included with the hardware.**

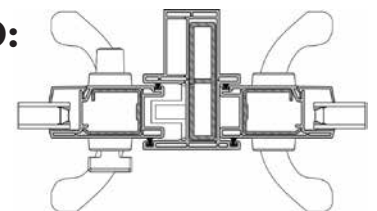

Astragal Installation OVERVIEW:

OVERVIEW / PREVIEW ONLY. OVERVIEW / PREVIEW ONLY. OVERVIEW / PREVIEW ONLY. OVERVIEW / PREVIEW ONLY. OVERVIEW / PREVIEW ONLY.

Overview only, follow process steps on the following page.

The Astragal on an OXXO door is installed on the joining vent panel which the vent panel will close against.

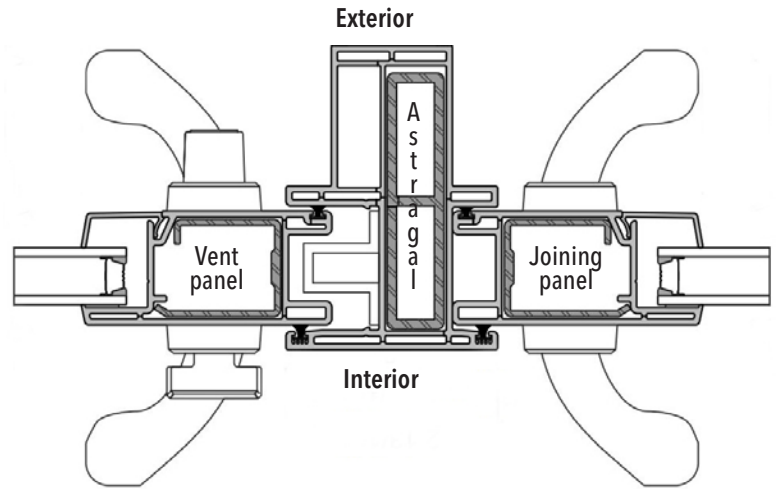

OXXO – Interior View

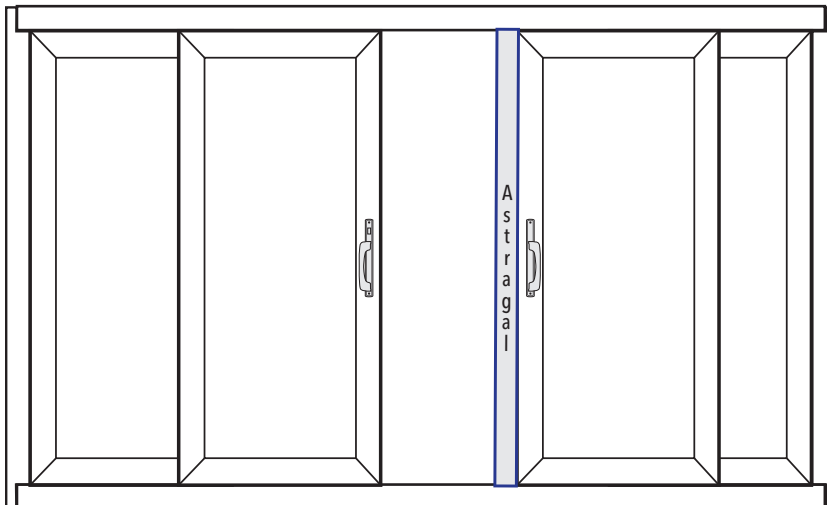
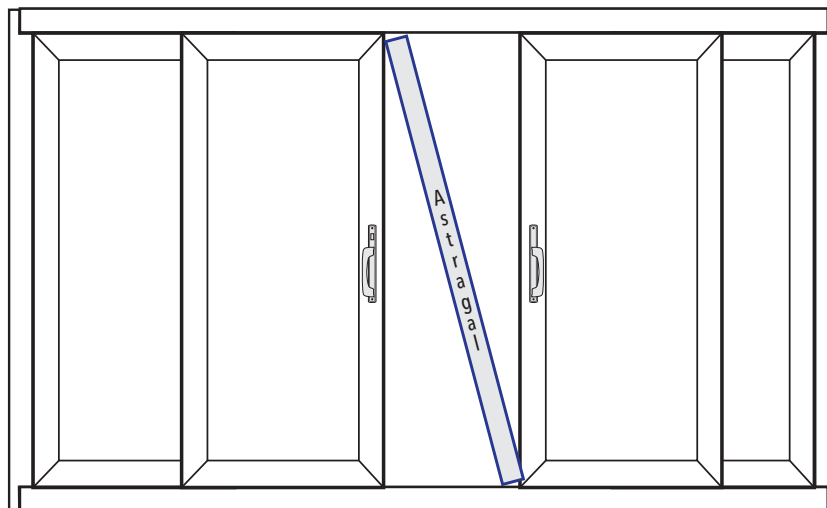

11

Astragal Installation PROCESS:

A. Position the astragal against the joining panel.



B. Place shim(s) under the bottom of the astragal to provide an even gap between the astragal at the top and bottom of the frame.

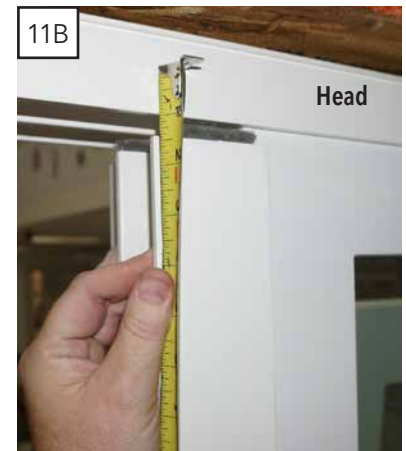

C. Install the #8 x 2-1/4" screw from Bag F through the astragal into the fixed panel at each pre-drilled hole.

Note: Astragal attachment screws are not color matched.



 **Bag F** #8x3/4" & #8x2-1/4" Phillips Panhead Screw - Astragal Lock Strike
V988338 Label part #: 829Y0012 *Pella*



12 Lock Strike Adjustment - OXXO:

A. **Adjust the lock strike on the astragal**, so it aligns with the lock. Lock strike comes attached with screws in the slotted adjustment holes. Loosen these screws to adjust strike up or down to align with vent panel lock. Tighten screws when alignment is complete.



Loosen screws in the slotted holes and adjust strike to align with lock up or down as needed.

Note: the two separate photos below are positioned for alignment demonstration purposes.

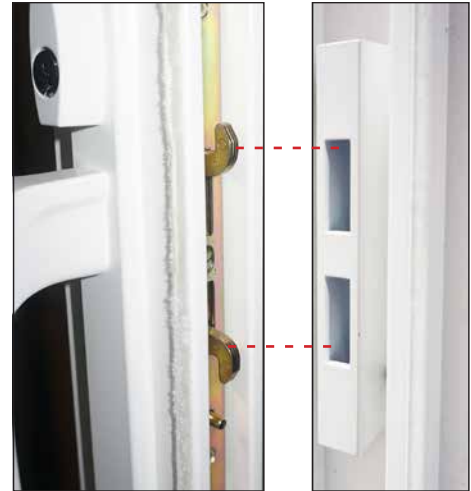

B. **After adjustment; finish installing strike to the astragal** with Qty (4) #8 x 3/4" pan head screws.



Note: OXXO Astragal lock strike screws are not color matched.

